

# FEHRL



Sustainable road  
surfaces for traffic  
noise control



SKANSKA



Guidance Manual for the  
Implementation of Low-Noise  
Road Surfaces

## FEHRL OVERVIEW

FEHRL is a registered International Association with a permanent Secretariat based in Brussels. Formed in 1989 as the Forum of European National Highway Research Laboratories, FEHRL is governed by the Directors of each of the national institutes. At present, FEHRL comprises twenty-nine national laboratories from the member states in the European Union, the EFTA countries and the rest of Europe.

Under the day-to-day management of the Executive Committee, FEHRL is engaged in research topics including road safety, materials, environmental issues, telematics and economic evaluation.

Research capacity is provided by the national institutes and makes use of the wide range of test facilities available.

## AIMS AND OBJECTIVES

The mission of FEHRL is to promote and facilitate collaboration between its institutes and provide high quality information and advice to governments, the European Commission, the road industry and road users on technologies and policies related to roads.

The objectives of collaborative research are:

- to provide input to EU and national government policy on highway infrastructure
- to create and maintain an efficient and safe road network in Europe
- to increase the competitiveness of European road construction and road-using industries
- to improve the energy efficiency of highway construction and maintenance
- to protect the environment and improve quality of life

FEHRL Report 2006/02

Guidance manual for the  
implementation of low-noise  
road surfaces





This Guidance Manual has been prepared as part of the EU Fifth Framework Project “SILVIA – Sustainable Road Surfaces for Traffic Noise Control”.

SILVIA was initiated by FEHRL, with the leadership designated to the Belgian Road Research Centre (Mr Guy Descornet). This document is dedicated to Mr Rod Addis, the former Secretary-General of FEHRL, whose untimely death in 2004 prevented him from seeing the successful conclusion of the project which he so ably supported.

The project consortium brings together 15 partners from both FEHRL and other organisations.



Bundesanstalt für Strassenwesen (Federal Highway Research Institute), Germany (BAST)



Belgian Road Research Centre, Belgium (BRRC)



Dutch Information and Technology Platform for Infrastructure, Traffic, Transport and Public Space, The Netherlands (CROW)



Danish Road Institute, Denmark (Subcontractor for Danmarks Transport Forskning [DTF, Danish Transport Research Institute]) (DRI)



Dienst Weg- en Waterbouwkunde (Road and Hydraulic Engineering Institute), The Netherlands (DWW)



Institut National de Recherche sur les Transports et leur Sécurité (National Institute For Transport And Safety Research), France (INRETS)



ItalGrip, Italy (ITALGRIP)



Laboratoire Central des Ponts et Chaussées (Public Works Research Laboratory), France (LCPC)



M + P Raadgevende Ingenieurs bv, The Netherlands (M+P)



Skanska, Sweden (SKANSKA)



Transportøkonomisk Institutt (Institute of Transport Economics), Norway (TØI)



Transport Research Laboratory, United Kingdom (TRL)



Gdansk University of Technology, Poland (TUG)



Technische Universität Wien (Vienna University of Technology), Austria (TUW)



Swedish National Road and Transport Research Institute, Sweden (VTI)



**FEHRL REPORT 2006/02****Title: Guidance manual for the implementation of low-noise road surfaces****Editor:** Phil Morgan (TRL)**Main Contributors:** Phil Abbott (TRL)  
Bent Andersen (DRI)  
Fabienne Anfosso-Ledee (LCPC)  
Wolfram Bartolomaeus (BAST)  
Hans Bendtsen (DRI)  
Gijsjan van Blokland (M+P)  
Guy Descornet (BRRC)  
Marc Eijbersen (CROW)  
Jerzy Ejsmont (TUG)  
Jürgen Haberl (TUW)  
Jean-Francois Hamet (INRETS)  
Piotr Mioduszezowski (TUG)  
Roger Nilsson (SKANSKA)  
Cristo Padmos (DWW)  
Ernst Pucher (TUW)  
Chiel Roovers (M+P)  
Ulf Sandberg (VTI)  
Nina Sliwa (BAST)  
Knut Veisten (TOI)  
WillemJan van Vliet (DWW)  
Greg Watts (TRL)**Keywords:** Noise, Road, Pavement, Guidance, Classification

Although FEHRL has done its best to ensure that any information given is accurate, no liability or responsibility of any kind (including liability of negligence) is accepted in this respect by FEHRL, its members or its agents.

© FEHRL 2006

ISSN 1362-6019

ISBN 90-9020404-0 / 978-90-9020404-8

All rights reserved. No part of this publication may be reproduced, stored in a retrieval system, or transmitted in any form or by any means, electronic, mechanical, photocopying, recording or otherwise, without the prior written permission of FEHRL.

FEHRL Secretariat: S. Phillips  
Boulevard de la Woluwe, 42  
Bte 3, B-1200 Brussels  
Belgium

Tel: +32 2 775 82 38

Fax: +32 2 775 82 29

E-mail: [info@fehrl.org](mailto:info@fehrl.org)Web site: [www.fehrl.org](http://www.fehrl.org)





# Contents

<b>1</b>	<b>Introduction.....</b>	<b>1</b>
1.1	Overview of the chapters in the Guidance Manual	5
	<b>PART 1: BACKGROUND INFORMATION .....</b>	<b>9</b>
<b>2</b>	<b>The evaluation of noise .....</b>	<b>11</b>
2.1	Physical measures	11
2.2	Perception	12
2.3	Annoyance	14
<b>3</b>	<b>Overview of vehicle and tyre/road noise .....</b>	<b>17</b>
3.1	The sources of vehicle noise	17
3.2	The generation and propagation of tyre/road noise	18
3.3	The characterisation of road surfaces	23
	<b>PART 2: OVERVIEW OF EXISTING LOW-NOISE SURFACES.....</b>	<b>33</b>
<b>4</b>	<b>Review of existing low-noise surfaces.....</b>	<b>35</b>
4.1	Open graded and gap-graded asphalt surfaces	35
4.2	Cement concrete surface treatments	52
4.3	Summary of the effects of low-noise road surfaces	63
<b>5</b>	<b>Review of existing construction and maintenance techniques.....</b>	<b>69</b>
5.1	Existing production/construction techniques	69
5.2	Maintenance on porous asphalt	76
5.3	Maintenance of concrete pavements	79
5.4	Rejuvenators	82
5.5	Cleaning methods	83
5.6	Winter maintenance operations	85
5.7	Recycling of surface courses	89
<b>6</b>	<b>Prospects for the further development of low-noise surfaces.....</b>	<b>93</b>
6.1	Experimental surfaces and surfaces currently under development	93
6.2	Optimising the acoustic performance of low-noise surfaces	100
6.3	Optimising the structural and serviceability performance of low-noise surfaces	103
6.4	Development work on low-noise surfaces carried out within SILVIA	109

<b>PART 3: SPECIFYING THE PERFORMANCE OF LOW-NOISE SURFACES.....</b>	<b>125</b>
<b>7 Overview of measurement methods for acoustic labelling and COP .....</b>	<b>127</b>
7.1 Direct measurements of acoustic performance	127
7.2 Measurements of indirect acoustic performance and other parameters	128
<b>8 Overview of additional methods used in the SILVIA project.....</b>	<b>129</b>
8.1 Mechanical impedance measurements	129
8.2 Rolling resistance measurements	129
8.3 Airflow resistance measurements	130
<b>9 Proposals for a noise classification procedure .....</b>	<b>131</b>
9.1 Reasons behind the need for a classification system	131
9.2 Requirements for the classification system	132
9.3 Labelling procedures in the classification system	133
9.4 Examples of existing national road surface classification and/or procurement systems	135
<b>PART 4: QUANTIFYING THE BENEFITS OF LOW-NOISE SURFACES .....</b>	<b>137</b>
<b>10 Safety and sustainability benefits of low-noise surfaces.....</b>	<b>139</b>
10.1 Safety aspects of low noise road surfaces	139
10.2 Impacts on sustainability	144
<b>11 Cost benefit analysis .....</b>	<b>149</b>
11.1 Introduction	149
11.2 Description of the calculation method	149
11.3 Example of CBA using the spreadsheet	151
11.4 Summary	162
<b>PART 5: THE PERFORMANCE OF LOW-NOISE SURFACES.....</b>	<b>163</b>
<b>12 Factors affecting the performance of low-noise surfaces.....</b>	<b>165</b>
12.1 Roadside development	165
12.2 Road layout	166
12.3 High-speed roads	166
12.4 Traffic composition	167
12.5 Repairs and joints	167
12.6 Weather effects	168
12.7 Studded tyres	169
<b>13 The integration of low-noise surfaces with other mitigation measures.....</b>	<b>171</b>
13.1 Vehicle factors	171
13.2 Noise barriers and earthworks	172

13.3	Façade insulation	173
13.4	Traffic management measures	174
<b>PART 6: ADVICE ON LOW-NOISE SURFACES .....</b>		<b>177</b>
<b>14</b>	<b>Advice on the selection of low-noise surfaces.....</b>	<b>179</b>
14.1	Required noise reduction (maximum or specific in combination with other noise abatement measures)	180
14.2	Acoustic durability - reduction in noise with surface age.	181
14.3	Cost benefit analysis	184
<b>15</b>	<b>Advice on the assessment of surfaces.....</b>	<b>185</b>
15.1	Conformity-of-production (COP) assessment	185
15.2	Routine and/or periodic monitoring of surfaces	186
<b>References.....</b>		<b>187</b>
<b>Glossary of terms .....</b>		<b>203</b>
<b>Glossary of units and symbols.....</b>		<b>209</b>
<b>Glossary of abbreviations and acronyms .....</b>		<b>215</b>
<b>Appendix A.</b>	<b>Measurement methods.....</b>	<b>219</b>
A.1	The Statistical Pass-By (SPB) method	219
A.2	The Close-Proximity (CPX) method	235
A.3	Road Surface Absorption	243
A.4	Road Surface Texture	248
A.5	Measurement methods for additional Surface Characteristics	254
<b>Appendix B.</b>	<b>Procedure for the certification of measurement apparatus .....</b>	<b>259</b>
B.1	CPX trailers and vehicles	259
B.2	SPB measurement apparatus	267
B.3	Absorption measurement apparatus	267
B.4	Surface texture equipment	272
<b>Appendix C.</b>	<b>SILVIA proposals for a classification scheme .....</b>	<b>275</b>
C.1	Introduction	275
C.2	Labelling procedures	276
C.3	COP-testing	290
C.4	Monitoring	299

<b>Appendix D.</b>	<b>Application of the SILVIA classification system .....</b>	<b>301</b>
D.1	Guidance for stakeholders	301
D.2	Determining road surface corrections	305
D.3	Selection of reference surfaces	312
<b>Appendix E.</b>	<b>SILVIA documents included on the CD-ROM .....</b>	<b>315</b>
E.1	Project Deliverables	315
E.2	Other project reports	316

# 1 Introduction

Recent estimates indicate that more than 30% of EU citizens are exposed to road traffic noise levels above that viewed acceptable by the World Health Organisation (WHO) and that about 10% of the population report severe sleep disturbance because of transport noise at night [1]. In addition to the general disruption of activities and quality of life, there are additional adverse health and financial effects.

The WHO has identified a range of specific adverse health effects caused by environmental noise some of which are medically related. Although there are significant problems in establishing a direct causal link between exposure to transport noise and the deterioration in the health of individuals, there is a growing body of research evidence that support the contention that noise and health are related. For example, international literature studies and evaluations carried out in connection with the development of the Danish Road Noise Strategy [2] has shown a relationship between road traffic noise and incidences of high blood pressure and heart disease. The study also estimated that around 800-2200 people in Denmark are admitted to hospital each year with high blood pressure or heart disease due, it is considered by the study authors, to the additional risk brought about by traffic noise. It was also tentatively estimated that between 200-500 people die prematurely in Denmark each year as a result of exposure to high levels of transport noise. It is estimated that the cost of such health effects for Denmark is of the order of €80-450M per year.

In addition to the costs of dealing with health issues, there are other potential costs that can be attributed to high transport noise levels. These include effects on the value of property, loss of amenity due to noise and the costs of control measures and enforcement. In the EU Green Paper on future noise policy published in 1996 [3], it is estimated that in Europe the *external* costs of traffic noise, which take account of such factors as the costs on the quality of life and health effects, are 0.2 - 2% of GNP. In total, therefore, a rather significant part of the economy of Member States is affected by noise impact and noise reduction policies.

It is, of course, difficult to fully evaluate the costs of noise impacts due to the uncertainties in monetising some of the more subjective elements, however, further insight into the magnitude of these costs can be determined from studies of how property values are affected by noise. For example, a study of the influence of road noise on house prices carried out in Spring 2003 by the Danish EPA [4] indicated that house prices were lower by about 1% for each dB increase in noise for houses located near to busy roads. Although it is uncertain how much of this drop in value can be attributed solely to noise impacts, it is clear that noise is a significant ingredient governing property valuations. The total cost of noise to Danish society has been estimated to be between €780M-1150M per year (health effects and reduced house prices).

A study carried out in the UK has examined revisions to the vehicle noise test procedures [5] and included an examination of the costs and benefits of reducing vehicle noise. It was estimated, making a number of assumptions that need to be tested, that the benefit to the UK population of a 1 dB reduction in noise measured at dwellings would be of the order of €800M per year. When this figure was applied to the option of reducing the exposure to traffic noise through the reduction of noise levels from vehicles as part of the type approval process, a minimum cost benefit ratio in excess of 100-1 was found to apply. In

other words the costs of this form of noise control was small in relation to the overall benefits that could be achieved

Clearly, although the absolute costs to society of the impacts of transport noise are difficult to determine with precision, it is clear that since the magnitudes are potentially very large the financial benefits of tackling the problem, irrespective of the benefits attributable to the quality of life, are also likely to be very significant.

The application of road traffic noise mitigation measures to address the problem of road traffic noise is by no means fully developed. Several problems exist, which interfere with the effective control of noise emission from roads. In the EU Green Paper on future noise policy published in 1996 mentioned above, the significant potential for road traffic noise reduction by use of special 'low noise road surfaces' was mentioned as a major issue.

The SILVIA project, "*Sustainable Road Surfaces for Traffic Noise Control*", was initiated with the aim of making it possible to derive the full benefit from this kind of noise control approach. It was anticipated that this would be achieved by:

- Initially solving the problems of evaluation of the actual noise reduction achieved using different road surface designs;
- Evaluating the costs/benefits of different options;
- Demonstrating how low noise surface technology can be integrated with other noise control measures;
- Providing guidance on how the results can be applied in different member states.

This Guidance Manual, produced as the final output of the project, is a compilation of the key research and findings from all of the component Work Packages. The Manual has been written taking into account the fact that it should ideally be possible to make use of the content without any particular expertise in the subject area. The main body of the text has therefore been drafted with the non-expert in mind. However, some detailed technical sections which are needed to implement some of the procedures recommended in the Manual, are attached as Appendices.

**Part 1** of the Manual summarises the basics about noise in general and vehicle noise and tyre/road noise, in particular, in order to provide the reader with the necessary background to the topic.

It is noted that the Manual does not reflect the total amount of information generated over the course of the project. Much of this extra information is offered on the attached CD-ROM. It contains all of the "Deliverables" and most of the intermediate, relevant technical reports produced by the SILVIA Work Packages. The purpose is to provide interested readers, experts, academics, etc. with full access to the scientific and technical results of the project.

This work directly contributes to the policy defined in the Green Paper on Future Noise Policy [3], namely the action proposed to mitigate road traffic noise which reads "*The next phase of action to reduce road traffic noise will address tyre noise and look at the possibilities of integrating noise costs into fiscal instruments, amending Community legislation on road-worthiness tests to include noise and (look) at the promotion of low-*

*noise surfaces through Community funding*". The latter has a wide-ranging potential benefit because building substantially quieter road surfaces does not necessarily incur additional costs. A further important benefit is that controlling tyre/road noise is an example of reducing the noise at the source, which is the most effective approach. Other forms of noise control such as barriers can be costly, less effective and inapplicable in cities, and they are often visually intrusive. Reducing noise at the source may therefore also help to release resources previously committed to noise control at a particular location to enable remedial measures to be taken elsewhere.

One of the main factors that contribute to high levels of tyre/road noise is the surface "megatexture". This characteristic is also responsible for a non-negligible extra fuel consumption due to rolling resistance, which means extra air pollution and in particular the production of additional greenhouse gases. Finally, contrary to common sense, low-noise surfaces do not need to be smooth and hence possibly slippery when wet; many road surface materials and techniques have proven to be relatively quiet as well as highly skid resistant.

Low-noise road surfaces were first experimented with over 40 years ago [6]. Several solutions have been developed that use asphalt, concrete or other materials.

**Part 2** of the Manual presents an overview of the different low-noise solutions for pavements, including well-established surface types and technologies which are relatively new or under development, some of which have been tested within the SILVIA project. It also reviews construction and maintenance techniques used for low-noise surfaces and addresses the possibilities of improving the acoustic performance and durability of low-noise road surfaces.

However, despite these advances, the use of these surfaces is not widespread even though they represent a relatively inexpensive means of reducing traffic noise. The wider use of quieter road surfaces could without doubt improve the quality of life for a significant number of European citizens and at the same time improve perception of the quality of the highway infrastructure, particularly when experiencing improved comfort as a road user.

These benefits can be achieved without affecting the safety performance of the road network; skid resistance will be preserved or even increased by some of the available solutions. Some low-noise surfaces are deemed to be much safer than ordinary dense ones because they improve visibility during wet weather by preventing water splash and spray and preserve skid resistance by draining rainwater away. Surfaces that reduce tyre/road noise emission also reduce the noise inside the cabin of cars (the opposite is not generally true), thus improving user comfort; potential secondary benefits from reducing interior noise include reduction of driver fatigue and improved environment for voice activated equipment. However, the subsequent increase in traffic speed is sometimes said to possibly affect the improvement in accident rates. This underlines the importance of considering each noise countermeasure in a holistic way so that overall the benefits and disadvantages are properly identified and rationalized during the planning and decision taking processes. This is the philosophy underlying this work.

Although modelling techniques for predicting sound emission and propagation models that incorporate the effects of distance, atmospheric sound absorption, meteorological influences (temperature and wind speed gradients) and ground attenuation, are becoming more advanced and increasingly accurate, there are still important methodological problems that require to be resolved for the effects of low-noise pavements to be accurately accounted for. The acoustical performance of a given pavement design cannot

therefore be adequately assessed at present before the pavement is actually constructed on a large scale. Only testing of the finished pavement, either by noise measurements of passing vehicles or using a noise measurement trailer, provides the necessary information about the noise reduction achieved. Furthermore, these methods lack the possibility of absolute calibration that would make the results exchangeable throughout Europe. Laboratory tests of small pavement samples are available but their results cannot be translated into an estimation of the noise reduction of a finished pavement in practice. Part of the solution is to establish or improve prediction models relating the pertinent road surface parameters, e.g. texture profile or acoustic absorption, to noise (or noise variation). This is addressed within the SILVIA project. However establishing methods that allow the acoustic performance of a road surface to be assessed from small laboratory samples lies outside the scope of the SILVIA project, falling instead within the competence of the road constructors.

**Part 3** of the Manual first summarises the different measurement methods that are available for the evaluation of the acoustic performance of a road surface, particularly for labelling and conformity-of-production (COP) assessment. One method is based on measurements of noise from vehicles selected from the traffic stream, and is therefore highly representative of actual traffic noise impacts. However, it is not applicable everywhere. Other methods produce a greater degree of reproducibility but are less representative as they do not measure a large number of vehicle/tyre combinations or only measure tyre noise. The review also includes methods for the determination of other important related parameters such as mechanical impedance and rolling resistance.

A more detailed description of these measurement methods is given in Appendix A, including details of equations developed to allow the use of certain non-acoustic parameters for approximating acoustic performance. Appendix B describes the certification procedures that have been developed within the SILVIA project for noise-related measurement equipment.

The essential chapter in Part 3 is a presentation the “Noise classification procedure” that has been developed to provide the most accurate and reproducible characterization of the acoustic performance of a specific pavement. The procedure – with some variations – has different applications among which is the determination of the correction term for the road surface influence in the vehicle noise source model developed by the HARMONOISE project<sup>1</sup> ([www.imagine-project.org](http://www.imagine-project.org)). The full description of the procedures is given in Appendix C (SILVIA proposals for a classification scheme) and Appendix D (Application of the SILVIA classification system).

Noise control generally cannot be achieved without incurring some costs. The investment by manufacturers in achieving lower noise vehicles is already a substantial component of development costs and similarly, the cost of noise barriers and other highway and land use measures designed to reduce noise impacts is huge. Clearly, the use of the low-noise surfaces studied in this project may also attract costs over conventional approaches in terms of both total construction and maintenance costs.

It is therefore important that the project should address the cost-benefit aspects of low-noise surfaces, considering the full lifecycle and comparing the cost and benefits of the potential noise reduction with the cost and benefits of noise reduction obtained by other

---

<sup>1</sup> The HARMONOISE project (Aug 2001 - Jan 2005) produced methods for the prediction of environmental noise levels caused by road and railway traffic. These methods are intended to become the harmonized methods for noise mapping in all EU Member States.



more traditional measures. In this complex situation, particularly with respect to the technical solutions for traffic noise reduction, it is not obvious which of these solutions will provide the greatest economical benefit. There is a need for a transparent procedure for cost-benefit analysis of noise mitigation measures, which offers comparison of the cost of construction and maintenance for the various measures.

**Part 4** of the Manual deals with the economic aspects related to the use of low-noise road surfaces. This includes consideration of both safety and sustainability issues. A cost/benefit analysis tool developed as part of this project is presented. It describes a calculation procedure for determining the cost/benefit ratio of noise control measures with a focus on low-noise surfaces, and includes a worked example. The method is provided as an EXCEL spreadsheet on the accompanying CD-ROM.

Low-noise pavements are often used in combination with noise barriers, earthworks and other measures without full understanding or control of their combined noise reduction performance. It is often assumed that the overall effects of individual measures may be added without taking into account the frequency dependence, which is different for each measure. When the computations are carried out properly it often appears that the efficiency of a low-noise pavement in the presence of a noise barrier is lower than the mere addition of the individual effectiveness of the pavement and the barrier. In addition, the frequency dependent attenuation during propagation over larger distances leads to a reduced effect of low-noise pavements at larger distances. The road surface does not make any noise by itself; noise results from the vehicle/tyre/road interaction.

**Part 5** of the Manual considers the interactions that can affect the effectiveness – positively or negatively – of low-noise surfaces. The environment or local conditions are important aspects to consider, e.g. the road layout (bends, slopes, roundabouts, crossings, etc.) and some characteristics of the traffic (percentage of heavy vehicles, speed, etc.). Other noise control measures can be used in conjunction with a low-noise surface like noise barriers, façade insulation and traffic management; it is important to know how they interact to be able to make rational use of those measures.

**Part 6** of the Manual is a collection of advice and recommendations derived from the study on how to make the best use of the low-noise solutions for road pavements. They address the decision makers, the road authorities, the contractors, the road engineers as well as the policy makers at national and at European level.

As wide as possible dissemination is the basic SILVIA Consortium's policy. Therefore, no intellectual property protection is foreseen neither for the results of this project nor for the background knowledge brought in or utilized in this project.

## 1.1 Overview of the chapters in the Guidance Manual

The individual chapters can be summarised as follows:

### **PART 1: Background information**

- Chapter 2, “*The evaluation of noise*”, provides an overview of the salient issues relating the physical measures used to describe noise with perception and annoyance;

- Chapter 3, “*Overview of vehicle and tyre/road noise*” provides the background information which describes the various noise sources associated with vehicle noise emission and the important surface parameters that are important for the characterisation of a road surface (in terms of both acoustic and non-acoustic performance).

### **PART 2: Overview of existing low-noise surfaces**

- Chapter 4, “*Review of existing low-noise pavement solutions*”, provides a broad overview of existing low-noise surfaces that are currently used across Europe, including details of material specifications and typical acoustic performance;
- Chapter 5, “*Review of existing construction and maintenance techniques*” provides a broad overview of construction and maintenance methods, including cleaning and winter maintenance;
- Chapter 6, “*Prospects for further developments of low-noise surfaces*” considers how the acoustic performance of surfaces might be optimised by changes to material properties and production techniques, how structural durability might be optimised and reviews some new/recent developments and concepts for low-noise surfaces that are not yet widely accepted for general use.

### **PART 3: Specifying the performance of low-noise surfaces**

- Chapter 7, “*Overview of measurement methods for acoustic labelling and COP purposes*”, provides a summary of the recognised methods that are used within the project for obtaining measurement data and which form an integral part of the SILVIA surface classification system;
- Chapter 8, “*Overview of additional methods used in the SILVIA project*” provides a summary of methods developed within the project that are not yet recognised as standard methods;
- Chapter 9, “*Proposals for a noise classification procedure*”, introduces the need for and outlines the basic measurements required by the SILVIA project classification system for acoustic labelling, COP (Conformity of Production) assessment and routine monitoring.

### **PART 4: Quantifying the benefits of low-noise surfaces**

- Chapter 10, “*Safety and sustainability benefits of low-noise road surfaces*”, summarises current knowledge on the safety aspects of low-noise road surfaces, and the effects of using these surfaces on effects such as water pollution, material use, recycling and fuel consumption. Particular emphasis is placed on porous asphalt surfaces;
- Chapter 11, “*Cost-benefit analysis*”, describes the application spreadsheet cost-benefit tool developed within the project, including worked examples.

**PART 5: The performance of low-noise surfaces**

- Chapter 12, “*Factors affecting the performance of low-noise surfaces*”, addresses the influence of local conditions such as roadside developments, fleet composition, repairs, studded tyres and weather effects on the performance of low-noise surfaces;
- Chapter 13, “*The integration of low-noise surfaces with other mitigation measures*”, describes the influence of other types of noise mitigation measures on the performance of low-noise surfaces.

**PART 6: Advice on low-noise surfaces**

- Chapter 14, “*Advice on the selection of low-noise surfaces*” summarises the conclusions from previous chapters and advises on other considerations such as changes in performance over the surface lifetime;
- Chapter 15, “*Advice on the assessment of surfaces*”, provides a summary of the procedures developed in the project for COP (Conformity of production) assessment and routine monitoring.

**APPENDICES**

- Appendix A, “*Measurement methods*”, provides more details on all of the measurement methods considered or applied within the SILVIA project, both for general measurements and as part of the SILVIA classification system. For the more important methods, the issues of repeatability and reproducibility are also addressed, and equations proposed for converting measurement results to appropriate single number ratings;
- Appendix B, “*Procedures for the certification of measurement apparatus*”, describes recommended procedures for certifying and approving test apparatus used to carry out the methods described in Appendix A;
- Appendix C, “*SILVIA proposals for a classification scheme*”, sets out in detail the procedures and associated tolerances for the acoustic labelling of surfaces, COP assessment and routine monitoring;
- Appendix D, “*Application of the SILVIA classification system*”, describes how the information generated during acoustic labelling might be used to define product specifications for politicians, planners and contracting parties. The derivation of road surface corrections for national noise prediction methods and the associated selection of appropriate reference surfaces are also addressed.
- Appendix E, “*SILVIA documents included on the CD-ROM*”, lists all of the deliverables and other SILVIA-related documents referred to in the Manual that are stored on the accompanying CD-ROM.



## **PART 1: BACKGROUND INFORMATION**

### ***Why are these surfaces important?***

*This Part of the guide provides the background information which enables the importance of the road surface in contributing to environmental noise to be placed in context and also gives an overview of the physical measures used to assess the impact in terms of perception and annoyance.*

*The main noise sources on a vehicle are related to propulsion which includes engine and transmission noise and rolling noise. Provided the vehicle and road surface are well maintained and vehicles do not greatly exceed the maximum legal speed limit, the dominant rolling noise source is from the interaction between the vehicles' tyres and the road surface. This is referred to as tyre/road noise. In the case of light vehicles the tyre/road noise is dominant over the other sources over much of the speed range.*

*The most influential set of parameters affecting tyre/road noise apart from the influence of vehicle speed is that associated with the road surface. In particular, whilst tyre design and vehicle operation affect the levels of noise generated, the design and construction of the road surface can affect both the generation and propagation of noise. The principal factors are the roughness or texture of the surface, the texture pattern and the degree of porosity of the surface structure. The mechanical impedance (stiffness) of the surface may also be relevant for poro-elastic surfaces. These surfaces are designed to deflect more than conventional surfaces when dynamically loaded. Their construction involves the addition of resilient materials such as crumb rubber.*

*An important consideration is understanding the factors which influence noise emissions from these various sources and how they can be controlled. Noise emissions can be affected by meteorological factors such as rain, wind speed and direction and air temperature but these influences fall outside the scope of this guide.*



## 2 The evaluation of noise

Noise is, by definition, sound that is undesired or unwanted by the recipient. Its measurement therefore involves an understanding of the physical attributes of the sound being emitted and the effects that it causes to individuals that are exposed to it. Consequently, the evaluation of road traffic noise involves relating physical measures of the sounds emitted by road traffic with results from attitude surveys designed to assess annoyance or the disturbance that it causes. The evaluation is complex requiring not only an understanding of how sound is generated and propagates but also on the physiology of the human ear, the environment of where and when the sound is perceived and on the activity of the recipient and their attitude towards road traffic and their neighbourhood.

The following sections give a brief overview of the salient issues relating physical measures with perception and annoyance.

### 2.1 Physical measures

Sound is vibrations transmitted in the air and received by the human ear causing the sensation of hearing. The physical measures used to describe this phenomenon relate to the variations in atmospheric pressure caused by a vibrating body. The magnitude of these pressure variations is described as the sound pressure level which forms the basis of a noise scale designed to assess the annoyance or disturbance associated with road traffic noise.

#### 2.1.1 Sound Pressure Level (SPL)

The sound pressure level is the ratio of the mean amplitude of the measured sound pressure,  $p$ , relative to the mean amplitude of the sound pressure that can just be detectable to the human ear,  $p_0$ , normally referred to as the threshold of hearing and equal to 20  $\mu\text{Pa}$ . The pressure variation over the audible range is large, over  $10^6$  Pa at the threshold of pain. To conveniently express sound pressure levels the decibel scale is used to define the sound pressure level,  $SPL$ , as:

$$\text{Sound Pressure Level, } SPL = 10 \log_{10} \left( \frac{p}{p_0} \right)^2 \text{ dB.} \quad (2.1)$$

The audible range of sounds expressed in terms of sound pressure levels (dB) can now be conveniently covered within the range 0 dB (the threshold of hearing) to 120 dB (the threshold of pain).

For the purposes of assessing the noise from road traffic it is important that the rules for combining noise levels from different traffic sources are understood. If two sources of traffic noise of levels,  $L_1$  and  $L_2$ , where  $L_1$  is greater than  $L_2$ , occur together, the resultant noise level can be calculated by adding a correction,  $?L$ , to the higher of the two noise levels,  $L_1$ . The correction is dependent on the difference in level between the two noises,

$D = L_1 - L_2$ . Figure 2.1 shows the relationship between  $\Delta L$  and  $D$ . Where the difference between the two noise levels is zero, i.e. the two levels are identical ( $D = 0$ ), 3 dB(A) is added to either noise level to obtain the combined value. Where there is a 6 dB(A) difference, the combined level is obtained by adding only 1 dB(A) to the higher of the two noise levels,  $L_1$ .

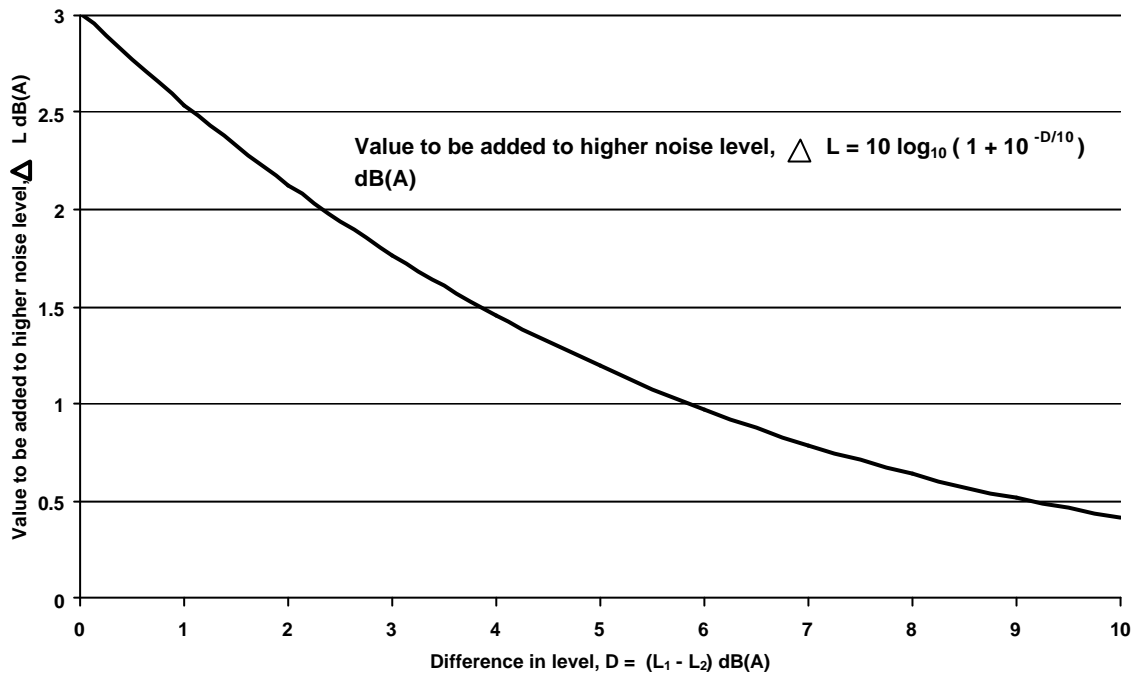

Figure 2.1: Combining two noise levels,  $L_1$  and  $L_2$ : value to be added to the higher level,  $\Delta L$ , as a function of the difference in level,  $D = L_1 - L_2$

## 2.2 Perception

The perception of sound is dependent on the complex physiology of the human ear and its response to variations in sound pressure and to the processing of this information by the brain. The response of the ear to sound depends on the pitch or frequency of the sound wave (Hz), the time taken for the hearing process to respond and to the strength or loudness of the stimuli.

### 2.2.1 Frequency (Hz)

The frequency response of the ear covers a wide range of frequencies from about 20 Hz to about 20 kHz. However, an individual's range of hearing may be much less and dependent on health, occupation and age. The sensitivity of the ear to different frequencies across the audible range is not uniform. Within this range of frequency the sensitivity of the ear changes. For example, hearing sensitivity decreases markedly as frequency falls below about 250 Hz and likewise as frequency increases above about 10



kHz. Unfortunately, the human ear is most sensitive in the frequency range at which tyre/road noise occurs i.e. from about 1 kHz to 5 kHz. It is therefore important that instruments used for assessing noise impacts have a frequency response related to that of the human ear in order for the physical measures of noise to correlate with subjective response. This will be discussed later when loudness is discussed.

### 2.2.2 Response time (seconds)

To respond to variations in sound pressure the hearing system requires a certain time period during which the information is assimilated. The brain acts like an integrator where the perceived incoming stimuli are dependent on previously received information. This process occurs over a very short period of the order of 30 to 300 ms and is dependent on the frequency of the noise [7]. For assessing variations in traffic noise levels typical of where tyre/road noise is the dominant noise source (see Chapter 3) an exponential averaging time period of 250 ms is used in the signal processing of sound level meters to simulate the response time of the human hearing system. This averaging process is often referred to as *FAST* response and typically used for environmental noise assessments where the source noise is not impulsive i.e. or tonal.

### 2.2.3 Loudness (phon)

The loudness of a sound is measured on a scale of units called *phons* and is dependent on both frequency and pressure. For comparison purposes a pure tone at a frequency of 1 kHz and at a pressure of 0 dB i.e. just audible to the human ear, is by definition set at a loudness level of 0 phons. At 1 kHz the loudness level in phons is numerically equal to the decibel level e.g. a sound pressure of 120 dB at 1 kHz will have a loudness level of 120 phons. As explained earlier, because the frequency response of the human ear is not linear with pressure, pure tones at other frequencies and rated as having equal loudness, will have different sound pressure levels. For example, a 100 Hz tone at a pressure of 66 dB is found to have a loudness level of 60 phons i.e. rated as equally as loud as a 1 kHz tone at 60 dB.

The map of equal loudness contours is shown in Figure 2.2, and has been derived from many laboratory experiments on the subjective ratings of loudness. These contours have been used to assist in the development of a frequency response relationship between the rating of loudness and sound pressure levels for types of noises where the sound energy is spread over a wide range of frequencies such as traffic noise. Results from attitude surveys have show that the frequency response described by the 40 phon contour shown in Figure 2.2 is reasonably good at rating the subjective loudness of traffic noise and describes the A-weighting filter response used in sound level meters for assessing the environmental impact of road traffic noise. Noise levels measured on this scale are expressed in units of dB(A).

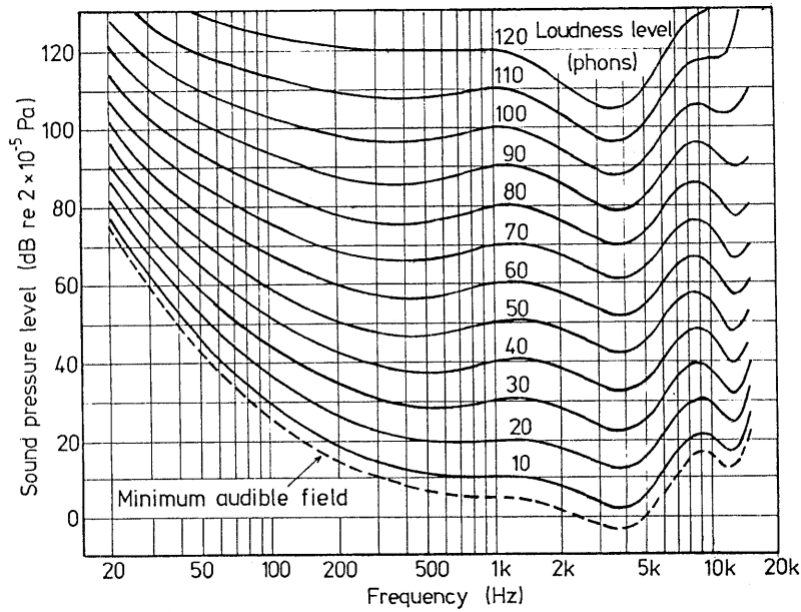

Figure 2.2: Equal loudness contours [8]

## 2.3 Annoyance

The previous sections have described the relationship between the physical measures used to describe noise with how sound is perceived. This understanding has led to the development of instruments for measuring noise such as sound level meters to respond to the variation in noise levels similar to that of the human hearing system. The next stage in the process is to understand the general long-term adverse reaction to the exposure of road traffic noise on communities normally referred to as annoyance and the various methods that have been developed to express it on a simple numeric scale i.e. a noise scale.

### 2.3.1 Noise scale ( $L_{Aeq,T}$ )

The most commonly used noise scale used in Europe for assessing the noise impact from road traffic is the equivalent continuous sound level,  $L_{Aeq,T}$ , which is an energy based measure represented by a steady sound level which, over a defined period of time,  $T$ , has the same A-weighted acoustic energy as the time varying noise level that is typically associated with traffic noise.

An advantage of adopting the  $L_{Aeq,T}$  scale is that it can be described in terms of the time varying A-weighted sound pressure level,  $L_A(t)$  dB(A), using the following formula:

$$L_{Aeq,T} = 10 \log_{10} \left[ \frac{1}{T_2 - T_1} \int_{T_1}^{T_2} 10^{L_A(t)/10} dt \right] \quad (2.2)$$

where providing the time period  $T = (T_2 - T_1)$  is large compared to the averaging time i.e. 250 ms, associated with  $L_A(t)$  is a good approximation and generally satisfied for most practical measurements of traffic noise.

To illustrate the concept of  $L_{Aeq,T}$ , Figure 2.3 shows a typical variation in noise level measured close to a busy road.

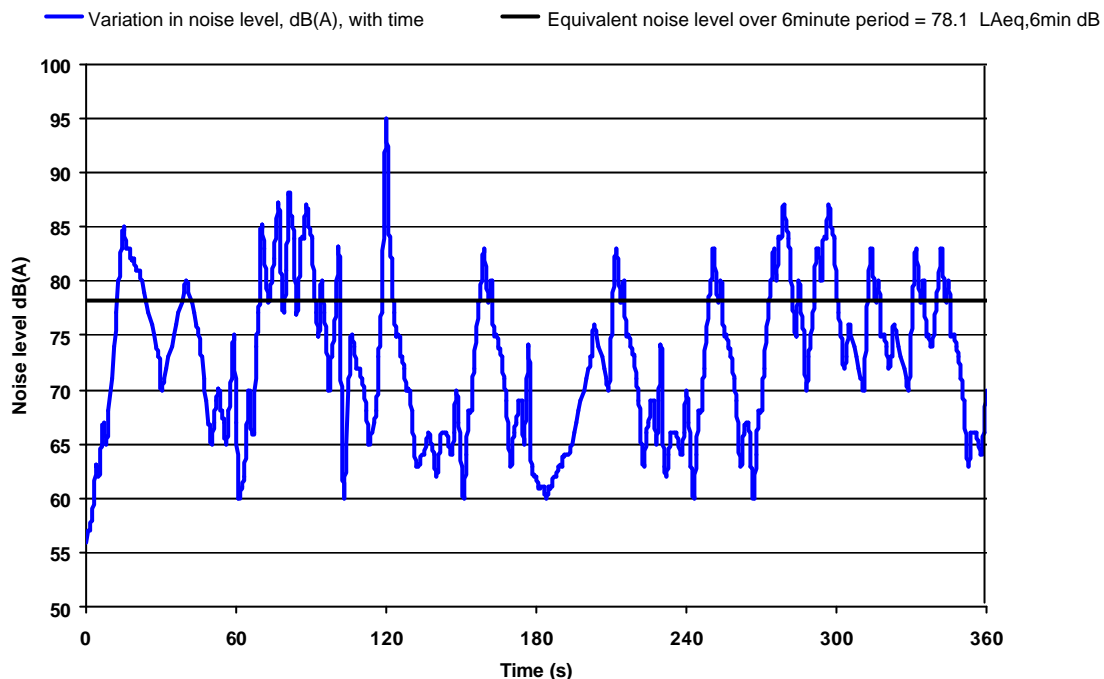

Figure 2.3: Variation in traffic noise level and the equivalent noise level,  $L_{Aeq,T}$  dB

Over the six minute period of recording, the fluctuations in noise levels are shown as vehicles travel past the microphone. The constant level at 78.1 dB depicted in the figure represents the equivalent noise level,  $L_{Aeq,T}$  which over the 6 minute period,  $T$ , has the same acoustical energy as that received from the fluctuating noise from the traffic over the same period.

The factors which contribute to a noise scale, however, are not in general the only factors which may determine annoyance from road traffic noise. Composite measures of noise referred to as noise indices or indicators have been developed which although based on noise scales include additional attributes important for assessing the noise impact on communities. These additional attributes may be related to a particular noise source or characteristic or to certain situations when the noise intrudes. The following provides relevant information on the noise indicators for road traffic noise.

### 2.3.2 Noise indicators ( $L_{den}$ and $L_{night}$ )

Over the past forty years there has been a proliferation of noise indicators that have been shown to correlate reasonably well with community response to annoyance caused by road traffic noise. In November 1996, the European Commission published a Green Paper

on 'Future Noise Policy'. This paper was to be the first step in the development of an overall noise policy with the aim of providing a common basis for tackling the noise problem across the EU [3].

For the purposes of assessing the impact of environmental noise on communities including that from road traffic, the EU has recommended two indicators,  $L_{den}$  and  $L_{night}$ , to be used throughout Europe. Both noise indicators use the noise scale  $L_{Aeq,T}$  as a basic metric but include additional factors concerning the time of day and length of exposure. These indicators are defined as follows:

$L_{den}$  is the primary noise indicator of annoyance from long-term exposure to noise. It is calculated from

$$L_{den} = 10 \times \log_{10} \left( \frac{1}{24} \right) \left( 12 \times 10^{L_{day}/10} + 4 \times 10^{(5+L_{evening})/10} + 8 \times 10^{(10+L_{night})/10} \right) \quad (2.3)$$

where

- $L_{day}$  is the A-weighted equivalent sound level for the 12-hour daytime period from 07:00 to 19:00 hours, determined over all of the day periods of a year;
- $L_{evening}$  is the A-weighted equivalent sound level for the 4-hour evening period from 19:00 to 23:00 hours, determined over all of the evening periods of a year;
- $L_{night}$  is the A-weighted equivalent sound level for the 8 hour evening period from 23:00 to 07:00 hours, determined over all of the night periods of a year.

In equation (2.3)  $L_{evening}$  and  $L_{night}$  have a 5 and 10 dB weighting applied respectively to take account of the difference in annoyance due to the time of day.

$L_{night}$  is used for the assessment of sleep disturbance but does not include the 10 dB weighting that is applied when determining  $L_{den}$ .

It should be noted that the start of the daytime period (and subsequently the start of the evening and night-time periods) are set by individual Member States and that there is the flexibility to shorten the evening period by one or two hours and lengthen the day and/or night period accordingly.

These recommendations form the basis of the EU Directive for assessing the environmental impact of road traffic noise on communities [9]. The importance of this Directive is that it sets out the procedures to adopt in the production of noise maps and the drawing up of action plans to reduce noise exposure. It is anticipated therefore that the utilisation of low noise surfaces will play an important role in the implementation of action plans by Member States as a means to reduce exposure from road traffic noise.

The noise indicators described above show the importance of the time of day when the noise occurs on disturbance. At night there is a 10 dB weighting applied to the overall traffic noise level to take account of the sensitivity of people to noise particularly when they are trying to get to sleep and prior to waking. Although traffic flows during the night are lower and less congested, vehicle speeds are generally higher and the dominant noise is generated by tyre/road noise, particularly on high speed roads. It is therefore important when evaluating the benefits of low-noise surfaces that the impact takes into account the changes in the sensitivity of people to noise particularly with respect to the time of day when the noise occurs.

## 3 Overview of vehicle and tyre/road noise

Road traffic noise is the accumulation of noise emissions from all vehicles in the traffic stream. Each vehicle has a number of different noise sources which when combined give the total vehicle noise emission. This Chapter of the Guidance Manual provides the background information which describes the various noise sources associated with vehicle noise emissions. An important consideration is understanding the factors which influence noise emissions from these various sources and how they can be controlled. In particular, noise sources associated with the interaction of the vehicle tyres with the road surface, often referred to as tyre/road noise, will be highlighted including its generation, propagation and its significance on overall traffic noise. Noise emissions can be affected by meteorological factors such as rain, wind and air temperature but these influences fall outside the scope of this guide.

### 3.1 The sources of vehicle noise

The main noise sources on a vehicle are the power unit (engine, air inlet and exhaust), cooling fan, transmission (gearbox and rear axle), tyre/road surface interaction, aerodynamic, brakes, body rattles and payload. In general, sources associated with the power unit and transmission up to the layshaft are referred to as propulsion noise. All other sources are referred to as rolling noise. Providing the vehicle and road pavement are well maintained and vehicles do not greatly exceed the legal speed limit, the dominant rolling noise source is from tyre/road noise.

The relative importance of propulsion noise and tyre/road noise depends on the type of vehicle, the vehicle's speed, the way the vehicle is driven and the acoustic performance of the road surface. Propulsion sources are primarily controlled by the vehicle's engine speed whilst tyre/road noise is controlled by the vehicle's road speed (see Appendix D for further information).

A method for estimating the reduction in traffic noise levels based on the Statistical Pass-By (SPB) method is provided in Section A.1 of Appendix A.

For situations where traffic is congested and where vehicles are not travelling at constant speed, the contribution from propulsion noise sources will be more important and therefore, for these conditions, the acoustic benefits from low-noise surfaces tend to be reduced.

An important factor which influences tyre/road noise is the design of the tyre where tread pattern, materials and construction together with the overall width are important contributing elements. However, apart from the influence of vehicle speed, the other set of parameters affecting tyre/road noise is that associated with the road surface. In particular, whilst tyre design and vehicle operation affect the levels of noise generated, the design and construction of the road surface can affect both the generation and propagation involving several complex mechanisms. The principal factors are the roughness or texture of the surface, the texture pattern and the degree of porosity of the surface structure. The latter governs the degree of sound absorption.

The following section discusses the mechanisms associated with the generation and propagation of tyre/road noise.

## 3.2 The generation and propagation of tyre/road noise

Tyre/road noise is the result of a complex interaction between the rolling tyre and the road surface. It is a major cause of noise from road traffic particularly for vehicles travelling at moderate to high road speeds as illustrated in the previous section. Clearly, in order to design low noise road surfaces with both predictable and optimised noise reducing properties it is necessary to obtain a thorough understanding of the mechanisms governing the generation and propagation of tyre/road noise.

The references cited in the following sections of this chapter of the manual have been selected to illustrate approximately when the mechanisms governing the generation and propagation of tyre/road noise were first investigated. Clearly, these mechanisms have been well understood for many years and much progress has been made in the intervening years to optimise the acoustic benefits of low-noise surfaces. A comprehensive bibliography of the research carried out in this field has been published recently [10].

### 3.2.1 The mechanisms of tyre/road noise generation and amplification

Tyre/road noise is considered to result from a combination of physical processes that are categorised by convention into three distinct classes of mechanism. These are:

- **Impacts and shocks** caused by the variation of the interaction forces between the tyre tread and the road including the vibrational response of the tyre carcass;
- **Aerodynamic processes** between, and within, the tyre tread and road surface;
- **Adhesion and micro-movement effects** of tread rubber on the road surface.

The main mechanisms described above are illustrated in Figure 3.1, which shows the various stages of tread pattern rotation and the different noise generation effects at each stage of the process.

It is reckoned that for standard rolling conditions the tyre/road noise is mainly composed of "impacts and shocks" noise and "air pumping" noise, with the first mainly occurring below 1000 Hz and the second mainly occurring above 1000 Hz.

#### 3.2.1.1 Impacts and shocks

This mechanism essentially consists of the excitation of the tyre tread elements as they come into contact with the road surface, the vibrational response of the tyre carcass, and the subsequent radiation of sound by an area of the vibrating tyre [11].

As the tyre rotates there are no forces acting upon the tread block under observation.

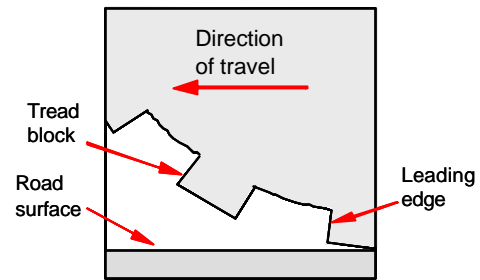

As the tread block impacts with the road surface, shocks are sent through the block which generates vibrations. Air caught between individual tread blocks is compressed

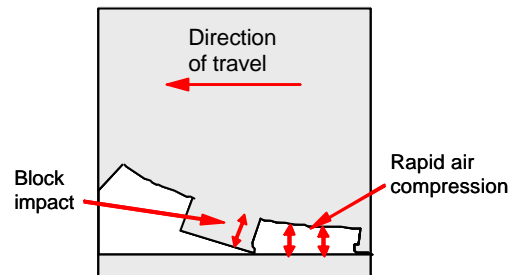

The air trapped between the tread blocks is compressed and decompressed as the tyre passes over the road surface. This is known as "air pumping". Organ pipe resonance occurs in the longitudinal tyre grooves. Friction forces acting on the tread blocks in contact with the road surface cause the "slip-stick" effect.

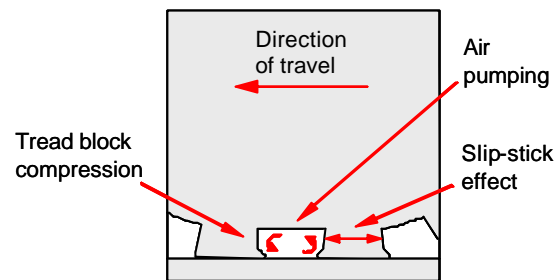

As the tread block leaves the contact patch, compressed air in the tread cavity is expelled rapidly, resulting in the "air pumping" effect. The tread block itself is returned to its undeflected rolling radius position by "snapping out" from the compressed state in the contact patch.

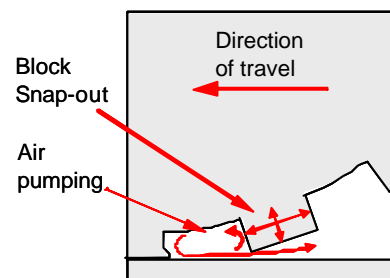

Noise generated at the contact patch is amplified by the geometry of the tyre and road surface (the "horn effect"). The tread block returns to its steady state as the tyre rotates.

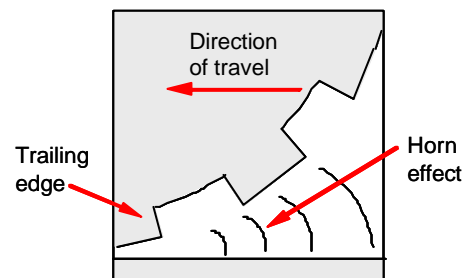

Figure 3.1: The mechanisms of tyre/road noise generation

Vibrations are generated in vehicle tyres by the impacts and deflections that occur as the tread blocks enter and leave contact with the road surface, and as a result of movement of the tread elements in contact with the road base. A tread block entering the contact patch impacts the road surface, generating vibrations which are driven radially into the tyre. The tension exerted on the tread block then decreases and increases depending on the frictional forces between the tyre and road whilst the block is passing through the contact patch. As the trailing edge of the block leaves the contact patch, it is released from this tension and rapidly returns to its undeflected rolling radius. The rapid movement occurring during this process, known as block “snap out”, excites both radial and tangential vibration modes in the tyre structure [12].

Noise that is generated by the tyre as a result of vibrations caused by tyre impacts and “snap out” effects tends to occur towards the lower end of the frequency range below about 1000 Hz. In this frequency range it is known that the amplitude of the longer texture wavelengths in the road texture profile have an important role in controlling noise emissions as explained further in Section 3.3.1.1.

It should be noted that the mechanisms described above are intended to provide a general overview of how noise is generated by a tyre rolling over a road surface. The relative importance of each mechanism in governing the overall levels of noise generated will, in practice, vary greatly between tyre types and designs. For example, the noise generated by truck tyres tends to be more closely related to tangential excitation of the tread than for car tyres where the main mechanisms are often related to excitation of the tyre structure through the generation of normal forces on the tyre belt.

### **3.2.1.2 Aerodynamic processes**

Noise is generated by several mechanisms related to the movement of air in the cavities of the tread pattern. These occur principally in the region of the contact patch. Of these processes the most commonly cited is referred to as “air pumping”.

The original air-pumping theory was described by Hayden [13]. This involves the sudden outflow of air trapped in the grooves of the tread pattern or road surface texture when the tyre comes into contact with the road surface, and the sudden in-flow of air when the tyre lifts away from the contact area. It has also been suggested that friction and tangentially excited vibrations could play a role in exciting air-pumping or “air resonant radiation” [14, 15]. The air pressure modulations caused by these processes have been shown theoretically to cause significant levels of tyre/road noise, particularly when the surface is non-porous and relatively smooth [16]. The provision of air paths in the road surface layer (i.e. porous and semi-porous surfaces) can help to dissipate air trapped in the tread grooves and therefore largely prevent air pumping occurring.

Sandberg [17] has also discussed the possibility of noise generation being affected by air resonance in the cavities of the tread pattern by a process similar to the action of a Helmholtz resonator. The phenomenon occurs when the dimensions of the cavities are small in comparison to the wavelengths of sound and is analogous to the resonance of a mechanical system.

Cena and Travaglio [18] have also described an “organ pipe” effect that occurs due to resonances in the air trapped in the longitudinal grooves in the contact patch. This interpretation was first put forward in 1979 [19]. It is suggested that the mechanism becomes important when the length of the contact patch coincides with half the



wavelength of sound in the air. For car tyres these resonances generally occur at frequencies greater than 1700 Hz.

A similar process may be responsible for a cavity air resonance effect reported by Cena and Travaglio [18] which occurs as a dull drumming noise. The phenomenon arises in the toroidal air space within the tyre. It appears that the interior of the tyre can be considered as a pipe which is bent back on itself. Typically, for a car tyre the main resonances occur at approximately 250 Hz. Vibrations transmitted through the tyre from the contact patch trigger the process.

In general, noise generated by aerodynamic mechanisms tends to be important in the range of frequencies between 1000 and 2000 Hz. In this frequency range it is known that the amplitude of the shorter texture wavelengths in the road texture profile have an important role in controlling noise emissions as explained further in Section 3.3.1.1.

### 3.2.1.3 Adhesion mechanisms

A further noise generation mechanism is caused by tyre vibrations induced by the frictional forces created in the contact patch between the tyre and road surface. When the tyre flattens in the contact patch, the continually changing radial deflection produces tangential forces between the tyre and road. These forces are resisted by friction and tyre stiffness, and any residual forces are dissipated by slip of the tread material over the road surface.

Forces comprised of hysteresis and adhesion components control friction between the tread and the surface. The adhesion component has its origins at a molecular level and is governed to a large extent by the small-scale roughness characteristics, or microtexture of the road surface. During relative sliding between the tyre and the road base, the adhesion bonds that have been formed between the tyre and road surface begin to rupture and break apart so that contact is effectively lost and the tyre element is then free to slip across the road surface. Contact may be regained as these residual forces are dissipated.

The hysteresis force is due to a bulk phenomenon which also acts at the sliding surface. In the contact zone, tread rubber drapes around asperities (i.e. microtexture) in the road surface and, in the absence of slip, the pressure distribution around each asperity is roughly symmetrical. When slip occurs, tread rubber tends to accumulate at the leading edges of these surface irregularities and begins to break contact on the downward slope of the surface profile. This gives rise to an asymmetric pressure distribution and a net force which opposes the sliding motion; at high speeds this force is largely responsible for the tread element regaining contact with the road surface. The hysteresis component of tyre/road surface friction is largely controlled by the surface macrotexture, which comprises texture wavelengths corresponding to the size of the aggregate used in the surface material.

Clearly, the slippage of tread elements alone cannot give rise to tangential vibrational excitation of the tyre. It is rather the combination of the slip of the tread elements as adhesion is lost in the contact patch and a build up of the hysteresis frictional force as deformation of the tread occurs. This gives rise to a "slip/stick" process in the contact patch and the associated vibration excitation of the tyre. Tyre vibration, and hence noise, generated by this mechanism has been related to the slip velocity of the tread elements [20]. The highest velocities tend to be found to the rear of the contact patch and may contribute to block "snap out" effects as the tread elements are released from the contact patch and return rapidly to the undeflected rolling radius of the tyre.

It has also been suggested [21] that a surface with high friction (microtexture or adhesion) can generate high frequency noise due to the excitation of “air resonant radiation” in the contact patch tread grooves. It would appear that this relates to the coincidence of high frequency noise generated due to the rapid slip/stick mechanism of the tread block with the resonant frequencies of the tread cavities and grooves.

#### **3.2.1.4 Amplification**

Noise generated at or near the contact patch can be exaggerated due to the shape of the region between the tyre and road surface immediately to the rear (or front) of the contact patch. In this region multiple reflections between the tyre and road surface occur which focus the sound. The process is referred to as the “horn effect” [22]. Laboratory studies by Schaaf and Ronnenberger [23] investigated the influence of the horn effect by measuring the noise levels from an omni-directional impulsive noise source placed close to the rear of the contact patch of a stationary tyre. The measurements were then repeated with the tyre removed and the differences between noise levels across the spectral range determined. The largest amplifications were reported to occur in the region of 2000 Hz. Amplification of the noise levels measured at this frequency and to the rear of the contact patch, where the influence was found to be greatest, was found to be 22 dB(A). It was found that substantial amplification occurred at frequencies from 1000 Hz up to approximately 10 kHz [24].

### **3.2.2 Tyre/road noise propagation**

In general, noise radiating from a sound source into a free space attenuates with distance from the source with the rate of attenuation dependent upon the shape of the wavefront. For an idealised acoustic point source the sound waves propagate along a spherical wavefront and the sound pressure decreases according to the inverse square law. Although road vehicles cannot be described as acoustically ideal point sources a similar attenuation function can be obtained at relatively long distances from a road for isolated vehicle noise with however important limitations.

When a source and a receiver are located above a flat surface, reflections from the ground plane occur. When the surface is perfectly reflective, the reflected acoustic ray appear to come from an image source located below the surface of the ground, as shown in Figure 3.2(a). When the surface layer is porous, additional factors may need to be taken into account. Figure 3.2(b) shows the principal acoustic ray paths governing wave propagation from a source to the receiver located above a porous surface layer.

To determine the acoustic field strength at the receptor for both these situations it is necessary to determine the phase and amplitude of the direct and reflected waves and then combine these components taking account of any phase interactions (i.e. interference) that occur. The important factors affecting this combination are the type of ground (which, if porous, can have a significant effect on the phase of the reflected waves), the source and receiver heights and the source-to-receiver distance.

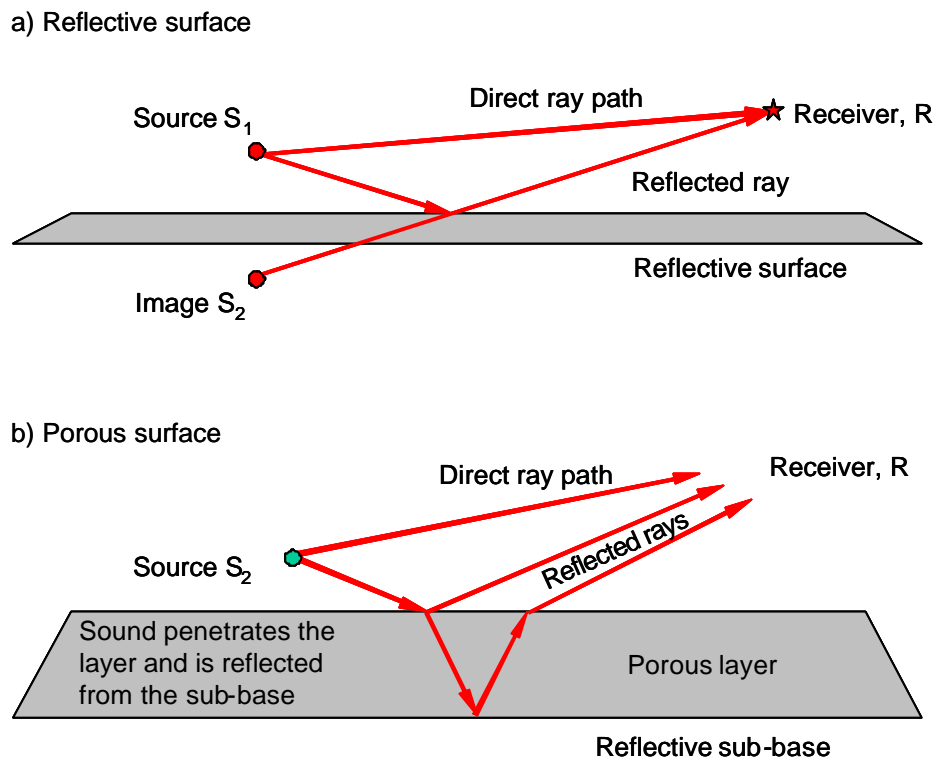

Figure 3.2: Geometry for a source and receiver in the vicinity of a ground plane

For a highly reflective surface (i.e. with low porosity) and when the path difference between the direct and reflected wave is small, then interference only occurs at relatively high frequencies and can be ignored for most practical applications. Under these conditions the sounds arriving from the two paths will add together to give a 6 dB(A) increase over the free field for point source radiation. When the surface layer is porous, or where the path length difference is large, then interference will occur at lower frequencies and typically, for vehicle noise source-to-receiver geometries, destructive interference will generally occur in the frequency range 250-1000 Hz. The frequencies and amplitudes of these important interference effects depend greatly upon the acoustical properties of the surface layer and the angle of incidence of the reflected wave.

### 3.3 The characterisation of road surfaces

The following sections deal with the surface parameters that are important in characterising a road surface and which not only influence the surface's acoustic performance but also rolling resistance, skid-resistance and surface durability.

As an introduction, the influence of surface texture, in particular, the way it is defined and the range of textures which have an influence on the different surface parameters is first discussed.

The road surface profile can be visualised as a continuous series of peaks and troughs which may typically be randomised or alternatively reasonably well defined as in the case

of transverse textured surfacings. Nevertheless, any type of profile shape can be described as the summation of a number of sinusoidal variations differing in both amplitude and wavelength. This process of reducing a complex profile shape into its component cyclic waveforms is known as “Fourier Analysis”, each waveform has associated with it a texture amplitude ( $a$  mm) and texture wavelength ( $\lambda$  mm).

Work carried out by Sandberg and Descornet [15] and later developed by PIARC [25] have identified certain ranges in texture wavelengths which are influential on the surface characteristics related to noise, tyre rolling resistance and skidding resistance. The results of this work are summarised in Figure 3.3.

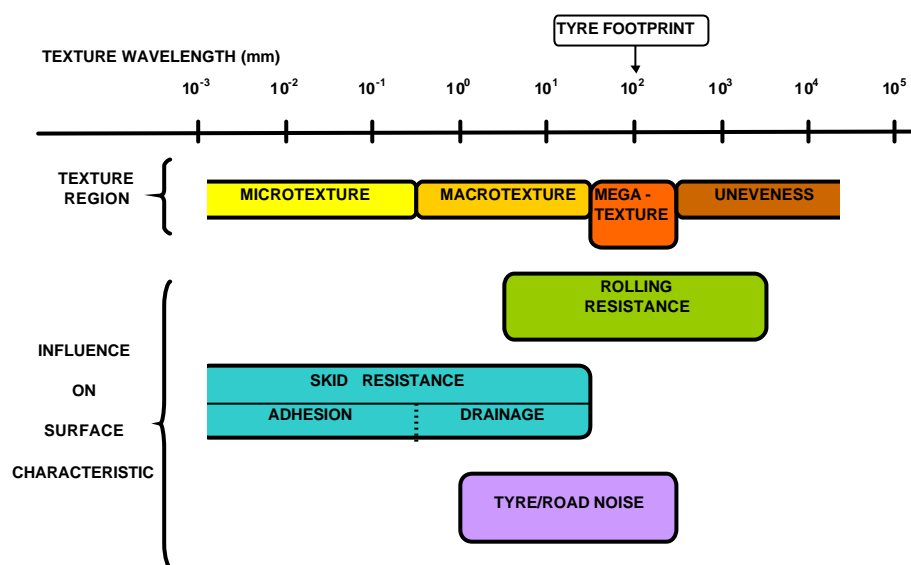

Figure 3.3: Influence of surface texture on the characterisation of road surfaces

It was found that that it is convenient to divide the range of texture wavelengths into four regions, shown in the upper half of Figure 3.3. These texture regions have been defined by the texture wavelength ( $\lambda$  mm) of the surface irregularities as follows:

- Microtexture:  $\lambda < 0.5$  mm;
- Macrotecture:  $0.5 \text{ mm} < \lambda < 50$  mm;
- Megatecture:  $50 \text{ mm} < \lambda < 500$  mm;
- Unevenness :  $\lambda > 500$  mm.

The lower half of Figure 3.3 illustrates the approximate range in texture wavelengths which influence surface parameters including rolling resistance, skid resistance and tyre/road noise. For example, texture wavelengths in the macro- and megatecture range i.e.  $0.5 \text{ mm} < \lambda < 500$  mm, are important for controlling tyre/road noise. The figure also shows that texture wavelengths in this region are also important in controlling both rolling and skid resistance. Clearly, an understanding of the relationship between texture wavelength and the various surface parameters described in Figure 3.3 provides the basis for characterising road surfaces that provide lower noise levels without compromising durability and, importantly, skidding performance and safety.

The following section examines the surface properties which are most important in controlling the acoustic performance including texture, porosity and stiffness. This is followed by a section which examines the importance of other properties which influence rolling resistance, skid resistance and durability.

### **3.3.1 Properties affecting acoustic performance**

The acoustic performance of road surfaces is influenced by a number of surface properties the most important are discussed in some detail below. Other surface parameters such as the way the surface material affects heat radiation/absorption and whether the surface is wet or dry can influence acoustic performance but their influence is either secondary or they are not related to road surface specification. Therefore, these parameters are not dealt with in this manual.

#### **3.3.1.1 Texture**

The relationship between surface texture and tyre/road noise is complex. It has been shown earlier that texture wavelengths in both the macro- and megatexture range influences the generation of tyre/road noise.

Research has shown that increasing texture amplitudes at wavelengths in the range 0.5 to 10 mm may reduce noise generation particularly at high frequencies generally above 1 kHz [15]. Texture wavelengths in this range accord with dimensions associated with the small asperities in the surface which are thought to have an influence on the aerodynamic mechanism of tyre/road generation, particularly air pumping (see Section 3.2.1.2, above). Increasing texture amplitudes at wavelengths in the range 0.5 to 10 mm reduces the air resonating in the grooves of the tread pattern of the tyre and the surface of the road as the tyre passes through the contact patch. The increase in texture allows the air trapped between the tyre and the road surface to be released less suddenly and therefore generates less noise.

In addition to this high frequency noise effect there is a low frequency component which behaves differently. Increasing texture amplitudes at wavelengths in the range 10 to 500 mm causes noise levels to increase, particularly at frequencies generally below 1 kHz. The tyre mechanism affected by texture amplitudes in the 10 to 500 mm wavelength range is thought to be associated with tyre tread impacts with the road surface (see Section 3.2.1.1 above). As the texture increases, the vibration levels set up in the tyre carcass due to the tread impact increases causing higher levels of noise to be generated, particularly at frequencies below 1 kHz.

A further important consideration with respect to texture is in the way the texture is applied. The relationship between texture amplitudes in the megatexture range with noise is different for randomly textured surfaces than compared with surfaces with a transverse texture such as brushed concrete. Figure 3.4 illustrates this effect for a range of surfaces identified with either transverse or random textures.

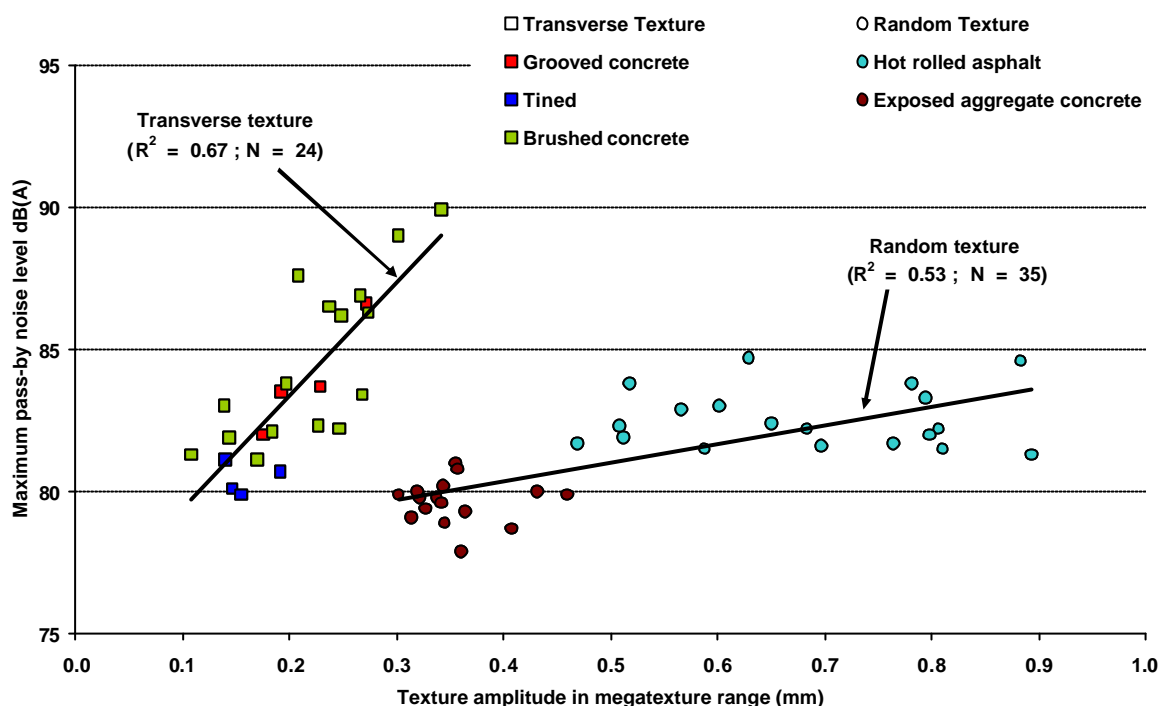

Figure 3.4: Variation in vehicle pass-by noise level and texture amplitudes in the megatexture range for typical light vehicles travelling at 90 km/h at 7.5 m

The figure shows the results from measurements of vehicle pass-by noise levels derived using the Statistical Pass-By (SPB) method [26] and typical for light vehicles travelling on medium to high speed roads. The figure shows that for both transverse and random texturing for a range of surface types, the maximum pass-by noise levels are well correlated with texture amplitudes in the megatexture range. Clearly the regression lines drawn through the data corresponding to the method of texturing are very different, showing that noise levels on transverse textures are significantly higher for a given amplitude compared with corresponding noise levels for randomly textured surfaces.

The explanation for this effect is that the forces acting on a tyre travelling on a transverse texture are more synchronised across the width of the tyre than for random texturing and therefore enhance higher vibrations in the tyre and produce more noise. A similar result has been found for heavy vehicle pass-by noise levels [27].

The ways in which texture is formed also differ in the vertical plane and, in this report, the terms *positive* or *negative* are used to describe them:

*Positive* texture is formed by particles or ridges which protrude above the plane of the surface. Typically, such textures are formed by applying chippings to an essentially smooth surface and rolling them (as in rolled asphalt or surface dressing, for example). Positive texture may also be formed by removing the surrounding matrix to expose aggregate particles (such as in exposed-aggregate concrete or a weathered asphalt). The term also describes the texture formed on transversely brushed concrete;

*Negative* texture is a term often applied to materials in which the texture largely comprises voids between particles whose upper surfaces form a generally flat plane, typical of thin

surface systems. It can also be used to describe grooved concrete, especially where the grooves have been sawn after the original brush-marks have been worn away by traffic.

Depending on the size of the chippings, positive texturing encourages higher levels of vibration in the rolling tyre while negative textures contribute to the lower noise levels associated with thin surfacing systems.

### 3.3.1.2 Porosity

It was shown earlier in Section 3.2.2 how porous surfaces play an important role in reducing the noise propagated away from the road by sound absorption. But porous surfaces also reduce the generation of noise by several mechanisms related to the surface *porosity*.

A measure of porosity can be defined as the percentage of voids that are open to the air in a given volume of total pavement mix, sometimes referred to as the residual air void content,  $\Omega$ . Although defining a porous surface in terms of its void content has not been internationally established the following guide has been suggested by members of the SILVIA consortium:

- Dense layers (air void 4-9% )
- Semi-dense (air void 9-14%)
- Semi-open (air void 14-19%)
- Open layers (air void over 19%) which are porous layers

Increasing the porosity of the surface reduces the compression and expansion of air trapped in the tyre tread, reducing the noise generated by aerodynamic mechanisms (see Section 3.2.1.2). Porosity is also important in sound absorption: increasing the porosity generally increases the acoustic absorption and, by consequence, reduces the horn effect (see Section 3.2.1.4).

Porosity is not, however, the only parameter that influences sound absorption. Additional parameters have been identified from results of modelling sound absorption effects [28, 29] and include:

- *Thickness of the porous layer* ( $d$  m) which influences where the maximum absorption occurs in the frequency spectrum. Increasing layer thickness lowers the fundamental frequency of maximum absorption together with its harmonics;
- *Air flow resistance* is important in governing the air flow in the pores of the surface. A high air flow resistance is favourable to sound energy dissipation, but a too high air flow resistance prevents the acoustic waves to penetrate into the layer. The optimum range of the air flow resistance depends on the thickness of the layer. It can be shown that the shape of the absorption curve in the frequency domain depends on the total air flow resistance of the layer, i.e. on the product of the specific air flow resistance of the porous medium by the thickness of the layer [30];
- *Tortuosity* is a measure of the curved/meandering nature of the air path through the surface layer. In practice the air path through the layer will be dependent upon the shape of the interconnecting voids. The more tortuous the air path, the lower

the fundamental frequency of maximum absorption. The fundamental frequency is therefore governed by both the tortuosity and the layer thickness [29].

Results from a number of different sources when combined, indicate that the noise reduction of porous surfaces is statistically highly correlated with the product of residual air voids and layer depth ( $\Omega d$ ). As the product  $\Omega d$  increases the noise also increases in a roughly linear fashion. The relationship appears to hold for values of  $\Omega d < 30$  mm (when  $\Omega d$  is expressed as a fraction). By taking into account the size of the aggregate, improvements in the correlation are obtained, i.e. surface with similar  $\Omega d$  but with smaller chippings provide greater noise reductions. For values of  $\Omega d$  above about 30 mm there was found to be no significant increase in noise reduction [10].

### 3.3.1.3 Stiffness

The property of the surfaces referred to as the mechanical impedance or stiffness of the surface has also been associated with noise generation relating to impact mechanisms. Generally the mechanical impedance of the road surfaces is several orders of magnitude higher than that of the rubber in the tyre tread. Lowering the road mechanical impedance will tend to reduce the tread block impact forces transmitted into a tyre which in turn will reduce tyre vibration levels and hence noise generation. This seems to be the case of surfaces made of poro-elastic material which are designed to have a rubber content of at least 20% by weight.

## 3.3.2 Non-acoustic properties

The surface parameters that have been discussed above have been related to the acoustic properties of the surface. However, the overall performance of a road surface needs to consider other parameters relating to safety, fuel economy and overall cost-life benefits which should not be sacrificed purely to reduce noise. The aim of this section is to discuss these non-acoustic properties of the surface and to identify how they may influence acoustic performance.

### 3.3.2.1 Skid-resistance

Road surfaces are primarily provided with surface texture in order to provide a safe running surface that provides adequate resistance to skidding particularly when the road surface is wet. For dense surfaces the microtexture helps break down the surface film of water whilst the macrotexture helps “store” excess surface water thereby improving the contact between the tyre and the surface and preventing aquaplaning. Porous surfaces provide additional advantages in helping to dissipate excess surface water by virtue of their rapid drainage properties.

Research in understanding the relationships between surface texture, skid-resistance and the acoustical properties of road surfaces have to some extent been confounded by several factors. Limiting the range of surface types within a study can bias results and the different ways skid-resistance is measured and used as an indicator of safety can produce conflicting results [17].

The sideways-force coefficient (*SFC*) is generally a low speed measure of surface friction using a wheel set at an angle to the direction of travel. Alternative measures of friction involving a locked-wheel allow the relationship between friction and speed to be examined over a much wider range of speeds. The braking force coefficient (*BFC*) is a general term often used to describe locked-wheel friction measurements. An important concern with skidding performance of a road surface is that as vehicle speeds increase the frictional



properties of the surface generally reduce and that the rate of loss in friction with speed is greater for lower-textured surfaces. Subsequently, skidding performance based on the relative change in friction with speed have provided additional measures for assessing safety performance over and above those based on absolute measures of friction. This plethora of methods for assessing skidding performance and how these different measures are influenced by texture amplitudes at different texture wavelengths may explain why the results of some research indicate a conflict between safety and low noise surfaces whereas others have found no link. Further insight to this problem may be sought by reviewing Figure 3.3.

The Figure shows that texture wavelengths important for skid-resistance cover a wide range of texture wavelengths from the lower microtexture range to the transition between the macro and megatexture regions. However, increasing texture amplitudes important for maintaining adequate skidding performance may have an ambivalent influence on tyre/road noise. Increasing texture amplitudes at wavelengths in the microtexture range will have little influence on tyre/road noise generation. In the macrotexture range, increasing texture amplitudes may reduce tyre/road noise by reducing the influence of aerodynamic mechanisms that generate noise. Increasing texture amplitudes at wavelengths close to the transition between the macro and megatexture regions may have a negative effect on noise by enhancing tyre vibrations to generate higher levels of tyre/road noise.

Clearly, from the above discussion, it is perhaps not so surprising that research linking safety and noise reduction has not provided a decisive outcome. However, it is equally clear that there is scope for designing road surfaces which have both adequate skidding performance and provide for low noise levels. The solution is to ensure that the texture amplitudes contributing to the desired safety requirements of the surface are at texture wavelengths which don't enhance tyre/road noise and preferably have a positive influence in reducing tyre/road noise.

### 3.3.2.2 Rolling resistance

Rolling resistance has a significant impact on both fuel economy and exhaust emissions, particularly CO<sub>2</sub>. Consequently, much research has been carried out to reduce rolling resistance, particularly by the tyre industry. Fortunately, it appears from the available research that tyre rolling resistance is not strongly correlated to tyre noise levels. In fact some research has shown that tyres with low rolling resistance also generate low noise levels [10]. Similarly, the influence of surface texture on rolling resistance does not conflict with the desire for low noise surfaces as can be seen from Figure 3.3. Reducing texture amplitudes at wavelengths important for low rolling resistance will tend to reduce noise generated by texture wavelengths associated with tyre vibration in the megatexture range.

In a paper by Descornet [31], it is shown that the maximum relative surface influence on rolling resistance is about 50% and that it can be converted into a 10% relative effect on fuel consumption. Moreover, megatexture is shown to be the major influencing factor, which suggests that both rolling noise and rolling resistance can be simultaneously reduced or kept at a minimum.

Within the SILVIA project, a limited study on rolling resistance has been performed [32] using a purpose-built trailer (see also Section A.5.2 of Appendix A). An international literature study on rolling resistance has also been carried out within the project [33].

### 3.3.2.3 Durability

Durability here is defined as the effect of ageing due to trafficking and weathering on the acoustic performance of a road surface. This process and its effect on acoustical performance is complex and dependent on a number of parameters including surface type, the porosity of the road surface, the degree of trafficking and exposure to weathering. Generally, the trend is for the acoustic performance of surfaces to stabilize after an initial period of 1 to 2 years of trafficking. Those surfaces which provide for low levels of tyre/road noise tend to increase in noise over this initial period, whereas surfaces which exhibit higher levels of tyre/road noise have shown some noise reductions [10].

This is in part confirmed by an experimental observation made in France on two techniques (with respect to passenger pass-by noise): Porous Asphalt 0/10, over a 10 year period, and Asphalt 0/6 class 2, over a 7 year period [34]. The analysis concluded the following:

- Porous Asphalt 0/10: Despite a rather heterogeneous behaviour of all the sections tested, a great part of them showed a noise level increase for cars, by +5.5 dB(A) between 1 and 10 years. It was noted that the noise levels on those sections with the lowest initial noise levels tended to increase over the time period, whereas those on the sections with the highest initial noise levels tended to remain stable during the first years;
- Asphalt 0/6 class 2: A rather regular increase in noise levels was observed: +3 dB(A) between 1 and 7 years.

Initially as the surface wears, texture amplitudes associated with the shorter wavelengths can be worn away by the action of traffic resulting in higher noise levels associated with the aerodynamic mechanism of tyre/road noise generation. To reduce this effect aggregate with high PSV (polished stone value) are sought which also have the benefits in retaining high skidding performance.

The effect of ageing can be particularly dramatic on the acoustic performance of some porous surfaces. Trafficking and weathering causes the voids in the surface to become clogged with detritus reducing acoustic absorption, resulting in increased noise levels. The use of de-clogging machines using water under high pressure to flush out the detritus has only been partially successful. Alternative designs using double-layer porous systems have proved to be more successful. The top porous layer consisting of small chippings acts as a filter, accumulating most of the detritus and leaving the lower larger aggregate size porous layer relative detritus-free. This design allows the cleaning process to be more efficient in retaining surface porosity than compared with single layer designs and can therefore extend the lifetime of its acoustic benefits.

However, after a period of stabilization some surfaces can exhibit significant increases in noise, particularly as the surface reaches the end of its life. Bituminous surfaces which exhibit surface fretting (loss of stone) after long periods of heavy trafficking, the appearance of cracks and the hardening of the bitumen due to long-term exposure can all contribute to higher levels of tyre/road noise. Concrete surfaces can also exhibit similar characteristics, for example, grooved concrete where after a period of heavy trafficking causes fraying of the grooves resulting in shallow/wider spacing which can promote higher noise levels [35].

The results from research highlighted above illustrates the importance that the acoustic performance of road surfaces should not only be assessed on their initial performance but over the whole life time of the surface.



## **PART 2: OVERVIEW OF EXISTING LOW-NOISE SURFACES**

### ***What solutions are currently available?***

*This Part of the Guidance Manual provides a brief review of existing low-noise surface types that are used in Europe. Details are provided for the material specifications and indicative values for the acoustic performance. The review considers surface properties that can be adjusted to improve acoustical performance such as aggregate size, thickness and porosity. Also included are details of recent experimental surfaces that may be successfully developed to a point where they are widely used. Such surfaces include poro-elastic and porous concrete surfaces. A further consideration is the optimisation of the structural durability of low-noise surfaces to improve cost effectiveness.*

*One issue is the choice of the term “low noise” surface which implies some absolute scale of effectiveness. In reality of course the surfaces are considered low noise because they produce lower noise readings when trafficked than a standard or reference surface. Different countries use different reference surfaces so it is possible a surface may be deemed low noise in one country and not in another. One way around the problem is to agree on an international reference surface such as the HARMONOISE reference (average of a Dense Asphalt Concrete (DAC) and Stone Mastic Asphalt (SMA) with maximum chipping size of 11 mm). Convergence to a national reference standard is, however, unlikely to occur in the immediate future as established procedures will need to be changed. Consequently, the reader is encouraged to judge the acoustical properties of different surfaces in terms of the absolute noise levels that have been determined to characterise these surfaces.*



## 4 Review of existing low-noise surfaces

This Chapter of the Guidance Manual provides a broad overview of existing low-noise pavement solutions that are used across Europe, including brief details on material specifications and typical figures for the acoustic performance.

### 4.1 Open graded and gap-graded asphalt surfaces

Open graded surfaces are defined as those where the aggregate specification results in a high void content. Gap graded surfaces are those where aggregate is graded without one or more intermediate sizes.

#### 4.1.1 Single-layer porous asphalt

##### 4.1.1.1 Definition, overview and background

Porous asphalt is designed to have a very high stone content (typically 81-85%) with a typical grading of 0/11, 0/16 or 0/20 with a gap at 2/7, which provides a high void content (usually > 20%). As a wearing course, the layer thickness is typically 40 mm. It can also be constructed as a two-layer pavement (see Section 6.1.1).

The first porous asphalt mixes evolved from experiments in the United States with plant mix seal coats in the 1930s. The purpose was first to provide enhanced performance relative to seal coats or chip seals on roads with high traffic volumes. In the early 1970s, many states began placing plant mix seals with the purpose to improve the overall frictional resistance of road surfaces and the term Open-Graded Friction Course (OGFC) was developed [36, 37]. OGFC was designed as an open mix with interconnecting voids that provided drainage during heavy rainfall. The rainwater drains vertically through OGFC to an impermeable, underlying layer and then laterally to the edge of the OGFC.

In Europe, porous asphalt was developed by TRL in the late 1950s for use on airport runways and trialled for use on public roads in the 1960s. The first pervious surface was laid on the M40 in the UK during 1967 [6]. Originally the surface was developed to reduce surface water and spray on high-speed roads during periods of heavy rainfall. However, following the road trials it was found that this type of surface also offered acoustic benefits. Subsequently, experiments with porous asphalt were carried out in many other countries in Europe and in other parts of the world. On highways in The Netherlands the use of single layer porous asphalt has become a standard surface. About 60% of the network is now single layer porous asphalt.

##### 4.1.1.2 Material specifications

A fundamental characteristic of porous asphalt surfaces is the high volume of open and inter-linked voids (up to 20-28% at the time of laying) which provide water circulation and the absorption of surface noise. The high percentage of voids is mainly due to the very high content of aggregates greater than 2 mm in size (83-87%). This essentially produces voids in the surface matrix as the gaps are not filled by the smaller particles. The volumes of mortar and mastic are therefore very small [38, 39]. Cohesion is therefore provided

almost exclusively by the binder, where the resistance to permanent deformation results from the friction and contact between the grains of stone and sand. The angularity of the mineral particles therefore plays a key role and there must be a good and permanent aggregate-binder bonding (adhesion) particularly in the presence of water.

There are two clearly distinct concepts used for this surface type:

- *The American concept:* This is referred to as an Open Graded Friction Course (OGFC), whereby the coated material is laid to a thickness of one inch (25 mm) with an aggregate size 0/10 mm (see footnote<sup>2</sup>) and discontinuity 2/7. The primary concern is tyre/road adhesion (resulting from a pronounced geometrical roughness of the surface) rather than drainability. The void content used in the USA is normally 12-16% [36, 37];
- *The European concept:* This is referred to as Porous Asphalt (PA) and generally has coated material laid to a thickness of 40-50 mm with an aggregate size of 0/14 mm and sometimes 0/20 mm (particularly in the UK). 0/10 compositions are usually considered as being optimal in France, 0/16 in The Netherlands. The grading is usually clearly discontinuous (2/7 or 2/10) except in the UK, where the split is not as clear cut but where the sand content is very low. The void content used is normally up to 20-24% but may sometimes be as high as 30% [38].

#### **Aggregate properties:**

The normal maximum aggregate size is 14 mm but 4, 8, 10, 16 and 20 mm sizes can also be used. The material is generally crushed. In the case of natural crushed gravel, the proportion of rounded and smooth sides must be very small. It is generally established that the aggregate must be characterized by a high Polished Stone Value (PSV). For example, in Belgium the requirement is a minimum PSV of 50 [39] and 53 in The Netherlands. In the Nordic countries where the use of studded tyres during the winter can cause additional damage to surfaces, there are also requirements regarding the maximum abrasion value for the aggregate [40].

The sand must be obtained by crushing hard rocks. In some countries the filler is the one which is naturally contained within the sand fraction but in other countries it is necessary to add manufactured filler, especially limestone and even cement. In many countries it is also required to add 1-2% of calcium hydroxide (slaked lime) to enhance the binder/aggregate adhesion. Figure 4.1 shows typical grading curves for dense asphalt, stone mastic asphalt and porous asphalt. The sizes above 2 mm are said to constitute the aggregate, the sizes below 2 mm constitute the mortar (where < 0.063 mm is the filler, 0.063 – 2 mm is the sand); The dense asphalt concrete is characterised by a continuous grading curve whereas porous asphalt has a gap-graded curve. The SMA is also gap-graded but with more fines < 2 mm.

---

<sup>2</sup> The maximum aggregate size is actually 3/8" (9.5 mm), although up to 5% by weight might be up to 1/2" (12.6 mm). The design thickness is actually 3/4" (19 mm). For example, see [www.fhwa.dot.gov/legsregs/directives/techadv/t.504031.htm](http://www.fhwa.dot.gov/legsregs/directives/techadv/t.504031.htm)



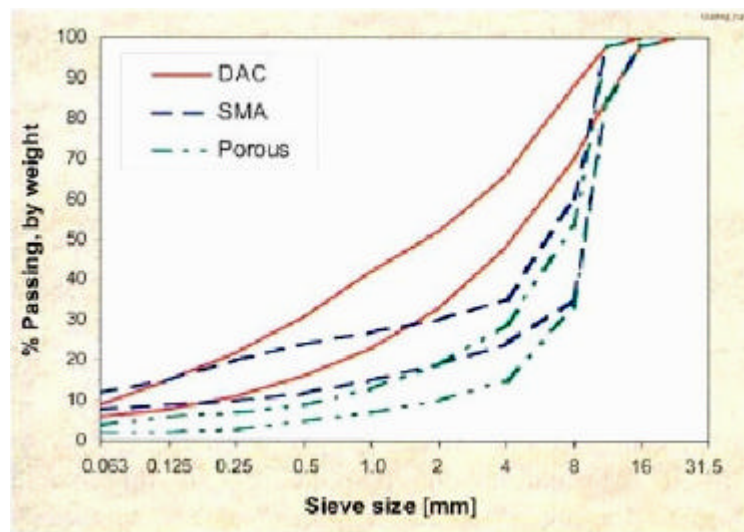

Figure 4.1: Comparisons between different grading curves (DAC/SMA/PA). The lines show upper and lower tolerances and refers to the Swedish standard VÄG 94 [10]

#### **Binder properties:**

With porous surfaces, the binder is more exposed to the atmosphere than with conventional dense asphaltic materials. This can lead to a more rapid aging of the binder and deterioration of the pavement under the action of trafficking. Ways of minimising the ageing include increasing the binder content so that the stones are covered with a thicker layer or using a binder formed from bitumen modified by the addition of polymers.

Increasing the binder content can, however, cause additional problems when constructing the surface. If the increase in binder content exceeds a certain level this can cause binder drainage and segregation during the manufacture, transport, laying and rolling processes. Moreover, increasing the binder content reduces the possibility of obtaining the high void content required for optimum noise reduction through sound absorption, as shown in the paper by Descornet [41]. The standard method for preventing binder drainage is to add various types of mineral or organic fibres, e.g. rock fibres and cellulose fibres, or a mix thereof. Asbestos, rubber and glass fibres have also been used, although the former is forbidden in several countries. The fibre content is generally between 0.3-0.4% of the total weight of aggregates.

Modified bitumens can generally be divided into two groups: those that are modified with new polymers (e.g. SBS, EVA, EPDM, SB, SBR, APP, PE) and those that are modified with recycled polymers. Modified bitumens are often factory produced but they can also be made on-site and even in the plant mixer [38]. Bitumens modified with recycled polymers are a mixture of 78-80% bitumen, 3% aromatic oil and 10-20% rubber powder from recycled used tires. The use of recycled rubber bitumen was introduced in the USA and has now also been used in different European countries.

It is especially important to ensure good adhesion in porous asphalt. One way of doing so is to add adhesion agents to the mix. In Sweden, for instance, an amine derivative or hydrated lime or cement is used for this purpose.

#### 4.1.1.3 Functional properties

The structure of porous asphalt differs from conventional dense asphalt mixes. It consists mainly of coarse aggregate and binder and a small proportion of sand and filler, thus creating an open texture and a permeable structure with extremely high porosity in excess of 20%. As a result of the high porosity, porous asphalt tends to provide a good standard of skidding resistance under both wet and dry conditions and its rapid drainage properties help to remove surface water, thereby reducing the incidence of spray and improving visibility during conditions of heavy rainfall.

#### 4.1.1.4 Advantages and disadvantages of the surface type

The following advantages and disadvantages are associated with porous asphalt (PAC):

##### **Advantages:**

Compared to normal dense asphalt concrete, PAC offers a significant noise reduction when the surface is in good condition. The acoustic performance tends to deteriorate if the pores become clogged with detritus.

The use of porous asphalt surfaces leads to a reduction in splash and spray, and aquaplaning since water is not accumulated on the road surface but drains away. This therefore results in improved visibility and reduced glare and improved skidding resistance in wet conditions.

##### **Disadvantages:**

There are problems with the durability of porous surfaces due to the more rapid aging of the binder. In addition, the skid resistance of PAC has been reported to be poorer than Dense Asphalt Concrete (DAC) under locked wheel braking; for example, it has been found that under heavy braking, stopping distances can be 20-40% longer than on DAC [39] due to the breakdown of the bitumen layer. This problem only exists in the first months after opening to traffic. During this period there is a thick bituminous layer around the aggregate at the surface of the asphalt layer. This bituminous layer wears off after a few months.

In a study by Phillips and Abbott [42], it was reported that noise levels on PAC in wet conditions increased by approximately 3.5 dB(A) relative to the same surface in dry conditions. At the same time, no increase in noise due to rain was observed on regular hot rolled asphalt (HRA). It is considered that this is due to the combined effect of the pores in the PA filling with water and the reduction in splash/spray and aquaplaning that occurs on porous surfaces leading to drivers reducing speed less than would be the case on dense surfaces. Furthermore, porous surfaces take longer to return to normal acoustic performance after rainfall than dense surfaces due to the different drying mechanisms (the passage of vehicle tyres for dense surfaces, evaporation for porous surfaces).

The pores of the surface tend to get clogged by dirt and detritus which has a tendency to spoil those properties that are dependent upon drainage and porosity. Although the passage of vehicle tyres will generate some degree of self-cleaning in the wheel tracks of high speed roads, these surfaces require periodic specialist cleaning to prevent clogging of the surface as a whole. It is recommended that the surfaces be cleaned approximately every two years.

There are problems with winter maintenance, since the porosity of the surface means that greater and more frequent salting is required than for dense surfaces since PA is more

prone to coverage by ice (due to moisture in the pores and the lower thermal conductivity of the surface).

Routine repairs of the surface, i.e. patching up, are also more difficult than for dense surfaces since such maintenance often impairs the essential drainage through the surface leading to reduced acoustic performance.

#### 4.1.1.5 Typical performance data

Table 4.1 summarises the acoustic performance data (based on SPB measurements – see Section A.1 of Appendix A for details on the measurement procedure) for single-layer PAC surfaces collated within the SILVIA project [43]. It should be noted that there was insufficient data from surfaces at a single site or of a similar aggregate size to allow for a detailed study of the typical acoustic lifetime for the surface type; however, based on the information available an attempt to give some information on acoustical lifetime performance is presented in Chapter 14. The data presented in the Table has been derived by averaging the data for all single-layer PAC surfaces, independent of aggregate size. Data on the age of the surfaces considered and the aggregate sizes used is also collated in the Table.

*Table 4.1: Summary of acoustic performance data for different single-layer PAC surfaces (See Section A.1 of Appendix A for details of the SPB method)*

Speed	No. of sites	Surface Age, yrs		SPB Level, dB(A)			Aggregate size, mm		
		Average	Range	Average	Min	Max	Average	Min	Max
<i>Passenger Cars</i>									
80 km/h	2	4.1	0.2 - 8.0	76.1	76.0	76.2	14.0	14.0	14.0
110 km/h	4	3.2	0.1 - 6.4	79.1	76.9	82.0	10.0	8.0	16.0
<i>Dual-axle heavy vehicles</i>									
85 km/h	4	3.2	0.1 - 6.4	82.1	79.4	83.8	10.0	8.0	16.0
<i>Multi-axle heavy vehicles</i>									
85 km/h	4	3.2	0.1 - 6.4	85.2	84.5	86.3	8.0	10.0	8.0 16.0

A comparison of the noise levels from the different surfaces described in this Chapter can be found in Section 4.3.

## 4.1.2 Thin layers

### 4.1.2.1 Definition, overview and background

Surface replacements and new pavement surfaces are now normally constructed with “thin layer” surfacings. They have replaced the more traditional surface dressings, which tend not to perform well under heavy traffic loading, and surfaces such as Hot Rolled Asphalt (HRA) surface courses that are susceptible to rutting and which, for safety reasons, may be difficult to maintain.

These “thin layers”/“thin surfacings” (TSF) or “thin wearing courses” (TWC) are almost always hot-mix materials that are laid typically to a thickness of between 20 mm and 40 mm. In the main they have been developed in Europe with Germany, France, Scandinavia, the Netherlands and Britain playing important roles in this development. They have been developed as a consequence of the need to provide sustainable, safe and durable surfacings under increasing traffic loading. Distinguishing features of most thin surfacings are the aggregate skeleton with relatively large voids that are filled with either bitumen mortar or mastic. The aggregate skeleton provides resistance to deformation and the bitumen mortar provides resistance to fatigue.

When and where the development of these thin surface course materials began is difficult to identify precisely, but is often attributed to work carried out in Germany in the 1960s where the first type of Stone Mastic Asphalt (SMA) was produced<sup>3</sup>. The performance of the material was such that even after studded tyres were banned in Germany (a principal factor in its development) its use was continued.

Thin surface technology developed significantly in France during the 1980s when several prototype surfaces were laid. A significant development from France was the successful trials of very thin surface layers i.e. Beton Bitumineux Tres Mince (BBTM) or the ultra thin layers (BBUM). These surfaces are more voided than the earlier materials developed in Germany and were found to provide good spray reduction and significant reduction in tyre-road noise.

In the past decade or so, much development work has been carried out in various countries which has resulted in a large variety of proprietary surface designs that follow the concept of thin surfacings. However, the amount of in-service data available to judge the performance may differ significantly for these systems, and a designer must carefully appraise candidate systems to ensure that the product selected is fit for purpose.

#### **4.1.2.2 Material specifications**

Typically, thin surfacings are proprietary materials and laid to thicknesses between 30 mm and 40 mm but of late, materials that can be laid to thicknesses down to 15 mm or less have been developed. A proposed classification of these very thin materials has been given by Sandberg and Ejsmont [10].

- Very thin surfacings (VTAC) typically have thicknesses between 20-30 mm;
- Ultra thin surfacings, thickness 12-18 mm;
- Micro surfacings, thickness 6-12 mm.

Another categorisation of thin surfacings has been given by Laws [44]:

- Thick slurry surfacing (cold mix);
- Multiple surface dressing;
- Paver-laid surface dressing (also known as ultra thin hot mixture asphalt layer (UTHMAL));

---

<sup>3</sup> Although SMA is a type of “thin surfacing” and is referred to in the part of the Manual, a more detailed description of SMA and its properties is given in the following section.

- Thin polymer-modified asphalt concrete;
- Thin Stone Mastic Asphalt

Note that the slurry surfacing and the multiple surface dressing are products slightly different to many of the thicker surface types normally grouped under the term “thin surfacings” as they do not have the same general aggregate structure.

Most of the thin surfacings are gap-graded materials and rely on aggregate interaction for stability and a relatively high proportion of bitumen-mortar in the voids for durability. The resulting mixture is usually impermeable to water and has good resistance to deformation and wear. Since the mixture is essentially rich in binder, there is the possibility of some binder draining occurring during the construction process. To prevent this, cellulose fibres and lately polymer-modified bitumens have been added to the mix.

To illustrate some of the features of thin surfaces, a selection of different designs are described in more detail below;

- There are two classes of VTAC (Very Thin Asphalt Concrete) thin surfacings. These are differentiated largely by void content. Class 1 surfacings have between 10% and 20% for gradings 0/6 and 0/10 and Class 2 have between 18% and 25% voids for VTAC 0/6 and VTAC 0/10 [45, 46];
- Slurry seals may be considered as a type of surface dressing, which consists of mineral aggregates, water, bitumen emulsion. Additives may also be present. Slurry seals can be placed in a single or double layer and compacted by rolling. Typically, the grading is 0/7 or 0/10 but may reduce to 0/4 where the traffic volume is low;
- Stone Mastic Asphalt (SMA) (see also next section) has a high stone content (70-80% > 2 mm) between which the voids are filled with a mortar saturated with bitumen. Often, the grading is 0/10 with a gap at 2/7;
- Gap-graded thin surfacings are normally laid between 20 mm and 30 mm thick and have a relatively high (plant coated) stone content (68-72%) and are hot rolled. Typically, the grading is 0/6 or 0/10. Cellulose fibres or elastomers are often added to the mix to give the binder more stability. The surface texture is relatively open though less so than porous asphalt and as voids are not interconnecting it does not function as a drainage layer;
- Open-textured thin surfacings are typically laid between 20 mm and 30 mm thick with a very high coated stone content of 81%-87%. Typically, the grading is 0/6 or 0/10. The binder is reinforced with elastomers and it provides a surface texture similar to porous asphalt.

#### 4.1.2.3 Functional properties

Although there may be different national priorities regarding the properties needed by these surfacings, common to all countries is the need to provide a durable and smooth surface profile resistant to rutting, skidding and water ingress.

Very thin surfaces with smaller chip sizes are often applied as low-cost surface improvements on roads carrying relatively low traffic. A European standard for this type of surface has been prepared by CEN (EN 13108-2) [46]. However, in France, a Technical Specification is already in place and in regular use [45].

A feature of thin surfacings is their noise reducing properties. This is partly attributable to the generally small aggregate size used which helps to reduce noise generated by the texture impact mechanism. In addition, the fact that the surface texture is provided by coated aggregates rather than by surface dressing with chippings also helps to produce lower tyre noise generation. Finally, the gap-graded nature (indented or negative texture) of most of the thin surfacings also gives them good air drainage properties that helps to reduce noise from air-pumping and other similar mechanisms of noise generation.

Some results of measurements that demonstrate the noise benefits of gap-graded thin surfacings are available in the literature, e.g. [48]. Research conducted in Finland evaluated the noise reducing properties of SMA<sup>4</sup> [48]. SMA5 (stone-mastic asphalt with 5 mm maximum aggregate size) was laid on four different roads in Helsinki. Results showed that for new pavement at 50 km/h a noise reduction of 3 dB (A) was obtained relative to the original pavement. At 80 km/h noise reduction was 7 dB(A). However the wear on the SMA5 was found to be much higher than the wear on coarser SMA pavements (6 times higher than SMA11 and 10 times higher than SMA16). Due to the wear, the noise on the SMA surfaces increased significantly after 1 year.

Apart from the lower noise properties of thin surfacings they also generally offer good drainage characteristics, which helps to produce relatively good spray reducing properties (as compared to conventional dense asphalt surfaces for instance).

#### **4.1.2.4 Advantages and disadvantages of the surface type**

As there are a range of in-service products that fall under the heading “thin surfacings”, it is not appropriate to be definitive regarding actual and perceived advantages and disadvantages that embrace all surface types. Notwithstanding, general points that apply to many of those surfacing systems are given below:

##### ***Advantages:***

Thin surfacings (especially Stone Mastic Asphalt when used as a thin surfacing) have a combination of good resistance to deformation and fatigue. This is made possible by the stone skeleton and relatively high percentage of mortar or binder, respectively.

Thin surfacings provide negative texture (indented texture) which tends to result in lower tyre noise generation than on more traditional materials.

In addition to generating less noise, the texture and configuration of the surface layer results in less spray than a more traditional surfacing material.

Due to the relatively thin layers that can be constructed with these materials, they can be laid quickly in suitable conditions covering large areas, thus minimising traffic disruption.

It has been shown that it is possible to recycle up to 70% of the materials used in thin surfaces.

---

<sup>4</sup> SMA here refers to SMA used as a thin surface, further information about SMA is given in section 4.1.3.

**Disadvantages:**

Due to the presence of thick binder films, skid resistance may be reduced during the first few months after being opened to traffic.

Due to the high skid-resistance characteristics required, thin surfacings normally use high PSV aggregate which is becoming less available, more expensive and often has to be hauled over long distances from source to site.

Depending on whether materials have bitumens modified by polymers, and the nature of the modifier, recycling can lead to additional health and safety risks.

**4.1.2.5 Typical performance data**

Table 4.2 (shown on the following pages) is included to illustrate the range of proprietary materials that can reduce road traffic noise and the typical noise reductions offered.

Table 4.3 summarises the acoustic performance data (based on SPB measurements – see Section A.1 of Appendix A for details on the measurement procedure) for thin layers surfaces collated within the SILVIA project [43]. It should be noted that there is insufficient data from surfaces at a single site or of a similar aggregate size to allow for a detailed study of the typical acoustic lifetime for the surface type; however, based on the information available an attempt to give some information on acoustical lifetime performance is presented in Chapter 14. The data presented in the Table has been derived by averaging the data for all thin surfacings, independent of aggregate size, to determine a mean performance over the surfaces available. Data on the age of the surfaces considered and the aggregate sizes used is also collated in the table.

Table 4.2: Example of proprietary low-noise thin layers

Surface Description	Light vehicles		Heavy vehicles		Traffic / other		Reference surface (Type & Country)
	Noise reduction (dB)	Ref speed (km/h)	Noise reduction (dB)	Ref speed (km/h)	Noise reduction (dB)	Fleet & speed information	
<b>Axofibre</b> , 14 mm aggregate SMA	$L_{Amax} = 3-4$	90 & 110					BCC (UK)
<b>Masterpave</b> , 35 mm thick, 14 mm gritstone SMA	$L_{Amax} = 3.8$	110	$L_{Amax} = 3.7$	90			HRA (UK)
<b>Tuffgrip</b>	$L_{Amax} = 3.8$ $L_{Amax} = 4.6$	90 110	$L_{Amax} = 3.2$	90			HRA (UK) after 5 weeks
<b>Safepave</b> thin wearing course, 10 mm aggregate, UTHMAL	$L_{Amax} = 2.2$	90	$L_{Amax} = 0$	90			HRA (UK)
<b>Safepave</b> thin wearing course, 14 mm aggregate, UTHMAL	$L_{Amax} = 3.0$	90	$L_{Amax} = 1.7-2.5$	90			BCC (UK)
<b>UL-M</b> , 10 mm VTSL, 20 mm thick	$L_{Amax} = 4.4-5.3$	90	$L_{Amax} = 1.7-3.8$	90			BCC (UK)
<b>Novachip</b>	$L_{Amax} = 1.3$	70					DAC (NL)
<b>Megapave</b> , 25 mm thick, 10 mm granite with bituminous binder and 4% voids					$L_{A10} = 2.6$ $L_{A10} = 3.8$	774 veh/hr, 9.3% HGV @ 65 km/hr 706 veh/hr, 8.7% HGV at 65 km/h	HRA (UK) HRA (UK)

BCC: Brushed Cement Concrete; DAC: Dense Asphalt Concrete; HRA: Hot Rolled Asphalt  
UK data in this table is reproduced from [50]



Table 4.2: Example of proprietary low-noise thin layers (continued)

Surface Description	Light vehicles		Heavy vehicles		Traffic / other		Reference surface (Type & Country)
	Noise reduction (dB)	Ref speed (km/h)	Noise reduction (dB)	Ref speed (km/h)	Noise reduction (dB)	Fleet & speed information	
Accoduit	$L_{Amax} = 0.3$	50					DAC (NL)
Bruitville	$L_{Amax} = 3.6$	50					DAC (NL)
Decipave	$L_{Amax} = 4.3$	50					DAC (NL)
Dubofalt	$L_{Amax} = 5.3$	50					DAC (NL)
Fluisterfalt	$L_{Amax} = 4.1$	50					DAC (NL)
Microflex 0/6	$L_{Amax} = 4.0$	50					DAC (NL)
Micropave	$L_{Amax} = 3.8$	50					DAC (NL)
Micro-Top 0/6	$L_{Amax} = 4.3$	50					DAC (NL)
Micro-Top 0/8	$L_{Amax} = 2.0$	50					DAC (NL)
Microville	$L_{Amax} = 3.7$	50					DAC (NL)
Nobelpave	$L_{Amax} = 4.6$	50					DAC (NL)
Redufalt	$L_{Amax} = 3.4$	50					DAC (NL)
Stil Mastiek	$L_{Amax} = 4.4$	50					DAC (NL)
Tapisville	$L_{Amax} = 3.4$	50					DAC (NL)
Viagrip	$L_{Amax} = 3.6$	50					DAC (NL)
ZSA-SD	$L_{Amax} = 4.6$	50					DAC (NL)
ZSM	$L_{Amax} = 4.0$	50					DAC (NL)

BCC: Brushed Cement Concrete; DAC: Dense Asphalt Concrete; HRA: Hot Rolled Asphalt  
 UK data in this table is reproduced from [50]

Table 4.2: Example of proprietary low-noise thin layers (continued)

Surface Description	Light vehicles		Heavy vehicles		Traffic / other		Reference surface (Type & Country)
	Noise reduction (dB)	Ref speed (km/h)	Noise reduction (dB)	Ref speed (km/h)	Noise reduction (dB)	Fleet & speed information	
<b>Hitex</b> , thin polymer-modified asphalt					$L_{A10} = 2.7$	Speed not specified	HRA (UK)
<b>Safepave</b> thin wearing course, 14 mm aggregate, 10-25 mm thick, UTHMAL					40% reduction	Speed not specified	BCC (UK)
<b>Smartex</b> range, 10-50 mm thickness, 6-20 mm aggregate SMA					$L_{A10} = 3-4$	Speed not specified	HRA (UK)
<b>Thinpave</b> , thin polymer modified asphalt					$L_{A10} = 4$	Speed not specified	HRA (UK)

BCC: Brushed Cement Concrete; DAC: Dense Asphalt Concrete; HRA: Hot Rolled Asphalt  
 UK data in this table is reproduced from [50]

A comparison of the noise levels from the different surfaces described in this Chapter can be found in Section 4.3.

Table 4.3: Summary of acoustic performance data for different thin layer surfaces

Speed	No. of sites	Surface Age, yrs		SPB Level, dB(A)			Aggregate size, mm		
		Average	Range	Average	Min	Max	Average	Min	Max
<i>Passenger Cars</i>									
50 km/h	6	0.5	0 - 2.0	65.8	61.5	68.9	6.0	6.0	6.0
80 km/h	2	0.5	0 - 1.0	72.4	70.3	74.4	6.0	6.0	6.0
110 km/h	7	3.3*	0.3 - 4.9*	82.3	79.4	85.7	8.0	8.0	8.0
<i>Dual-axle heavy vehicles</i>									
50 km/h	3	1.0	0.5 – 2.0	77.1	75.5	78.7	6.0	6.0	6.0
85 km/h	7	-----	Unknown -----	84.2	81.8	86.3	8.0	8.0	8.0
<i>Multi-axle heavy vehicles</i>									
85 km/h	7	0.3**	---**	85.8	82.9	88.0	8.0	8.0	8.0

\* Age data only available for four of the seven surfaces in the analysis

\*\* Age data only available for one of the seven surfaces in the analysis

### 4.1.3 Stone mastic asphalt (SMA)

#### 4.1.3.1 Definition, overview and background

Although Stone Mastic Asphalt (SMA) is often regarded as a thin surfacing and has therefore been mentioned as a subclass of this surface type in the previous section, it is also better known as an important subclass of the range of dense asphalt concrete (DAC) surface types. However, it does have advantages over DAC in terms of noise generation as it also exhibits some of the properties of an open textured porous concrete.

SMA is essentially a bituminous material that is characterised by its large proportion of coarse aggregate that interlocks to form a stone-to-stone skeleton. In the USA, SMA is referred to as stone matrix asphalt. The stone skeleton is filled with a mastic of bitumen, filler, sand and a binder drainage inhibitor (usually fibres). The role of the stone skeleton is to carry load and create high resistance to permanent deformation, whereas the role of the mastic is to provide durability and a long service life of the pavement. With good interlocking, aggregates deform much less than asphalt binder under load and this significantly reduces rutting. The major SMA types used include 0/5, 0/6, 0/8, 0/10, 0/11, 0/14 and 0/16. The latter is used to withstand heavy loading and to give resistance to studded tires where used.

Typical SMA consists of 70-85% coarse aggregate, 5-14% filler, 5-8% bitumen and by 0.3-0.4% fibres. The void content is usually between 1.5-8% by volume (see prEN 13108-5 [51]). These wide ranges signify that there is no universal SMA or approach to the

design of SMA mixes, but several have been adapted for local conditions and requirements.

SMA is generally more expensive than a typical dense-graded asphalt concrete because it requires more durable aggregates, higher asphalt content, modified asphalt binder and fibres. However, in the right situations it is cost-effective because of its increased resistance to rutting and improved durability.

#### 4.1.3.2 Material specifications

To achieve the optimum performance of SMA or any asphalt mixture, it has to be properly designed, manufactured and constructed. This is especially true for SMA due to its high sensitivity to variations in constituent material proportions. A universal SMA mix or design approach does not exist, but a range of SMA designs have been adapted for local conditions and requirements. They do, however, have one thing in common, which is that they all include optimisation of proportion of mastic and coarse aggregates.

The design process includes five steps:

- Selection of proper constituent materials (e.g., a hard, cubical, and coarse aggregate with a carefully controlled gradation and sufficient PSV value, appropriate bitumen with the right properties to resist both rutting and thermal cracking and an appropriate type of filler);
- Identifying aggregate gradation to ensure a stone-to-stone skeleton;
- Evaluation to determine that sufficient VMA (Voids in Mineral Aggregate) is achieved;
- Selection of bitumen content that provides the target air void level;
- Evaluation of the mixture sensitivity to moisture and binder drainage.

The production and construction of SMA mixtures require great attention to detail; aggregates need to be carefully stockpiled to minimise variability and segregation, mineral fillers also require special storage and handling to properly meter them into the mixture. The mixing temperature at the plant is generally typical for conventional asphalt mixtures or slightly higher to ensure a suitable viscosity of the mastic.

The essential characteristics of SMA are the volumetric parameters: the quality of the mixture is essentially determined by the right volumetric proportion of the constituent materials and the right distribution of skeleton voids (VCA) and mastic portions. Given data on traffic and climate conditions, construction operations and economical considerations, the selection of constituent materials should be optimised.

Modified binder and fibre (e.g., mineral or cellulose) may be used to improve adhesion and stability. Mineral fillers and additives are used to minimise asphalt binder drainage during construction to increase the amount of asphalt binder used in the mixture and to improve mix durability. A ratio of between 1:2 and 1:3 is recommended [52] for the number of flat and elongated particles in the coarse aggregate.

**Binder properties:**

The binder used in SMA mixtures should be the same as used in high-volume roads, i.e., high-performance bitumen for high and low temperatures but, if applicable, with an enhanced grade for high traffic volume and slow-moving traffic. In most instances, this will result in the use of a binder with polymer modification. The selection of mineral fillers and fibres is crucial in the formation of the mastic in the mixture and both mineral and cellulose fibres have been used successfully in SMA.

The binder used for SMA is either paving grade bitumen or modified bitumen and the binder content should be as high as possible. Due to the high bitumen content a drainage inhibitor may be needed to prevent binder drainage during construction. Most commonly bitumen drainage is prevented by addition of either polymer modifiers or cellulose fibre. It is also very important to evaluate the potential for binder drainage during the mix design process. The mixture should have a total drainage of less than 0.3% at the production temperature. SMA is generally designed to be virtually impermeable and has very good resistance to deformation by virtue of its stone-to-stone skeleton. The level of texture depth achieved is largely a function of the material design.

However, the thicker bitumen films on the aggregate take longer time to be worn off by the traffic. Thus, when the SMA mixes are new, they might have a rather thick bitumen film on the surface that might limit early life skid resistance and cause “bituplaning” (see Figure 4.2). Gritting with crushed sand can improve the initial skid resistance.



Figure 4.2: Bitumen coverage of aggregate at initial stage

**Aggregate properties:**

In general the aggregate in the SMA should be of high quality and selected for the traffic conditions, with appropriate texture to provide good skid resistance. As SMA performance is very dependent on developing and maintaining the aggregate skeleton, high quality aggregate and tight gradation control are critical. The performance of SMA relies on stone-to-stone contact between very hard, cubical aggregates to obtain structural strength. Crushed aggregates are recommended for both the coarse and fine mineral fractions.

Particular qualities of SMA can be appreciated by appraisal of texture volumetry. A comparison of aggregate grading of typical SMA and Asphalt Concrete (AC) is indicated in Figure 4.3, where the large proportion of coarse aggregate is clearly shown. The texture of the SMA and AC is shown in Figure 4.4.

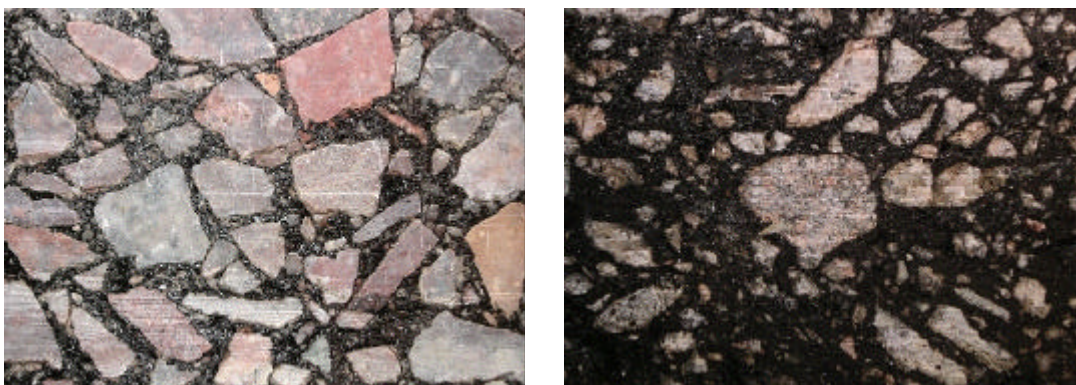

Figure 4.3: Comparison of aggregate grading for SMA (gap-graded) and AC (dense graded)



Figure 4.4: Comparison of surface texture of SMA and AC

#### 4.1.3.3 Functional properties

The principal difference between an SMA and continuously graded asphalt concrete mixtures (continuously graded) is that the gap in the grading curve is more pronounced, resulting in significantly more voids in the aggregate structure. From the volumetric point of view SMA is similar to porous asphalt which also consists of a gap-graded aggregate structure mainly comprising coarse aggregate.

#### 4.1.3.4 Advantages and disadvantages of the surface type

When properly designed, produced and laid, SMA provides excellent riding characteristics (evenness, smoothness, skid resistance), high resistance to permanent deformation and cracking, as well as reduced spray and noise. When compared to normal dense-graded AC, SMA may reduce road noise by up to 3 dB(A) under favourable conditions (optimised texture and small maximum aggregate size). Tight quality control in mix design, aggregate quantities, mixing and construction is required.

On site, it is imperative that good construction practices be followed. The paver should operate continuously and smoothly, which can best be accomplished by balancing the production rate to the paver. Care should be taken to minimise segregation and the occurrence of cold spots in the mat. Rolling should occur immediately behind the paver,

and compaction should be achieved very quickly before the mat has cooled. It is recommended that the in-place density be 94-98% of maximum density. Reduced skid-resistance can occur initially after laying.

#### 4.1.3.5 Typical performance data

Table 4.4 summarises the acoustic performance data (based on SPB measurements – see Section A.1 of Appendix A for details on the measurement procedure) for SMA surfaces collated within the SILVIA project [43]. It should be noted that there is insufficient data from surfaces at a single site or of a similar aggregate size to allow for a detailed study of the typical acoustic lifetime for the surface type; however, based on the information available an attempt to give some information on acoustical lifetime performance is presented in Chapter 14. The data presented in the Table has been derived by averaging the data for all SMA surfaces, independent of aggregate size, to determine a mean performance over the surfaces available. Data on the age of the surfaces considered and the aggregate sizes used is also collated in the table.

Table 4.4: Summary of acoustic performance data for different SMA surfaces

Speed	No. of sites	Surface Age, yrs		SPB Level, dB(A)			Aggregate size, mm		
		Average	Range	Average	Min	Max	Average	Min	Max
<i>Passenger Cars</i>									
50 km/h	6	1.4	0.2 - 2.0	70.6	68.6	74.1	8.6	6.0	12.8
80 km/h	5	3.5	0.2 - 8.0	78.7	76.5	82.1	12.8	10.0	16.0
110 km/h	11	3.2	0.2 - 7.8	82.2	78.3	86.1	10.1	8.0	16.0
<i>Dual-axle heavy vehicles</i>									
50 km/h	6	1.4	0.3 - 3.0	79.1	77.3	85.3	8.6	6.0	12.8
70 km/h	1	1.0	---	81.9	---	---	16.0	---	---
85 km/h	10	2.8	0.2 - 7.8	85.2	82.9	87.0	10.1	8.0	16.0
<i>Multi-axle heavy vehicles</i>									
50 km/h	3	1.8	0.3 - 3.0	81.6	79.6	83.3	9.9	6.0	12.8
70 km/h	1	1.0	---	86.8	---	---	16.0	---	---
85 km/h	11	3.2	0.2 - 7.8	88.3	84.2	91.0	10.1	8.0	16.0

Poor performance or problems during construction are typically due to the amount of air voids in the mixture. Observed problems are fully or partly connected to the mixture air-voids.



## 4.2 Cement concrete surface treatments

While roads surfaced with asphaltic materials acquire their surface texture by virtue of the aggregates or chippings provided in the material, roads surfaced with concrete normally require additional processes to impart texture to the surface. A range of techniques have been developed to accomplish this. As with asphaltic surfaces, it is important to have a full understanding of the relationships between the texture required to achieve adequate skid resistance under wet conditions for a high level of vehicle safety, as well as minimizing the tyre/road noise level. Several studies that attempt to optimise the texture imparted to concrete road surfaces have been undertaken [53, 54].

In describing the methods that are available for texturing concrete roads, a distinction has to be made here between surface textures produced in fresh concrete, and those produced on hardened (generally older) concrete by means of grinding or application of a new surface. The effectiveness of a concrete surfacing is dependent on the properties of the aggregates used in the concrete such as shape, size, strength and durability, and the method of surface finishing.

### 4.2.1 Exposed aggregate cement concrete

#### 4.2.1.1 Definition, overview and background

Exposed aggregate cement concrete is defined as being a surface where the surface mortar of the concrete is removed before the surface hardens, thereby exposing the aggregate. Figure 4.5 shows a typical exposed aggregate cement concrete surface.



Figure 4.5: Example of an exposed aggregate cement concrete surface

The process includes spraying the finished (but still fresh) surface with a setting retarder (essentially sugar) and covering the surface with a plastic sheet to prevent evaporation.



From 12-16 hours after paving, any required transverse contraction joints or longitudinal joints can be sawn in the retarded surface. After a period of time, depending upon the ambient conditions, the plastic sheet is removed and the retarded mortar is brushed away exposing the coarse aggregate. The brushing operation has to be undertaken from 24 to 72 hours after paving, depending on the retarder used and the ambient conditions. The timing of this operation is crucial; brushing too early will result in a loss of coarse aggregate from the surfacing; conversely, the mortar will not be removed if the brushing is too late, resulting in the coarse aggregate not being exposed. A technique to determine when to brush the surfacing was developed in the UK [55]) based on the maturity of the concrete. As a result of a laboratory study it was proposed that brushing could commence from a maturity of sixteen hours curing at 20°C. A similar study could be undertaken using the concrete mixture and retarder for specific contracts to determine the range of maturity for which brushing was effective. This may allow a second brushing of the surface if the required texture was not achieved initially. If the brushing is carried out within 48 hours of paving, the surface should be protected by spraying a curing compound to finish the surface. An example of a brushing machine is shown in Figure 4.6. This activity can be postponed up to 72 hours after paving depending upon the weather conditions and the retarder.



Figure 4.6: Example of a brushing machine

The initial purpose for developing this technique was to achieve a high skidding resistance. Further investigations on EACC have shown a significant noise reduction potential in comparison to other standard surface finishes of cement concrete pavements and some asphalt surfaces.

#### 4.2.1.2 Material/surface specifications

Gap graded cement concrete mixes have been identified as being preferable for optimising the noise performance of the surface. Two fractions of aggregates are used for optimised EACC based on Dutch studies: the average particle size of the fine aggregate is approximately 15% of that of the coarse aggregate. Where possible, both particle sizes

should consist of uniformly shaped particles. The aim is to compact the coarse aggregate as much as possible.

It is important that the surface provides optimum macrotexture and low megatexture levels. Low megatexture can be obtained by using

- A longitudinal “super-smoother” vibrating plate, as shown in Figure 4.7 or smoothing beam rather than a transverse beam (before exposing the aggregate);
- As small a maximum aggregate size as possible.



Figure 4.7: Example of a longitudinal “super-smoother”

The aggregate to be exposed should preferably have grain sizes of 4-8 mm in order to provide the optimum macrotexture. To achieve a high skidding resistance, the aggregates should have a high Polished Stone Value of at least 53 (preferably 55).

#### 4.2.1.3 Functional properties

Exposed aggregate cement concrete can be constructed as either a single- or double-layer surface. In Austria, double-layer construction is the preferred method. In order to minimise costs, the expensive polishing and wear-resistant aggregates are only used in the upper layer. The bottom layer can be constructed from normal road construction concrete. The bottom layer can be constructed from locally available (and cheaper) aggregates, but the use of recycled concrete material is also possible [56].

In order to minimise the noise level, the maximum aggregate size for the upper layer has been reduced to 8 mm, while the common maximum aggregate size in the bottom layer is 32 mm. This may lead to a reduction of the noise level of about 2 dB(A) when compared with conventional concrete pavements. The use of an 11 mm maximum chipping size will enhance the skidding resistance of EACC surfaces; the resulting small increase in noise level is acceptable.

***Air content:***

To ensure frost resistance of the concrete, it is desirable to incorporate an air entraining agent in the mixture. The air bubbles act as an expansion vessel for freezing water contained in the capillaries between the air bubbles. Furthermore, the introduced air bubbles are also necessary for workability. In addition to the requirement for a Water Cement Factor (WCF) lower than 0.45, the desired maximum air content depends on the maximum particle size of the coarse aggregate as follows:

- Maximum particle size 14 mm: Air content of < 4%
- Maximum particle size 8 mm: Air content of < 5%

***Exposure of the concrete:***

Either a normal retarder or a combined retarder and curing compound can be used. The brushing/exposure of the aggregate has a significant influence on the final result with respect to noise emission. Exposure is carried out running in the direction of the carriageway with either a nylon or steel brush which influences the exposure depth. Structural considerations require that the maximum depth be 30% of the smallest particle size of the coarsest fraction. If the exposure is deeper than 30% then the adhesion of the coarse aggregate in the concrete may be threatened. It is recommended to clean the concrete surface with a sweeper immediately following the brushing/exposing.

**4.2.1.4 Advantages and disadvantages of the surface type**

When the surface is laid correctly, optimised EACC can be almost as quiet as noise optimised stone mastic asphalt or thin layer solutions [57], as shown in Figure 4.9, whilst easily meeting other comfort and safety requirements such as those related to evenness and skidding resistance. EACC can be characterised by a high and lasting skidding resistance potential. A significant advantage of EACC in comparison to other low-noise surfaces can be found in the considerable durability of 20 to 30 years, and having roughly the same noise reduction potential over the lifetime (see Figure 4.8).

With regards to winter maintenance, no specific problems have been observed; there are no additional salt requirements compared to those for standard cement concrete pavements.

The techniques for laying EACC are not easily applied and require good quality, and therefore expensive aggregate, to be used in the full depth of the layer even though they are only required on the top of the surface. Departing from sufficiently good grading for strength performance can make it more difficult to meet the necessary structural requirements. These drawbacks can be overcome by laying EACC as a double layer surface where the underlying layer is designed to provide sufficient structural performance and the upper layer is optimised for texture performance.

**4.2.1.5 Typical performance data**

Table 4.5 summarises the acoustic performance data (based on SPB measurements – see Section A.1 of Appendix A for details on the measurement procedure) for EACC surfaces collated within the SILVIA project [43]. It should be noted that there is insufficient data from surfaces at a single site to allow for a detailed study of the typical acoustic lifetime for the surface type; however, based on the information available an attempt to give some information on acoustical lifetime performance is presented in Chapter 14. The data presented in the Table has been derived by averaging the data for all EACC surfaces

to determine a mean performance over the surfaces available. Data on the age of the surfaces considered and the aggregate sizes used is also collated in the table.

Table 4.5: Summary of acoustic performance for exposed aggregate cement concrete (EACC) surfaces

Speed	No. of sites	Surface Age, yrs		SPB Level, dB(A)			Aggregate size, mm		
		Average	Range	Average	Min	Max	Average	Min	Max
<i>Passenger Cars</i>									
80 km/h	2	4.1	0.2 - 8.0	75.6	74.5	76.8	7.0	7.0	7.0
110 km/h	6	5.4	0.2 - 10.2	83.9	80.9	85.8	10.0	10.0	10.0
<i>Dual-axle heavy vehicles</i>									
85 km/h	6	5.4	0.2 - 10.2	85.6	83.0	86.6	10.0	10.0	10.0
<i>Multi-axle heavy vehicles</i>									
85 km/h	6	5.4	0.2 - 10.2	87.4	85.1	88.4	10.0	10.0	10.0

As part of an extensive CPX measurement programme undertaken in Austria, analysis has been carried out of the rolling noise performance of EACC surfaces laid on Austrian motorways [57]. Details of the CPX method are included in Appendix A. Figure 4.8 shows the CPX Index on a newly laid pavement (0-2 years old) for several speed conditions compared to that for a DAC11 reference surface and also how the noise reduction performance of the surface reduces with age relative to that when the surface is new. Figure 4.9 shows the performance of EACC surfaces in comparison to other surface types.

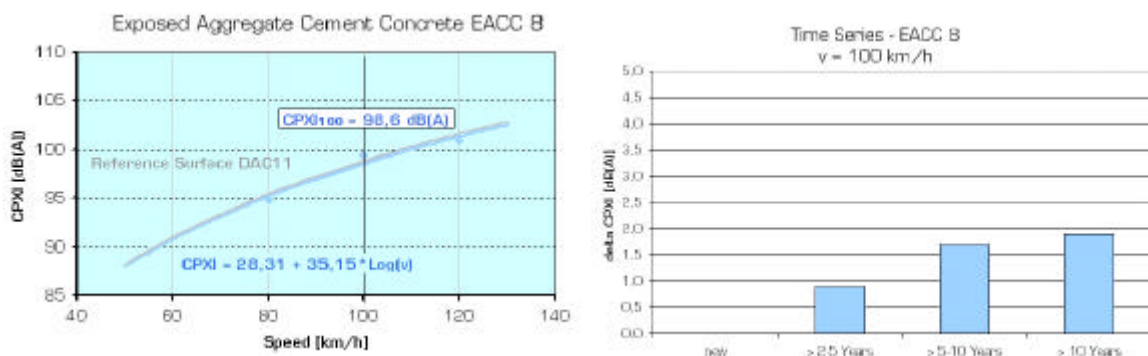

Figure 4.8: Rolling noise levels of EACC 8 on Austrian motorways [57]

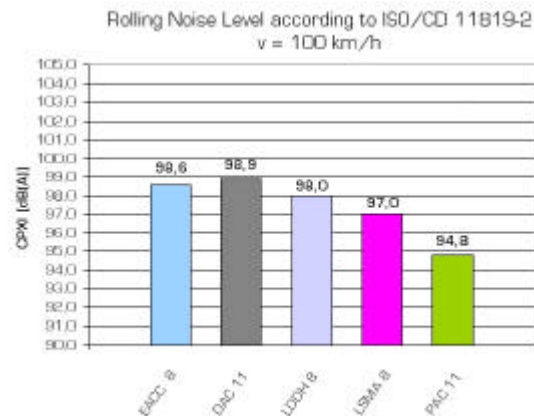

Figure 4.9: Noise reducing potential of EACC 8 on Austrian motorways compared to other surface types [57]

Based on the results of SPB measurements at nine Dutch test sections, the noise reduction for optimised exposed aggregate concrete with a fine (4/7) gap-graded mix was calculated. Table 4.6 shows the reduction in vehicle noise,  $?_{road,m,v_{ref}}$  dB for different vehicle categories ( $m$ ), light and heavy, at different reference speeds,  $v_{ref}$  km/h compared with corresponding noise levels for dense asphaltic concrete (DAC) with 0/16 maximum size aggregate.

Table 4.6: Noise reduction for optimised exposed aggregate concrete (4/7)<sup>1</sup>

Vehicle category	Reduction in vehicle noise, $?_{road,m,v_{ref}}$ , for different vehicle categories, $m$ at the nominated reference speed, $v_{ref}$ km/h				
	50	60	70	80	90
M					
Light	0.4	0.2	0.0	-0.1	-0.2
Heavy	-	-	-1.9	-2.2	-

<sup>1</sup> Negative values mean a reduction of the noise emissions compared to DAC 0/16.

## 4.2.2 Burlap textured cement concrete (Longitudinally structured)

### 4.2.2.1 Definition, overview and background

Concrete surface can be textured when the concrete is newly laid by dragging burlap sacking across the surface in a longitudinal direction.

To achieve the necessary optimised surface characteristics it is necessary to produce the road surface as a two-layer concrete pavement. The texture is applied between smoothing the fresh concrete surface and spraying the adapted curing agent. An example of this is shown in Figure 4.10.





Figure 4.10: Longitudinal structuring of cement concrete with burlap

#### 4.2.2.2 Material/surface specifications

The most important specifications for the burlap used to generate the texture are:

- A surface weight of at least 300 g/m<sup>2</sup>.
- A concrete contact length of at least 2 m.
- A finger length of approx. 3 cm. (Need to define finger length)

Before first usage, the burlap should be moistened slightly. The burlap should also be replaced or washed on a regular basis, preferably at least once every workday, so as to enable uniform texturing of the concrete.

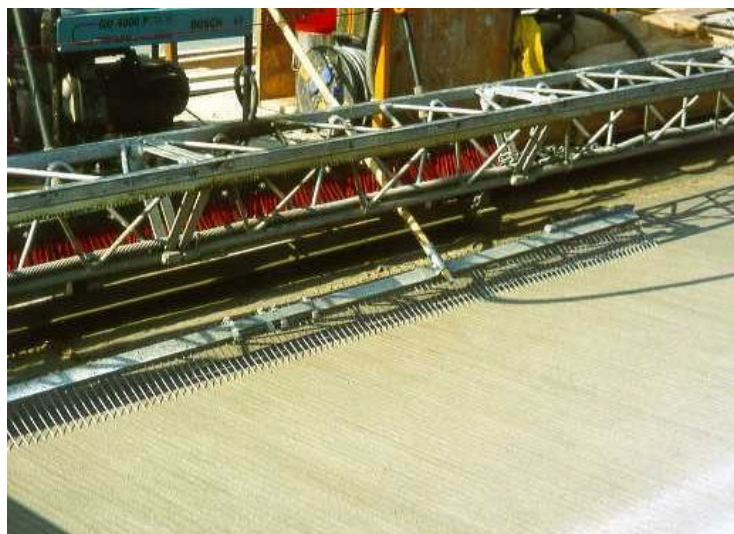

Figure 4.11: Longitudinal structuring of cement concrete with burlap and a comb

In order to increase the macrotexture component of the surface to improve drainage and ventilation between tyres and pavements, a combined application of burlap and steel comb can be advantageous, as shown in Figure 4.11. The steel comb consists of individual spring-steel tines 130 mm in length and spaced at 15 mm. This comb spans the entire carriageway width and is positioned behind the burlap and drawn over the concrete surface at a tilt angle of approximately 30°. Clumps of mortar may form on the spring-steel tines so the comb needs to be cleaned to achieve uniform structuring.

#### 4.2.2.3 Functional properties

The durability, consistency and thickness of the surface mortar have a particular influence on the final texture of the finished surface. The near-surface concrete should use fine aggregates with a high resistance to polishing and have a low water/cement ratio. The effect of using uniform fine aggregates with a chipping size of 0.71-1.0mm is very favourable. A polish stone value  $\geq 0.55$  is used. If the durability of the texture is insufficient, then within a few years the surface mortar will be removed by traffic and weather conditions. Subsequently the crushed coarse chippings are also stressed directly. These aggregates should also be highly resistant to polishing.

#### 4.2.2.4 Advantages and disadvantages of the surface type

Burlap textured cement concrete has a relatively poor skid resistance compared to other surface finishes and therefore may not be suitable for high speed roads.

#### 4.2.2.5 Typical performance data

Table 4.7 summarises the acoustic performance data (based on SPB measurements – see Section A.1 of Appendix A for details on the measurement procedure) for burlap textured concrete surfaces collated within the SILVIA project [43].

Table 4.7: Summary of performance data from concrete surfaces including burlap textured cement concrete (Data marked \* denotes Burlap textured surfaces only)

Speed	No. of sites	Surface Age, yrs		SPB Level, dB(A)			Aggregate size, mm		
		Average	Range	Average	Min	Max	Average	Min	Max
<i>Passenger Cars</i>									
50 km/h	2	1.5	1.0 - 2.0	75.6	74.0	77.2	-----	Unknown	-----
110 km/h*	10	8.1	2.8 - 13.3	84.6	79.8	90.7	2.0	2.0	2.0
<i>Dual-axle heavy vehicles</i>									
50 km/h	2	1.5	1.0 - 2.0	83.0	78.9	87.1	-----	Unknown	-----
85 km/h	9	7.6 <sup>†</sup>	2.8 - 13.3 <sup>†</sup>	87.4	80.6	91.4	2.0	2.0	2.0
<i>Multi-axle heavy vehicles</i>									
50 km/h	2	1.5	1.0 - 2.0	82.2	79.6	84.7	-----	Unknown	-----
85 km/h	10	7.5 <sup>‡</sup>	2.8 - 13.3 <sup>‡</sup>	90.1	84.6	94.2	2.0	2.0	2.0

\* Data for burlap textured surfaces only

<sup>†</sup> Age data only available for six of the nine surfaces in the analysis

<sup>‡</sup> Age data only available for seven of the ten surfaces in the analysis

It should be noted that there is insufficient data from surfaces at a single site to allow for a detailed study of the typical acoustic lifetime for the surface type; however, based on the information available an attempt to give some information on acoustical lifetime performance is presented in Chapter 14. The data presented in the Table has been derived by averaging the data for all burlap textured surfaces to determine a mean performance over the surfaces available. Data on the age of the surfaces considered and the aggregate sizes used is also collated in the table.

### 4.2.3 Diamond-ground concrete (Longitudinally structured)

Diamond-ground concrete surfaces are achieved by planing the concrete surface using a set of closely-spaced diamond discs which form thin (typically 3 mm wide), parallel, longitudinal grooves. The close spacing removes ridges and other features which result in unevenness of cement concrete surfaces. Figure 4.12 shows an example of a typical diamond-ground cement concrete surface.

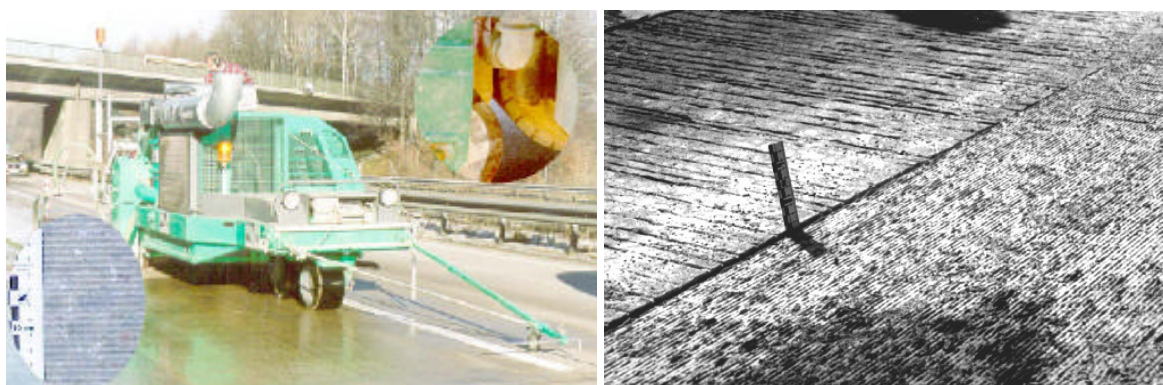

Figure 4.12: Example of a grinding machine and a typical longitudinal diamond-ground cement concrete surface

The technique has been used for many years in the USA but only occasionally in European countries, e.g. Belgium where it has been applied specifically to reduce road traffic noise.

Unlike longitudinal-grooved concrete surfaces this type of grooving does not induce “shimmy” in the steering of vehicles travelling on the surface which could be hazardous to motorists.

A key disadvantage is the high cost of this type of treatment. The surface is also susceptible to wear from studded tyres.

### 4.2.4 Epoxy-bound surface dressings

#### 4.2.4.1 Definition and overview

Epoxy-bound surface dressings are high-performance surface dressings which consist of a layer of resinous binder that is densely spread with high polishing resistant chippings. They consist of small-size aggregates (typically calcined bauxite 2/4). Although designed



to provide high levels of skidding resistance, they also provide good noise reduction performance. Figure 4.13 shows an example of an epoxy-bound surface dressing.



Figure 4.13: Example of an epoxy-bound surface dressing

The noise reduction performance has been demonstrated in a number of studies, e.g. [58, 59, 60] and it is considered that this is due to two factors:

- The initially liquid binder smoothes out any megatexture existing on the underlying surface;
- The closely packed array of thin stones forms a uniform, deep macrotexture.

There are several types of surface treatment, varying in the size and type of aggregates and the type of binder used. Most epoxy-bound surface dressings are proprietary surfaces. Examples of these types of surface are as follows:

- *PAVETEX*: A product developed in Japan that is used as a surface treatment [61]. It is described as unwoven polypropylene impregnated with chemical rubber and coated with a mixture of urethane resin and silica sand. The surface is then bonded to the existing pavement using an adhesive agent. The surface has been observed [61] to provide a noise reduction of 6-7 dB(A) for summer tyres and 3 dB(A) for studded tyres irrespective of speed and also demonstrated resistance to wear from studded tyres. The surface is claimed to have lasted for 16 months without problem, although no current information on this surface can be found;
- *ITALGRIP*: This is a proprietary surface developed in Italy and also used in the USA. It has been primarily developed to improve skidding resistance. It is applied to dense surfaces, either asphalt or cement concrete. An epoxy adhesive is applied to the existing surface to fill and cover any existing macrotexture. Before the binder is cured an aggregate, MC-I (manufactured from steel slag, with a size range from 1-4 mm), is spread onto the surface. The acoustic performance of ITALGRIP has been tested on a state highway in the USA [62]. The original cement concrete surface was first diamond-ground, reducing noise by 3 dB(A). The application of ITALGRIP then improved noise levels by a further 1 dB(A), i.e. 4 dB(A) relative to the original cement concrete;

- Sandberg and Ejsmont [10] reported on a fine surface treatment with 1-3 mm emery chippings which reduced noise levels by 3-4 dB(A);
- *GRIPROAD*: This is a German product which is suitable for laying on both asphalt and concrete pavements. The resinous binder is uniformly applied on the dry concrete or asphalt pavement and spread with chippings (maximum size = 4 mm). Chipping sizes of 1-2 mm, 2-3 mm or 3-4 mm can be used;
- *EP-GRIP*: This is an Austrian product developed by Possehl Spezialbau GmbH and is laid on concrete pavements to improve skidding resistance and to reduce traffic noise. Relative to a cement concrete pavement, the noise reduction potential of EP-GRIP is of the order of 4-6 dB(A). The laying process is similar to that for GRIPROAD.

#### 4.2.4.2 Advantages and disadvantages of the surface type

Epoxy-bound surface dressings are generally used at critical points on a road where a high skidding resistance is required, e.g. on sharp bends and at junctions. Due to the short implementation time, they are often used on bridges or in tunnels.

Under wet road conditions, the risk of aquaplaning is reduced by using epoxy-bound surface dressings compared to standard cement concrete pavements. Improved visibility in the rain or at dawn could be achieved by using light bauxite aggregates.

Generally epoxy-bound surface dressings show a noise reduction potential of about 2-4 dB(A) compared to the original cement concrete surface on which they are laid. As with EACC surfaces, the big advantage of epoxy-bound surface dressings is the roughly consistent noise reduction potential over the lifetime [57], and Figure 4.15 in Section 4.2.4.3).

Due to the small thickness of the surface treatment, the noise reduction potential is highly dependent upon the longitudinal evenness of the underlying layer. Although the acoustic and skidding performance of these surfaces is good, one of the most significant disadvantages is that the surfaces are rather expensive because all of the components are very high quality. Furthermore, there are significant difficulties in recycling this type of surface treatment.

#### 4.2.4.3 Typical performance data

Figure 4.14 compares the CPX Index<sup>5</sup> for newly laid EP-GRIP and GRIPROAD pavements (0-2 years old), as measured at a range of speeds on Austrian motorways, with that for a DAC11 reference surface. Figure 4.15 shows the increase in noise levels on these surfaces over a period of time compared to when the surfaces are newly laid.

<sup>5</sup> Details of the CPX method are given in Section A.2 of Appendix A.

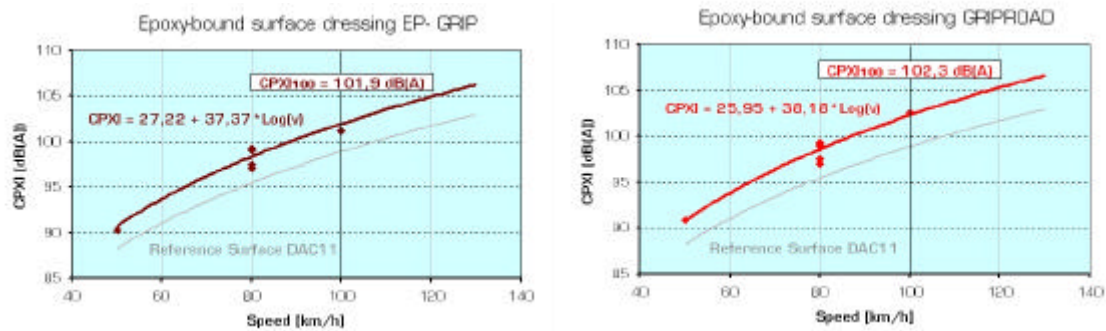

Figure 4.14: Rolling noise levels for EP-GRIP and GRIPROAD epoxy-bound surface dressings measured on Austrian Motorways [57]

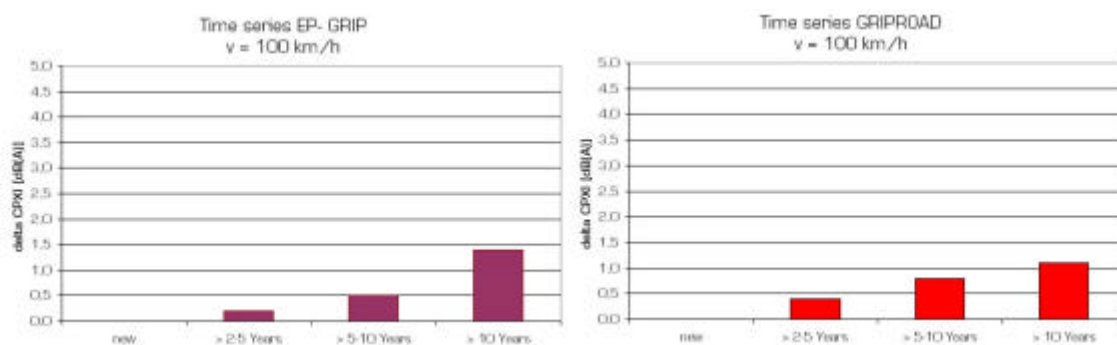

Figure 4.15: Noise reduction time series for EP-GRIP and GRIPROAD epoxy-bound surface dressings measured on Austrian Motorways [57]

### 4.3 Summary of the effects of low-noise road surfaces

Several studies in different countries have established the noise benefits of using the surfaces described in the previous sections. An Austrian research project carried out in the last years showed the influence of different road surface types, vehicles and tyres on the pass-by noise [63]. Figure 4.16 gives the summarised results of the 18 vehicle/tyre combinations for the six different surfaces examined. The results shown are for rolling noise at 80 km/h and 55 km/h and for full acceleration in 2<sup>nd</sup> and 3<sup>rd</sup> gear. In the following figure, the “most silent” vehicle/tyre combination and the range of noise levels are shown for every road surface.

The road surfaces included in the study were:

- TSF: *Thin bituminous surfacing – microsurfacing*;
- SMA: *Stone mastic asphalt*;
- PAC: *Porous asphalt concrete*;
- ISO: *Test surface conforming to standard ISO 10844:1994*;

- EACC: *Exposed aggregate cement concrete*;
- EP-GRIP: *Epoxy-bound surface dressing*.

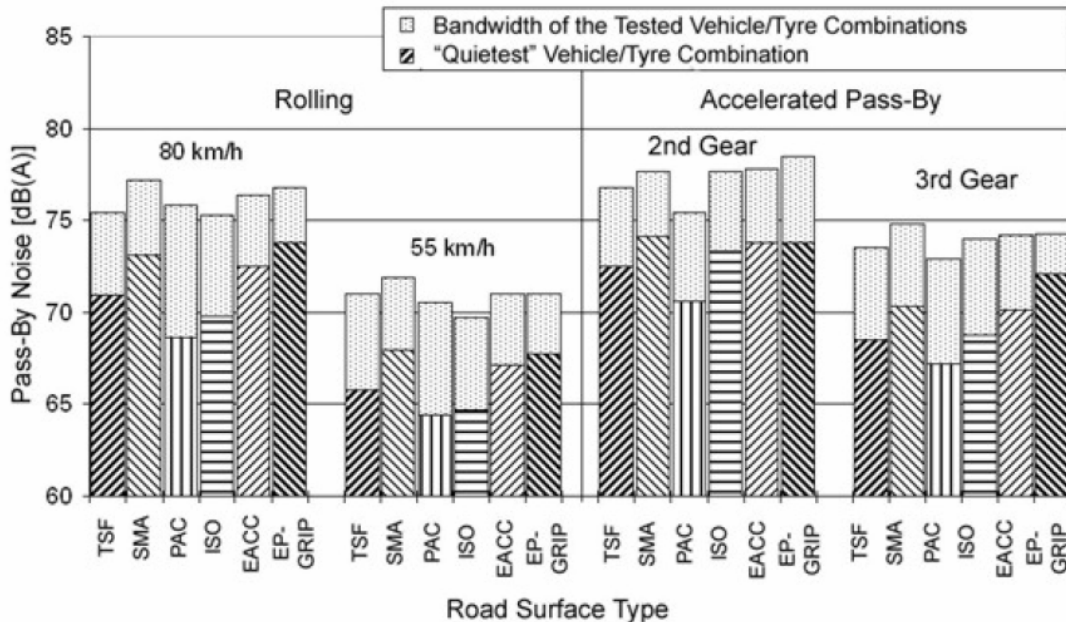

Figure 4.16: Pass-by noise from 18 different tyre/vehicle combinations on 6 road surface types [64]

The results shown in the figure demonstrate the large ranges found for different vehicle/tyre combinations for each surface and operating condition and the smaller but still significant range in noise levels between surface types.

Figure 4.17 shows the variation in SPB levels for passenger cars at 120 km/h measured on German roads relative to a Gußasphalt reference surface. These measurements were taken on various test stretches on highways that had been subjected to traffic over a period of one to six years. The "artificial lawn" surface is a longitudinally textured surface whereby the texture is applied with a matting (having bristles of 25-30 mm height and a weight of approximately 2kg/m<sup>2</sup>) rather than burlap. The range of results within a single type of cement concrete surface are a result of the different compositions of the concrete compounds and the largest aggregate size used. In the case of the ground concrete surface, only one surface was available for measurements.

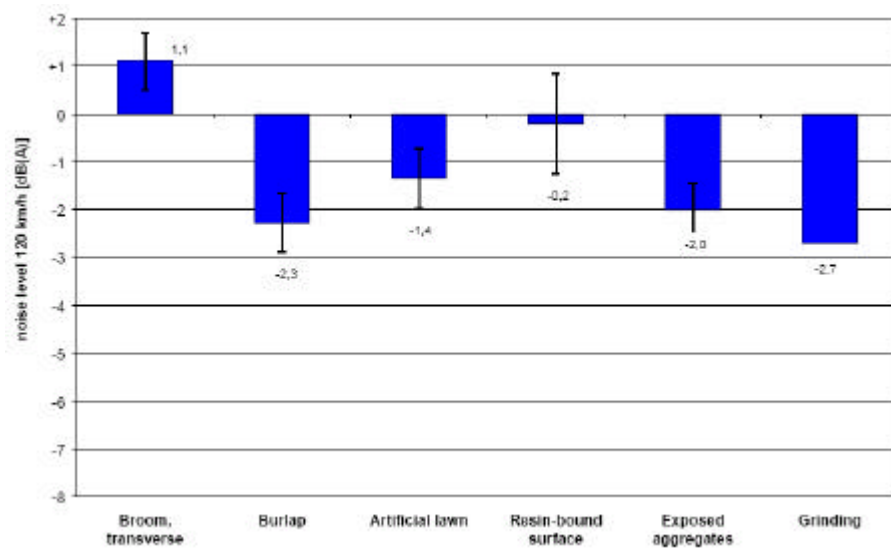

Figure 4.17: Variation in SPB levels (for passenger cars at 120 km/h) for concrete surfaces relative to Gußasphalt reference surface

Based on the results collated within the SILVIA project for the different surfaces described in the previous sections (see Tables 4.1, 4.3, 4.4, 4.5, 4.7), Figure 4.18 - Figure 4.20 summarise the results for all surfaces in terms of SPB levels on low, medium and high speed roads<sup>6</sup>. Two “reference” surfaces are shown on the Figures for illustrative purposes:

- Surface “Ref #1” (medium-speed roads only) is based on the virtual reference surface reported in Annex D of ISO 11819-1, i.e. the average of SPB data for asphalt concrete (2-10 years old, 11-14 mm chippings) and stone mastic asphalt (3-7 years old, 12-16 mm chippings);
- Surface “Ref #2” is a virtual reference surface based on the average of SPB data for all of the DAC and SMA surfaces with 11-16 mm chippings reported in the SILVIA report “Acoustic performance of low-noise road pavements” (SILVIA-DTF-DRI-010-01-WP4-290605).

It is important to note when comparing the noise levels shown in these figures that they are average values derived from surfaces having a wide age range, i.e. not all of the surfaces were tested at the same age.

The results illustrate that there can be large variations in the maximum pass-by noise level across similar surfaces for a particular vehicle category e.g. about 10 dB(A) for cement concrete surfaces on high speed roads. It is likely that this variation is dependent on the age and degree of trafficking with the general trend that noise levels increase as the surface ages.

<sup>6</sup> According to ISO 11819-1, the following definitions apply: “Low-speed roads” are defined as being those where traffic operates at an average speed of 45-64 km/h; “Medium-speed roads” are defined as being those where traffic operates at an average speed of 65-99 km/h; “High-speed roads” are defined as being those where traffic operates at an average speed of 100 km/h or more, though heavy vehicles may operate at a lower average speed due to speed restrictions

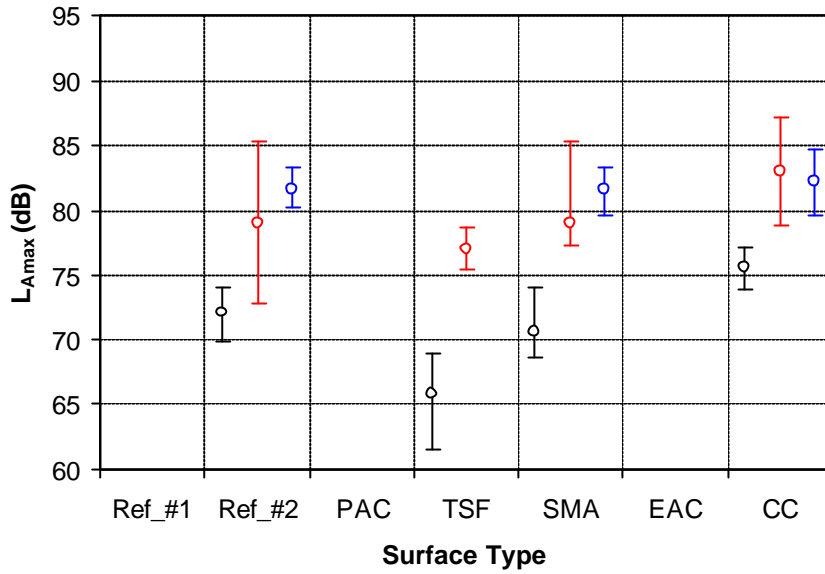

Figure 4.18: Comparison of average SPB noise levels for different surfaces on low-speed roads; error bars show maximum and minimum noise levels for each pavement type. ● Cars, 50 km/h; ● Dual-axle heavies, 50 km/h; ● Multi-axles heavies, 50 km/h. Surface Types: Ref\_#1: Virtual reference surface; Ref\_#2: Virtual reference surface; PAC: Porous asphalt concrete; TSF: Thin surfacings; SMA: Stone mastic asphalt; EAC: Exposed aggregate cement concrete; CC: Cement concrete

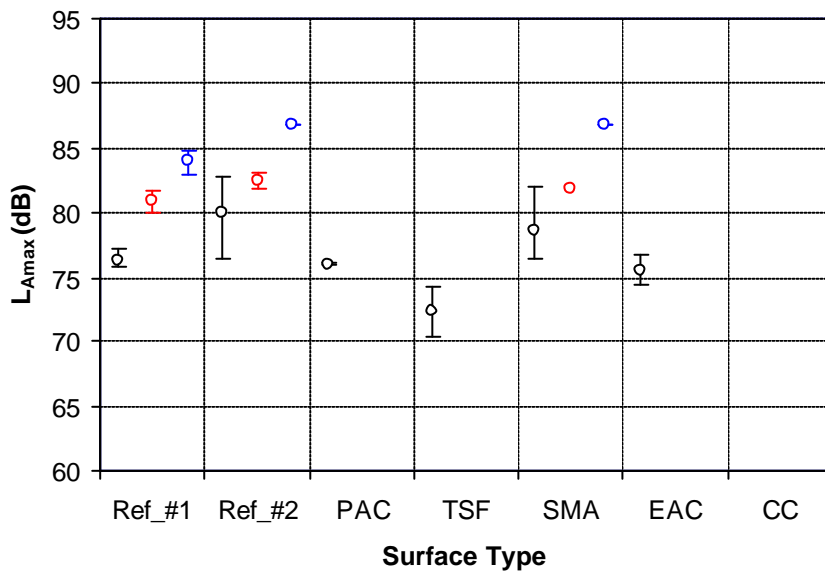

Figure 4.19: Comparison of average SPB noise levels for different surfaces on medium-speed roads; error bars show maximum and minimum noise levels for each pavement type. ● Cars, 80 km/h; ● Dual-axle heavies, 70 km/h; ● Multi-axles heavies, 70 km/h. Surface Types: Ref\_#1: Virtual reference surface; Ref\_#2: Virtual reference surface; PAC: Porous asphalt concrete; TSF: Thin surfacings; SMA: Stone mastic asphalt; EAC: Exposed aggregate cement concrete; CC: Cement concrete

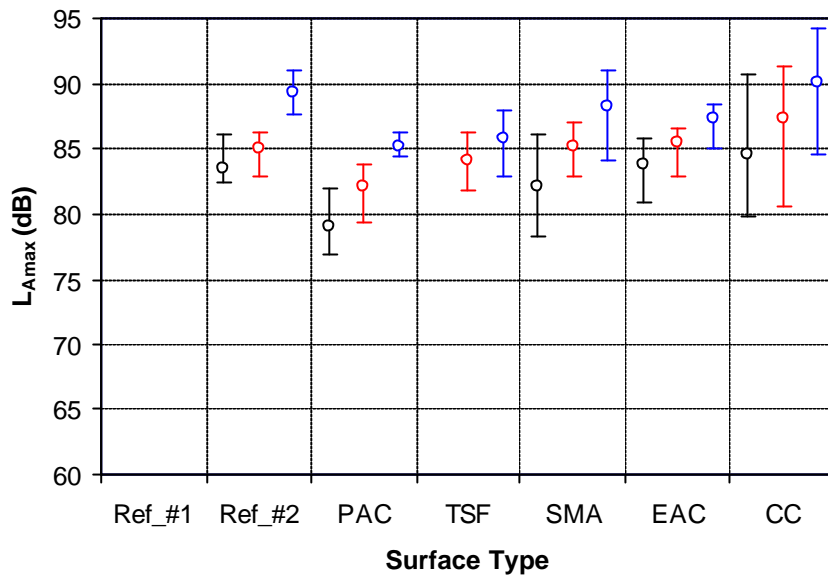

Figure 4.20: Comparison of average SPB noise levels for different surfaces on high-speed roads; error bars show maximum and minimum noise levels for each pavement type. ● Cars, 110 km/h; ● Dual-axle heavies, 85 km/h; ● Multi-axles heavies, 85 km/h. Surface Types: Ref\_#1: Virtual reference surface; Ref\_#2: Virtual reference surface; PAC: Porous asphalt concrete; TSF: Thin surfacings; SMA: Stone mastic asphalt; EAC: Exposed aggregate cement concrete; CC: Cement concrete

The figures have been included to illustrate the range in noise levels encountered from different types of vehicles travelling on different road surfaces over different speed ranges. As the road type changes from low to high-speed roads the variation in the maximum pass-by noise level across different vehicle categories is reduced due to the wider speed variation between cars and heavy vehicles. For low speed roads where all the traffic is travelling at similar speed i.e. on average about 50 km/h, variation in noise from different vehicle types across the surfaces studied is shown to be about 25 dB(A) compared with less than 20 dB(A) for high-speed roads.





## 5 Review of existing construction and maintenance techniques

The previous Chapter of this Guidance Manual provides details of the different types of low-noise surfaces that are currently available across Europe, their physical composition, and information on their acoustic properties. This chapter addresses the production and maintenance techniques for these surfaces and, where applicable, how they can be recycled.

### 5.1 Existing production/construction techniques

#### 5.1.1 Asphalt surfaces

These surface types may be utilised for different types of construction work, i.e. the maintenance, rehabilitation and construction of new roads. Although these three types of work use different methodologies to meet specified requirements, the production is principally the same for all of them, including manufacture, transport-, and paving operations (i.e. surface preparation, laying, and compaction). Low-noise surfaces are in general characterised by a relatively high volume of open and interlinked voids (e.g. porous asphalt) or by an optimised texture (e.g. thin surfaces). As these open-, or gap-graded mixes are in general made up of a high proportion of high quality single-sized aggregate, modified binder, and additives, some specific modifications and a well-controlled production operation must be taken into account to standardise production.

Although the general specifications, conditions and applications of low-noise surfaces vary in different countries, the objective of the actual production process may well be the same or similar. General experiences and practice of successful production measures are outlined and discussed in the following sections. It should be noted that these measures might not be applicable in all countries due to specific local conditions and restrictions. Adaptation to local conditions is always required. Nevertheless, high productivity, uniform quality and the economics of a project are all dependent on the close integration of the production process. Although a detailed explanation of the production aspects of asphalt mixes is beyond the scope of this section, it is appropriate to provide a brief overview of the most basic principles. A more detailed description can be found elsewhere, e.g. [65, 66, 67, 68, 38]

##### 5.1.1.1 Manufacture of asphalt surfaces

Low-noise mixes can be produced in either continuous plants, or in drum-mixing facilities. The asphalt plant can be mobile or stationary. Evidently, the constituent components of the mix (aggregate, binder, filler, and additives) as well as the composition all have a significant influence on the in-situ performance of the mix. Given the large variety of constituent mixture materials and composition utilized within Europe, it is impossible and useless to try and specifically define proper low-noise surfaces. Nevertheless, general functional requirements and desirable properties can be used in combination with local requirements to achieve and produce durable low-noise pavements.

In general, the traffic loading and the environmental conditions govern the required functional properties and characteristics of the mixture components and composition respectively. In this respect the selection of materials is critical to the performance; the aggregate and binder as well as the mixture compositions are the most important considerations.

Since the mix comprises more than 90% by weight of aggregate, the quality of the mix is highly dependent on the quality of the aggregate. Crushed aggregate is therefore preferable. Since, the traffic induced loads are transferred between a relatively few point-to-point contact areas between the aggregate particles, then high quality aggregate is generally required. In addition, in circumstances where there is considerable traffic intensity and/or the frequent use of studded tires, then the aggregate must have a high resistance to abrasion. A cubic aggregate shape improves resistance to abrasion as well as providing for a large air void content. A small maximum stone size is favourable for noise reduction whereas a large maximum stone size improves the durability and the draining capabilities. It appears therefore that some of the desired properties are contrary to one another [65]. The ultimate choice will be dependent upon the conditions and situation where the low-noise surface will be applied. A dry, well-graded aggregate is the basis of a good quality low-noise surfacing.

Although the binder is a minor part of the mix (approximately 4-7% by weight), it governs the behaviour to a great extent. The behaviour of binders is governed by their initial properties as well as by the mechanical and environmental conditions to which they are subjected. Conventional binder might be used for applications with low requirements whereas modified binder is typically required for high performance mixes. The selection of the bitumen must be in line with the temperature range of use and the properties of the aggregate to ensure a durable adhesion between the binder and the aggregate. Special care must be taken with the binder to adhere to the manufacturer's instructions. This is especially important in the case of modified binders. In general the control of the temperature of the binder is more important for low-noise pavements than for conventional bituminous mixes, i.e. the handling and production temperature of the binder. The production temperature is one of the factors that has the greatest influence over the quality and performance of the surfacing since it varies with the type of binder used. If the temperature is too high, the binder becomes more fluid and the risk of dripping is increasing. Excessive temperatures might significantly damage the binder, which will result in a reduced life of the surfacing.

The durability of the mix might be improved with appropriate additives, and polymers are normally integrated into the binder and the mixture. The additives and modified binder are used to reduce the susceptibility of hardening (oxidation) and to improve the adhesion between the binder and the aggregate. Typical additives are fibres (i.e. mineral or cellulose fibres or a mixture thereof), and fillers (e.g. amines, cement or slaked lime). Fibres are used as a drainage inhibitor to increase the viscosity of the binder and to allow for a higher content of bitumen; filler may be added to improve adhesives qualities. Different types of rubber and polymers can be used to improve the binder properties according to the desired properties of the mix. The selection of an appropriate binder generally depends on the required improvements and the available aggregate. Polymer modified binders may be customized to suit specific requirements. The polymers may be added either to the mix batch, i.e. PMA (Polymer Modified Asphalt), or blended with the binder, i.e. PMB (Polymer Modified Bitumen). Care should be taken to achieve a homogeneous distribution of the polymers in the mixture regardless of the type of

polymers being used. An additional bitumen tank may be required in cases where PMB is used.

Fibres may be added in loose or palletized form. The fibres are preferably added using a mechanical feed device to reduce manual labour and to minimise operator error. These feed devices help control the consistency of the fibre content in the mix. Typical dosages are around 0.3% for cellulose fibres and approximately 0.4% for mineral fibres [68]. A mix of mineral and cellulose fibres may also be utilised with good results. Fat spots, i.e. concentrations of fibres in the mix, are likely to result on the surface if the fibre content is not controlled or if the fibre is not thoroughly dispersed in the mix.

Filler material might be natural or produced. In the Netherlands there is a requirement for 25% direct solvable calcium hydroxide [65]. The use of filler might improve the adhesive capacity of the binder and the aggregate.

Modern plants are generally governed by automatic controlled production operations regarding the proportioning of the different recipes. Thus, all constituent materials may be controlled and added to the batch according to a specified recipe. Since open-graded mixtures predominantly consist of a single size aggregate, sufficient attention must be paid to the aggregate supply as well as the screening capacity of the screen deck of the batch plant. When the different constituents are weighed and added to the batch, they have to be mixed according to a set pattern to achieve a homogeneous mix. Mixing times will vary according to the mix and type of mixer. The use of polymers and additives, i.e. fibres, will generally increase the mixing time by between 15-30 seconds [68]. When fibres are used in the mixtures, both the dry and wet mixing time may have to be extended to achieve a complete and uniform distribution of fibres and coating of all the aggregate particles with bitumen. At this stage, it is important that the production temperature is kept within specified limits as this is one of the factors that has the greatest influence on the quality and performance of the mixture. Overheating of the aggregate may damage the bitumen and too low a temperature may not be sufficient to dry the aggregate so that future adhesion damage between the aggregate and bitumen, i.e. stripping and ravelling<sup>7</sup>, may occur. Too high a temperature may also increase the separation of the binders in the mixture during storage, in the truck during transport and during laying.

#### **5.1.1.2 Transport of asphalt mixes**

When the homogeneous mixture has been produced in the plant it is then transported to the work site and delivered to the hopper of the paver. The mixture should be transported to the work site as soon as possible or temporarily stored in a surge silo; in this case the storage should be as short as possible.

It is important that the transport is done without delay and without any change in the characteristics of the mix during the delivery process. The asphalt material should be transported such that there is as little change in temperature as possible. This may be achieved by use of adequately insulated round-bottom trucks with covered beds. The transport distance is particularly important in low temperatures; the mix must arrive at the work site so that it can be placed when the temperature of the mix is within a specified range. If long transportation distances are necessary, the use of mobile transfer vehicles should be considered for remising the material at the work site in front of the paver to minimise temperature variations in the mixture. The use of transfer vehicles can also

---

<sup>7</sup> Stripping is defined as being the loss of binder from the surface of the aggregate in asphalt pavements. Ravelling is defined as being the loosening of stones from the surface of a pavement.

improve capacity as the paving operation can be performed continuously without any unnecessary breaks or interruptions.

In addition, if mobile transfer vehicles are used, the mixes will normally only lose a few degrees of temperatures on delivery to the paver. Open-graded mixes that contain excess bitumen will tend to drain while stored temporarily in a surge silo and during transportation to the work site by a truck. The transportation time should be as short as possible. Isolated and tarpaulin-covered trucks should be used to minimize excessive cooling of the mixture. The mixture should arrive at the paving site so that it is laid within the appropriate temperature range for the surface type. Well-planned production and good coordination of transportation are essential to ensure an even flow of material to the worksite.

### **5.1.1.3 Paving operations for asphalt surfaces**

Prior to the laying of open-graded surfaces, the underlying substrate should be checked to confirm that it is suitable for the application of such mixes. The substrate should be impervious and have a good resistance to stripping. A normal tack coat<sup>8</sup> can be applied to the substrate, e.g. 0.3 kg/m<sup>2</sup> of binder emulsion [65]. The underlying layer should also be sufficiently even and have sufficient cross-fall so that water can run from the layer away from the road.

Conventional construction equipment and technology are used to construct low-noise pavements. Special care must be taken to select the most suitable equipment from the different types that are available. A paver with large traction force is preferable for open-graded mixes from the perspective of evenness. For thin layers, a paver fitted with a spray assembly for applying the emulsion tack coat might ease the production and improve the durability of the surface. The selection of the roller should be based on the degree of compaction of the surface required. A static roller of 10-12 tonnes might be appropriate for an open-graded mixture [38], whereas a vibrating roller might be a better choice for thin layer mixes [66, 67].

At the work-site, the asphalt mix is placed and pre-compacted by asphalt pavers over an existing surface. In order to achieve a satisfactory result, it is particularly important that the position, thickness, gradient, and cross-slope of the laid mix can be controlled. Final compaction is done by rollers. An optimal degree of compaction is vital to ensure that adequate strength and durability of the asphalt layer is achieved. The compactability of an asphalt mix is highly affected by its temperature. If the temperature is too high, the mix might simply be pushed in front of the roller and/or cause binder separation in the asphalt mix. On the other hand, if the temperature is too low, adequate compaction is very difficult, if impossible, to achieve. Furthermore, high performance mixes exhibit a narrower temperature window within which adequate compaction is possible. Inadequate compaction increases the risk of premature distresses of an asphalt pavement, i.e. permanent deformation (rutting), fatigue (cracking), bitumen oxidation and stripping. In general, observed disintegration in asphalt mixes can often be assigned to inadequate compaction. Therefore, to reach an optimal degree of compaction, it is very important that the compaction is carried out within an appropriate temperature range uniformly over the entire paving area.

Low temperatures and windy weather conditions significantly influence the rate of cooling of open and thin low-noise mixes which reduces the time available for achieving sufficient compacting. Insufficient compaction will lead to decreased durability, resulting in the top

---

<sup>8</sup> A tack coat is a thin film of binder, such as bitumen or emulsion, which is sprayed on to improve the adhesion between layers of asphalt.

layer having a poor resistance to ravelling. Construction of double-layer porous asphalt is recommended to be performed using “warm-in-warm” technology (sometimes referred to as “hot-in-hot”), where the two porous layers are laid simultaneously, to improve the adhesion between the two layers as no tack coat needs to be used; this method uses two pavers or a specialized single paver which lays the two porous layers simultaneously. The procedure improves the capacity and also the time available for compaction. Furthermore, the method can prolong the time period (time of day or time of year) in which these surfaces can be laid. Important factors that must be considered in using this method are the capacity of the plant, the transport of the two different mixes to the paver and the overall logistics. Adequate production control is again the key to success. Production control of the mixture temperature is recommended to detect temperature differentials in the delivered mixes such that inhomogeneous properties are avoided in the paved and compacted surface.

This warm-in-warm/hot-in-hot technology has already been used for a long time in Japan. Using a so-called “Multi-Asphalt Paver” machine, the Seikitokyu Kogyu company has paved approximately 80,000 m<sup>2</sup> of double-layer porous asphalt during the last 5-6 years [69].

Smoothness of the low-noise asphalt is essential to achieve good noise reduction. The smoothness of pavements is less a function of rolling and more a result of best-practice paving and screed operation. The initial evenness obtained by the paver will remain intact; a combination screed<sup>9</sup> with a high level of pre-compaction is preferable. The easiest way to boost smoothness is to avoid stopping and starting the paver, which can result in bumps in the mat. Crews should make sure that the paving machine always has hot mix in front of it, so that there is no need to stop and wait for another load. The use of transfer vehicles may be beneficial in this respect.

At present, a typical asphalt laying operation includes a paver and different types of rollers that work in combination with each other. The paver operator controls the thickness and the position of the laid mix, either visually or by hand. The compaction is governed by a rolling pattern that specifies the required number of passes over the entire paved surface. Practically, this rolling pattern is very difficult to achieve as the roller operator has no support other than his own experience and judgement. In addition, collection of relevant as-built information is very cumbersome.

Consequently, there is a considerable demand to control the use of resources and machines during the laying operation that could assist the paver and roller operators. This would significantly contribute to a more uniformly compacted asphalt layer, improved collection of as-built information, and thus, improve the overall quality of the road construction.

Currently there are a range of separate digital systems available on the market to support certain phases of the road construction, i.e. design, setting-out, levelling, compaction and assessment. However, the information of many of the construction phases cannot adequately be used as an input for the next phase given the non-compatibility of the different systems. Moreover, the mentioned systems are generally not component-oriented and not configurable.

---

<sup>9</sup> A combination screed" is a screed which compacts the mix by means of vibrator AND tamper; i.e., it combines two means of compaction (this does not, however, eliminate the need for rolling). An alternative and probably more common term is "tamper and vibration screed".

Increasingly, the construction machines are equipped with sophisticated sensors and digital networks, but the digital data is generally lost after the work is completed due to a lack of mobile services and database infrastructure. Within the European project OSYRIS (Open System for Road Information Support, 2000-03), an open, supportive system for the construction, maintenance and rehabilitation of roads, mainly focused but not limited to asphalt operations, a range of products was developed and validated with the objective of filling these missing links and providing a common infrastructure with open interfaces which could be used to the advantage of specialised components [70].

These actions can lead to improved quality and control of quality, resulting in an increased service life of the pavement. In addition they contribute to reduced maintenance operations and decrease the time on the road for performing these activities. This is and will be even more important in the future as it minimizes both the traffic interference and the safety of the workers, respectively. It was shown that the OSYRIS system could support contractors in achieving the appropriate quality and increase cost-effectiveness and competitiveness within the asphalt industry [70]. It is considered that an OSYRIS-type system would definitely improve paving operations with regard to low-noise surfaces.

#### **5.1.1.4 Compaction of asphalt surfaces**

The quality of the pavement with regard to durability depends to a great extent on the degree of compaction achieved in the finished pavement. Even if the voids ratio and degree of compaction are very much dependent on the composition of the mix, i.e. binder content and modification, aggregate grading, particle shape, etc., it is of utmost importance that the compaction work is carried out as satisfactorily as possible. Thorough knowledge of the compaction capability of different rollers as well as skill in handling the rollers is required to achieve the optimum compaction effect. Adequate compaction is considered one of the most factors affecting the durability of an asphalt layer. There are clear indications of relationships between degree of compaction and many performance related asphalt properties such as resistance to rutting and cracking. If a surface is compacted poorly and unevenly, its durability and noise reduction performance will be significantly reduced.

High-performance rollers have been developed to improve the compaction of new asphalt mixes with different compaction demands compared to conventional mixes. However, the skill of the operator is still the key for an adequate result. A new generation of high performance compactors is evolving which can provide ultra high vibration, and vary amplitude (force) with vibration (frequency) according to the type of asphalt and aggregate being placed, thus avoiding dangerous over-compaction. Crushed aggregate mixes may require a greater compaction effort to achieve the required level of density than mixes containing rounded gravel. The compaction effort is generally less compared to that required for dense-graded mixtures. Due to the aggregate gap-graded structure, the contribution of the roller to the final compaction is limited.

Compaction of open-graded mixes and thin-layer applications requires particular attention, especially on a cold substrate and at lower temperatures and in windy conditions when cooling will be rapid and early compaction crucial. Again, actions should be taken to ensure that the mixtures are compacted within the correct temperature range. In addition, several factors, such as lift thickness, base support, base temperature, wind velocity, air temperature and asphalt viscosity affect the compaction.

Mixtures containing high-viscosity binder and crushed aggregate with a high stone content have a high resistance to compaction. Therefore, manual laying should be avoided if possible as it is difficult to obtain the optimum evenness, durability and density of the mixture. Too heavy rolling, e.g. with rollers that provide a high pressure, vibrating rollers, etc. may introduce extensive aggregate crushing that reduces the noise reduction performance and the durability of the mixes.

### 5.1.2 Cement concrete surfaces

Cement concrete pavements were originally laid using concrete slabs with the joints between the slabs being designed as expansion joints. More recently, only contraction joints were used in conjunction with slip-form technology between the slabs in order to enhance the transmission of lateral forces.

Cement concrete are now generally laid using a slip-form paver which is the width of the carriageway. What distinguishes this equipment is the fact that it is compact. The concrete is distributed and compacted, dowels and anchors are placed, the concrete is then smoothed and the formwork is removed. Figure 5.1 shows an example of a slip-form paver. Although two independently operated pavers were at one time used consecutively to lay double-layer or two-grade pavement, complete single systems are now available which are capable of performing the complete procedure.



*Figure 5.1: A slip-form paver in operation*

The layer is compacted using an internal vibrator in the press box. A transverse smoother behind the press box provides the closed pavement condition and a longitudinal smoother used to ensure evenness. The surface is then structured as described in Section 4.2, depending upon the type of finish required.

The concrete surface layer has become increasingly thicker with increasing traffic congestion. Nowadays, depending on the type of base course, concrete surfaces 260-300 mm thick are being manufactured in the highest construction category. Base courses with hydraulic binder and concrete coverings are preferred due to their full-surface support. However, water ingress combined with the pumping effects of the concrete slab can generate a separation of the bond between the base course and the concrete and an erosion of the base course. This frequently resulted in premature damage to the concrete layer itself. Installing a non-woven fabric in between the concrete layer and the base course with a hydraulic binder or a non-bonded crushed gravel base course prevents the building up of water that causes this damage.

The surface structure of concrete pavements changes due to the influence of weather and traffic. It passes through several stages as this process occurs since the area close to the surface of the pavement is comprised of different materials in zones as shown in Figure 5.2. The top zone is primarily made of hardened cement stone produced during production. Sand is added to the zone below. These two upper zones together constitute the *surface mortar*. It is only when these two zones have been worn out either through wear from traffic or weather influences or have been directly removed right from the beginning as a result of laying the pavement as an exposed aggregate concrete pavement that the actual concrete mixture in the third zone will be directly exposed. The first phase, when the pavement is of a young age, is characterised by the structure of the fresh surface mortar. During the second phase, which usually lasts several years as the surface wears, the sand dominates. The third and final phase is determined by the texture and size of the exposed coarse aggregate.

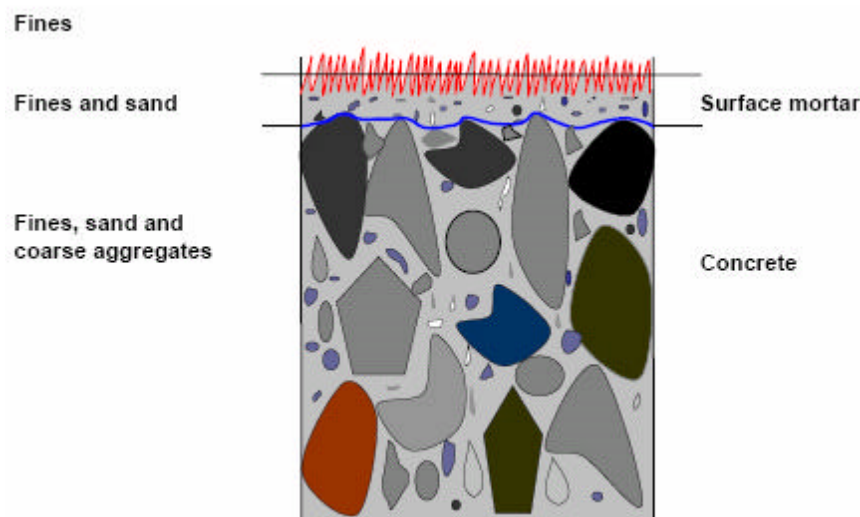

Figure 5.2: The different upper zones of a concrete pavement

## 5.2 Maintenance on porous asphalt

Since porous asphalt is more exposed to the atmosphere than other non-porous asphalt surfaces, the binder used is more susceptible to oxidation leading to embrittlement,



cracking of the surface and loss of aggregate. If this occurs then major maintenance of the road may be necessary. However, in some cases the life of the binder can be extended through the application, in-situ, of rejuvenators. The method consists of spraying the surface with a diluted emulsion. This creates a new coating for the mineral aggregate, which, through diffusion processes, improves the viscosity properties of the hardened binder.

If the binder has reached the end of its effective life then the whole of the surface layer has to be removed. This is normally achieved by cold or warm milling of the porous asphalt layer. A new layer can then be applied to the existing road base. When replacing the surface layer it is, of course, important to ensure that the road base is in good condition and capable of supporting the new surface for its anticipated life expectancy. It is also very important to make sure that the water system used previously for drainage is also intact and operating efficiently.

One approach for the maintenance of porous asphalt is known as “variable pavement maintenance”, as used in the Netherlands. This can be lane-wide or carriageway-width replacement of the road surface. The normal approach using this method consists of two-steps. The first step is maintenance on the deteriorated PAC dressing in the slow (nearside) lane of the carriageway. The second step, which is only carried out when the surface in the fast lanes of the carriageway has deteriorated, is to remove and relay the PA dressing over the *full-width* of the carriageway.

Replacement of the road surface in the slow lane is known as the “*out/in method*” [71]. However, two alternative methods which are less expensive than the “out/in” approach have been investigated. These techniques, “*sealing*” and the application of “*open graded emulsion asphalt*”, have so far only been used in the first step of the normal Dutch maintenance scheme. It is anticipated that the methods could also be used in the fast lanes, in which case it would be necessary to use them repetitively on the slow lane. Furthermore, these other techniques are not applicable as a measure to repair rutting damage, structural damage (cracks) and to correct for low skid resistance as a result of polishing of the surface.

The “out/in method” comprises the removal of the old PAC road surface and the laying of a new surface in its place. The normal procedure involves the following steps:

- The slow lane is scarified to remove the old surface;
- The working lane and adjacent lanes are then swept clean;
- During rolling on the slow lane, care must be taken to avoid damaging the PA surfaces of the adjacent lanes (rolling on the existing material in the adjacent lanes causes crushing of aggregate and a reduced permeability);
- Finally, the adjacent lanes are then sealed using a sealing agent; additionally that part of the existing surface in the slow lane which extends 25 m in either direction from the repaved section, should also be sealed.

The technique called “**sealing**” uses a bitumen emulsion containing a binder rejuvenating agent (see Section 5.4).

The other technique involves the application of “*open graded emulsion asphalt*”. This is a mixture of bitumen emulsion, cement, filler, and a mixture of sand and stone aggregate of a suitable grading (1/3). It is applied in a thin protective layer on aged PAC 0/16 surfaces that exhibit light or moderate ravelling. The pavement’s texture, noise reduction and skid resistance are improved without any great loss of permeability. The bitumen emulsion rejuvenates the aged bitumen in the pavement surface while the aggregate consolidates the pavement surface against further stone loss. Road trials [72] have indicated that the service-life of PAC surfaces can be enhanced by 4 years or more. Life cycle cost analysis has indicated that an estimated 12% reduction in maintenance costs over the life cycle should be feasible.

### 5.2.1 Weed Control

Unwanted plant growth on PA road surfaces can occur at locations where there is almost no traffic and growing conditions are favourable, e.g. the emergency lane on motorways. Under moist conditions plant growth can result in reduced safety performance, e.g. reduced skid resistance, and the presence of roots within the porous surface can cause ravelling. Excessive plant growth also gives the impression to the road user that the roads are poorly maintained.

One form of preventive measure is to not lay the PA surface right up to the verge, i.e. maintain a narrow strip, approximately 200-300 mm, of the underlying DAC layer between the verge and the PA. This will prevent plants growing from the verge into the road surface in the first instance.

Although brushing is a very effective measure for controlling weeds on dense surfaces, on PA road surfaces brushing and normal water pressure cleaning techniques are not sufficient. Since the use of herbicides such as glyphosate is often not permitted, alternative methods for weed control have had to be evaluated. Examples of these methods are as follows:

- Even very low traffic usage has been demonstrated to have a positive effect on weed control. Studies have indicated that running traffic on the emergency lane for a single day offers benefits for control on that lane and that performing this twice a year is probably sufficient for most cases. However, there are disadvantages to using this approach, namely the cost of traffic control and the effect on traffic flow;
- Application of salt ( $150 \text{ g/m}^2$ ) in a concentrated saline solution during periods of dry and sunny weather conditions have been shown to be very effective. Lower concentrations in combination with plant-damaging treatments such as brushing can also be effective. However, the approach is not effective in wet conditions. The adverse environmental effects of salt application are also less than those glyphosate application;
- The application of hot water has been examined but found to be relatively ineffective and only suitable for use on a small scale. The application of steam is more effective than hot water, but will result in reduced visibility for passing vehicles.

None of these measures are ideal for the control of weeds on PA road surfaces. However, it should be noted that plant growth is generally a localized problem; custom-made

solutions are therefore the most effective solution since they can be designed to be suitable for the local conditions.

## 5.3 Maintenance of concrete pavements

The following is a *brief overview of methods* available for the maintenance of concrete pavements. More detailed information can be found in the listed references.

The maintenance treatments are categorised as non-structural maintenance, medium-term repairs, long-term repairs and rehabilitation/strengthening techniques. The structural maintenance treatments are categorised here as in the new Concrete Pavement Maintenance Manual (CPMM) [186].

It should be noted that the maintenance of asphalt overlays on concrete pavements are not addressed in this document.

### 5.3.1 Non-structural maintenance

#### 5.3.1.1 Restoration of surface texture and noise reduction

Several different methods are available for restoring the surface texture of concrete roads in order to restore the skidding resistance (e.g. see HD 32 in [187], the suitability of which depends on the road type, traffic speed, risk factor and the aggregate used in the concrete. Some methods will only restore the macrotexture or the microtexture, whilst others will restore both. However, most of these techniques, with the exception of the thin asphalt surfacing, will result in an unacceptable increase in noise generated at the tyre/road interface. The available methods include the following:

- Laying thin asphalt surfacings on top of the existing concrete;
- The application of surface dressings;
- Transverse grooving;
- Mechanical roughening, whereby improved skidding resistance may be achieved by roughening the worn surface using of abrasive blasting, scabbling or milling equipment;
- Thin-bonded surface repairs

#### 5.3.1.2 Emergency repairs

*Partial depth emergency repairs* may be required in situations where the depth of the defect is relatively shallow, or where the structural integrity of the parent concrete beneath the defect is sufficient to allow the restoration of a smooth running surface to be the only short term objective. Normal asphalt and special proprietary materials using 6-10 mm aggregate and thermoplastic materials are appropriate for this purpose.

For *full depth emergency repairs* dense bituminous macadam, hot rolled asphalt or concrete may be used. Alternatively, suitably sized pre-cast concrete slabs can be used, provided they are properly levelled and seated on the existing sub-base to prevent rocking.

### 5.3.2 Medium-term repairs

The CPMM [186] indicates that medium term repairs are appropriate when a pavement is estimated to be about five years away from major rehabilitation/strengthening, and when the occupation time required for the repair must be minimal, and this is judged to be more important than the longevity of the repair. The purpose of the repair is to maintain the pavement in a safe and serviceable condition for 5 – 7 years. Methods for carrying out medium-term repairs include:

- Diamond grinding: See Section 4.2.3 of SILVIA manual and also [188];
- Crack sealing: See for example, [189];
- Cementitious and polymer modified repairs: This repair technique, also called *partial-depth patching* or *spall repair*, is used to permanently repair spalls, potholes and other forms of distress that extend to less than half the depth of the slab. See for example, [190];
- Full depth corner repairs: The CPMM indicates that a significant proportion of full depth corner repairs fail by separation from the original concrete and local settlement, well in advance of the failure condition being reached in the original pavement. When undertaking corner repairs it is desirable that as large a 'chamfer' as possible is provided across the corner to reduce the risk of a crack subsequently developing across the slab from that point;
- Restoration of slab support: Performed by either vacuum grouting (HD 32 in [187]), pressure grouting (HD 32 in [187]) or subsealing/slab stabilisation (which serves to fill small voids that develop beneath the slab due to pumping, e.g. [190]);
- Joint resealing: Pavement joint sealants suffer from accumulated distress over time due to the ongoing expansion and contraction of the joint, natural ageing and long term exposure to the environment. Generally a joint sealant has a life of 5 – 7 years, and this lifespan places joint sealing in the medium term repair category.

### 5.3.3 Long-term repairs

Long term repairs are generally appropriate for pavements where the residual life has been estimated to be in excess of 7 years. Methods for carrying out long-term repairs include:

- Thin bonded arris repairs: Performed using either cement mortar or fine concrete depending on the depth of the repair;
- Thin bonded surface repairs: The CPMM [186] states that shallow depth defects such as surface scaling, cobweb cracking and pop-outs may occur in slabs at areas remote

from joints. Thin bonded surface repairs, similar to those used for arris repairs, may also be applied to these defects;

- Restoration of dowel bars for joint/crack load transfer [191,190];
- Installation of slab edge support: Congress and Darter [192] report that many concrete pavements exhibit distress resulting from loss of support beneath the slab edge and transverse joint. This causes an increase in the corner and edge deflection of the slab, which results in corner breaks, transverse and longitudinal cracking, and faulting. One approach to the reduction of these distress types is the construction of a rigid edge support;
- Stitched crack repairs: Performed using *staple tie bars* or *diagonal tie bars* [186];
- Slab replacement [186];
- Slab lifting [186].

### 5.3.4 Rehabilitation and strengthening techniques

Rehabilitation techniques are required when particular performance aspects are below the desired threshold criteria and may be compromising safety. Examples of this are the loss of skidding resistance, the loss of horizontal or vertical alignment or a requirement to improve the surface noise characteristics. Strengthening is usually required when either, the residual life of the pavement has expired and periodic maintenance has become uneconomic, or, when predicted increases in traffic indicate that the pavement will quickly become unserviceable.

As a result of the requirements of the UK Government's ten year plan [193] a low noise asphalt surfacing would be required to be placed over any rehabilitation or strengthening technique that results in a concrete running surface in order to provide satisfactory noise reduction characteristics. These overlays can include:

- Thin bonded concrete overlays [192, 187];
- Thick unbonded concrete overlays: These are most appropriate for pavements with a degree of structural or other deterioration. The technique uses a separation interlayer to absorb slab movement and prevent reflection cracking;
- Structural asphalt overlays: These consist of usually more than one layer of asphalt bound material giving a total thickness of 120 - 300mm. Overlaying a concrete road inevitably raises a problem of "reflective cracking" due to the presence of discontinuities (joints) or defects (cracks) in the concrete pavement. To prevent reflection cracking, various types of interface and various techniques such as saw-cut and seal or slot sealing have been used with varying degrees of success.

Other rehabilitation/strengthening techniques include:

- Full depth reconstruction: This repair technique is used to permanently restore cracked or disintegrated areas of a concrete slab, or to completely replace an entire shattered or deteriorated slab [192];

- Crack and Seat with overlay technique: Potter and Mercer [194] explained that the philosophy behind Crack and Seat (C&S) is to reduce the length of concrete between joints. If the joint spacing in the concrete is reduced, the horizontal strains in the asphalt overlay resulting from thermally induced movement at those joints should be distributed more evenly throughout the length of the pavement and are therefore less likely to cause transverse cracks in the surface of the overlay;
- Saw-Cut Crack And Seat (ScC&S): A technique, as described by Langdale [195], which has been developed for reinforced concrete pavements.

As a last resort the pavement may be *rubblised* [196] and used as a foundation for new construction or *recycled* [197].

## 5.4 Rejuvenators

As mentioned above, an alternative approach to removing the surface is to improve the properties of the existing aged bitumen by applying a rejuvenating agent to the surface which is designed to soften the bitumen. Rejuvenators are also often included in both hot-mix and cold-mix recycling processes.

Rejuvenators are intended to modify the binder so that its ductile and binding properties are restored. They may also seal the surface to help prevent loss of stone and the more volatile components of the binder. Generally when a rejuvenator is sprayed onto an existing surface it is effective to a depth of 5 or 10 mm of the surfacing. It is claimed that the life of the surface can be increased by approximately five years and after that time an additional treatment can be applied for a further increase in life. This may be particularly useful where a major maintenance is planned for another part of the highway (either a structure or an adjacent length of pavement perhaps) where treatments are planned for a few years time. By prolonging the surface life with a relatively quick and non-disruptive rejuvenation treatment, structural maintenance of the rejuvenated section can be postponed and carried out with other major works at a later date, thus minimising overall disruption to the public.

The following liquids and admixtures can act as rejuvenators, because of their known action in softening the binder:

- A soft bitumen;
- A cut-back oil, such as a creosote type liquid or a flux oil, such as a diesel type liquid;
- Emulsions;
- Proprietary liquids.

Examples of the application of rejuvenators can be found in the SILVIA report by Sanders [73].

Although the use of rejuvenators has been reasonably widespread for twenty or more years there are relatively few documented case studies that provide convincing evidence of the effects of rejuvenators on pavement performance. One of the reasons for this problem is that there are a large number of rejuvenators and the combinations of (inter alia) traffic, binder type, asphalt mixture type and environmental conditions make it difficult to determine reliable guidelines for use.

There seems little doubt that whereas rejuvenators are effective in some circumstances, for design purposes more work is required to establish the products that are effective in different circumstances. With respect to Health and Safety and environmental impact, the use of neat rejuvenating oils should perhaps be avoided due to the risk of exposure of workers to volatile organic components (VOCs).

## 5.5 Cleaning methods

During its service life, the pores of porous asphalt tend to be clogged by dirt, dust and general detritus arising from the wear of the surface and vehicle tyres. It has also been reported by Bendtsen and Larsen [74], based on observations in the Netherlands and in Denmark, that tyres can transport dirt to porous pavements from adjacent pavements. Furthermore, surfaces are compacted over time by traffic which also leads to a reduction in void content. With the reduction in pore volume, some of the noise reduction advantages and drainage functions of porous surfaces will gradually disappear.

The clogging of the pores starts in the upper part of the surface. Therefore it is important to initiate any cleaning of the surface before the pores become totally clogged. If this situation is reached, then it will be very difficult to get the porosity of the layer back.

On high-speed lanes, the vehicle tyres themselves produce a cleaning effect; this has been observed to occur even more effectively when vehicles travel at speed during heavy rainfall due to the effects that occur at the leading and trailing edges of the tyre contact patch [10]. The faster the speed of the traffic, the greater the cleaning effects, so the problem of clogging is therefore more serious on low speed lanes, or minor roads and streets in the cities.

Special cleaning equipment has been developed to help reduce detritus build-up in porous road surfaces. An example is shown in Figure 5.3. The equipment uses a combination of power washing and suction to remove the detritus [75, 39]. A Japanese study [76] concluded that the best cleaning process for porous surfaces is a combination of water jet blasting (spraying the surface with water under high pressure), dirty water suction and vibrations transmitted by a "plane of water" in between the water blasting and the suction. Long periods of dry weather can mean that these cleaning processes are less effective; in these cases it is recommended that pre-wetting of the surface be carried out. This will improve the effectiveness of the cleaning procedures.



Figure 5.3: Example of a cleaning system for porous road surfaces

The latest development in Japan is a cleaning machine which relies on the ejection of high-pressure air (i.e. no water) and operating at 10 km/h or even 20 km/h (during the night-time). The work on this system has indicated that the most cost-effective usage is achieved by running a single cleaning operation *every week*, beginning one week after the surface is laid. This is estimated to cost approximately €4/m<sup>2</sup> of paved area per year; it is estimated that this cost will reduce to €2/m<sup>2</sup> per year with the next version of the cleaning machine [69].

In terms purely of the cleaning, i.e. not taking into account cost-effectiveness, local roads surfaced with PA may need to be cleaned once or twice a year. Due to the cleaning action of the traffic, high-speed roads may require less frequent cleaning. A maintenance study proposed for porous surfaces by OECD [77] suggested initial cleaning two years after laying and then periodic cleaning every two years.

It is noted that unless cleaning is carried out as part of regular scheduled maintenance, it may be preferable to assess the degree of clogging of the porous surfaces beforehand. The drainage capacity or permeability of the road surface can be measured using a Becker drainometer (based on water flow) or an air-drainometer such as that developed at DWW in the Netherlands [78].

A Becker drainometer uses a column of water which flows through a cylinder into the road surface. The approach has a number of disadvantages, namely the use of water, manual operation (which makes the measurements more time consuming) and the localised nature of the measurements (due to the small diameter of the cylinder). To determine the degree of clogging over a wide area therefore requires a large number of measurements. On pavements with a coarse surface texture, the accuracy of the results is affected by water leaking through the gap between the flange of the cylinder and the pavement.

The air drainometer developed by Sanches [78] overcomes some of these problems. The apparatus blows air through a 400 mm diameter measurement flange pressed onto the road surface at a flow rate of 1.5 m<sup>3</sup>/min.

Both methods allow the degree of clogging and the void content of porous road surfaces to be determined. Clogging classes have been determined as shown in Table 5.1.



Table 5.1: Clogging classes for porous road surfaces [78]

Degree of clogging	Air pressure (mbar) (using air-drainometer)	Void content (%)	Flow time (sec) (using Becker test)
Clean open pores	30-180	16-23	< 25
Slightly blocked pores	180-300	13-16	25-50
Moderate blocked pores	300-700	11-13	50-75
Almost blocked pores	>700	<11	>75

A study of clogging on porous road surfaces carried out in the Netherlands [79] using the Becker apparatus showed that the permeability of PAC in the slow lane decrease during the first years after construction until it reaches a more constant level. The initial Becker flow time of 10 seconds increases by the order of 10-15 seconds after two years. It is assumed that the pressure fluctuations caused by passing vehicle tyres prevents the surface from clogging further; the level of clogging is dependent upon the traffic intensity and speed. Measurements on the hard shoulder indicate a steady loss of permeability by a Becker flow time of the order of 10 seconds per year.

Measurements have also been carried out in the Netherlands to determine the effects of wet cleaning of clogged PAC surfaces on permeability using an air drainometer [80]. Evaluation of the results shows that heavily polluted PAC surfaces cannot be cleaned with the presently available wet cleaning methods. Only with frequent cleaning from an early stage will the permeability of the road be maintained.

The conclusion from the Dutch studies is that on main highways and motorways, the cleaning of PAC surfaces in the driving lanes is unnecessary. Only the hard shoulder requires cleaning to maintain the draining capacity of the driving lanes. The cleaning interval will depend on the degree of clogging but once or twice a year is considered sufficient. This is broadly in line with the OECD recommendations.

## 5.6 Winter maintenance operations

Winter maintenance generally refers to the treatments needed to prevent ice and bonded snow formation during cold periods in the winter. This may be prevented by timely applications of a chemical freezing-point depressant [81]. The use of such materials does, however, need careful management as there are negative effects that relate to the corrosion caused by de-icing salts on vehicles, structures and road surface components. In addition, the use of these materials can have a negative effect on the environment and care is needed to avoid, for example, the pollution of nearby watercourses. In extreme conditions, the use of equipment such as snow ploughs (Figure 5.4) may be required.



Figure 5.4: Example of a snow plough

The critical factor in winter maintenance is determining the right time and the right place for applying the de-icing materials such as gritting with salt. Research showed that preventive gritting may reduce the need to use thawing agents and prevents icy roads [82]. Therefore weather forecast and ice-predicting systems play an important role to foresee the right winter maintenance operations. For example, on Austrian roads 350 Road Ice Prediction Systems are installed. Information from the monitoring stations is transmitted by lines leased to the road authorities. Generally the stations are set up at the coldest points of the roads and bridges. The determination of the location of new stations takes place through thermal mapping and the experience of the road management authority.

With regards to undertaking winter maintenance, the following data is measured/monitored in Austria [83]:

- Air temperature (°C);
- Surface temperature (°C);
- Relative humidity (%);
- Precipitation (rain, snow);
- Road condition (dry, moisture);
- Freezing temperature after the spreading of de-icing material (°C);
- Wind conditions (direction/speed) – only in limited cases;
- Dew point (°C) – only in limited cases;
- Air pressure (hPa) – only in limited cases.

On motorways de-icing materials are used. The application of grit on motorways is intended only in exceptional cases. Federal highways, country roads and municipal roads can be covered either with de-icing materials or grit. A mixture from both strewing means

is common (e.g. sodium chloride: grit - mixing proportion - 1:10). In many areas a prohibition in the use of de-icing salts exists because of environmental protection reasons. In Vienna a salt spreading prohibition has existed since 1982. Excluded from it are motorways, bridges and staircases. Figure 5.5 shows an example of a salt spreader.



Figure 5.5: Example of a salt spreader as used in Austria

Sodium chloride and calcium chloride are the most common snow and ice removal material. In exceptional cases also potassium carbonate is used. The spreading material can be used from 5 to 40 g/m<sup>2</sup> (de-icing material) or 40 to 320 g/m<sup>2</sup> (grit). On the average 15 g/m<sup>2</sup> (de-icing material) or 120 g/m<sup>2</sup> (grit) are common. The spreading width from 2 to 8 m is possible.

In Vienna the grit is collected, washed and used again in the next winter period. Table 5.2 shows some prices of spreading material used in Austria.

Table 5.2: Price examples of spreading material in Austria [83]

De-icing material	Cost (€ per ton)
Grit	12.21
Sodium chloride	71.95
Calcium chloride	222.92
Potassium carbonate	545.05

In cases where there are significant amounts of snow, special traffic restrictions can be ordered by the police. For some roads at greater altitudes, there may be a mandatory

requirement to use winter tires or snow-chains. Some exposed roads in the Alpine region are usually closed in winter.

Winter maintenance on some low-noise road surfaces can give rise to additional problems. However, it can generally be stated that treatments for dense asphalt low-noise pavements or non-porous concrete surfaces will not need to be any different from those used on conventional surfaces.

Many countries have reported special problems concerning winter road maintenance on porous asphalt concrete layers [84, 85, 86]. The special conditions and characteristics reported are:

- The thermal conductivity is lower which results in more rapid and deep temperature drop during autumn and winter. Compared with dense pavements porous asphalt concrete is about 1°C colder. This leads to a somewhat longer persistence of freezing conditions on the road surface and, as a result, to a higher consumption of road salt;
- The thermal sensitivity can lead to earlier formation of ice and frost. The time salt stays on the surface is very short as a result of the high void content and rapid drainage. The surface can stay wet for longer and condensation can take place due to moisture in the voids. There is also no splash effect (horizontal movement by traffic) of salt brine;
- In slushy conditions the performance of porous asphalt concrete is slightly poorer as the slush is first pressed into the pores by the snow plough but then wells back up again after a short time. This necessitates another salting pass to avoid freezing again (and leads again to a higher consumption of road salt).

This means that porous asphalt concrete layers are generally somewhat less skid-resistant and require more extensive de-icing measures than conventional dense asphalt layers. Due to its self-draining properties porous asphalt concrete has to be treated with salt more frequently and with higher application rates [87]. The importance of using suitable snow removal equipment has also been reported. It is especially important not to use very aggressive snowploughs as they can damage the porous surface.

Detailed inquiries [88] in Austria showed that preventive salting of the porous road surface may not be effective as precipitation carries the material into the pores. Once there, however, it may still counteract the freezing of the pavement. It will therefore be better to use several applications of smaller quantities of salt than using a single pass with a large quantity. This means that more accurate continuous monitoring will be necessary.

The most dangerous road condition, regardless of the pavement system in place, is rain falling onto a road surface of sub-zero temperature. If winter maintenance services are not started at the right time, the formation of icy stretches on the road is inevitable. Getting the icy layer to thaw is much more difficult on porous pavements than it is on dense pavements and requires substantially larger consumption of road salt (in the order of 25-50%).

With regard to winter maintenance techniques careful consideration should be given to some of the restrictions in the use of porous surfaces:

- The application of grit in winter maintenance is not possible with porous pavements as this would result in clogging of the pores. Therefore porous asphalt concrete pavements are eligible only for sections destined exclusively for treatment with road salt;
- Porous asphalt concrete pavements may not be useful on sections frequently travelled by vehicles with snow chains or studded tyres as the forces acting on the pavement when vehicles are started may cause ravelling and thus damage of the pavement texture.

## 5.7 Recycling of surface courses

The different processes available for recycling of road planings are summarised in Table 5.3 and described in more detail in the following sections.

Table 5.3: Available processes for road materials recycling [89]

Location	Hot	Cold
In-situ (Shallow) (Surface course maintenance to a depth of around 20 mm)	Heater / scarification, remix and/or repave	Retread
In-situ (Deep) (Maintenance to a depth up to 350 mm)	N/A	Deep in situ
Off-site	Central plant hot recycling (CPHR)	Central plant cold recycling (CPCR)

An in-situ recycling process involves a train of machines planing out, then immediately processing the material and relaying it without removing it from site. In-situ recycling is usually preferred because it is less costly (with the elimination of costs associated with the stockpiling, handling, maintaining an inventory and long-distance hauling of the reclaimed material) and because it causes less disruption to the traffic.

An off-site recycling process involves processing the material in a central plant, located far away from the road surface.

### 5.7.1 In-situ hot mix processes – General description

Hot in-place recycling (HIPR) is defined as a process to correct asphalt pavement surface distress by softening the existing surface with heat, mechanically removing the pavement surface, mixing the reclaimed asphalt with a recycling agent, possibly adding virgin asphalt and/or aggregate, and re-laying. A train of machines, working in succession, performs the recycling. The scale and the cost of the equipment make this process convenient only for major roads. To use this technique with confidence in the quality of the

finished product, long, homogenous paving lengths are needed, which is normally only the case on major roads.

The HIPR can either be:

- A single-pass operation, with recombination of restored pavement with or without virgin material;
- A two-pass procedure, with laying of a new surface course after an interim period

The American Asphalt Recycling and Reclaiming Association (ARRA) recognise three basic processes, sometimes collectively referred to as surface recycling [90]. In all three of the following processes, bitumen emulsions are typically used to rejuvenate the bitumen and provide a higher binder content.

- *Heater-scarification*: The process consists of heating, scarifying and rejuvenating the old material before levelling, reprofiling and compacting the recycled layer. The typical depth removed is about 25 mm;
- *Repave*: The process consists of heating and scarifying the road surface; mixing and laying the removed material before overlaying that with new material. The depth treated varies from 25 mm up to 50 mm. An English contractor, for example, adopts this technique, that consists of:
  - The existing road surface is heated up to 150 °C and scarified to a depth of 30 mm using a two-stage scarifier with spring loaded tines to avoid damage to the street furniture;
  - Next, an oscillating, floating screed reprofiles and corrects levels for the required crown or crossfall. The recycled material is used as the regulating course [91];
  - The process is completed by the immediate application of a 25 mm asphalt surface course of hot rolled asphalt with 20 mm pre-coated chippings, high stone content hot rolled asphalt or a proprietary thin surfacing. The heat from the Repave machine welds the new material to the remaining surface and so removes the need for a bond coat.
- *Remix*: An adaptation of the above process, with a small mixing unit joined to the train. In that machine, the recovered material is blended with some fresh mixed material. The recycled mixture, containing as much as 80% of reclaimed asphalt material, is placed evenly on the heated surface to form the replacing recycled surface course.

The HIPR is typically a shallow superficial restoring process, although in a few cases it has been performed to a depth of 75 mm [90, 92].

### 5.7.2 In-situ cold mix processes – General description

The process involves pulverising an existing pavement, sizing the reclaimed asphalt pavement (RAP), incorporating additives (such as bitumen emulsion and hydrated lime,

bitumen emulsion and cement, or polymer-modified emulsions) before placing and compacting the mixture. The layer is then overlaid with new material [92].

- *Shallow or Retread:* The process is carried out at depths of 25 mm to 75 mm. The process is well established, having been first adopted during World War 2. It consists of scarifying and reshaping the surface, with virgin aggregate added or excess chipping removed if either action is required as part of re-profiling the road. The bitumen is added by spraying it and harrowing the layer. After compaction, the surface is sealed by surface dressing in order to close any surface voids and to provide a good texture. The process is typically adopted for lightly trafficked roads [93];
- *Deep:* Can either be a full width process (normally 125 mm to 330 mm in depth) or a haunch repair process (typically 150 mm to 300 mm in depth).

### 5.7.3 Off-site processes – General description

The recovered material is mixed with virgin aggregates in typical mixing blends (RAP: virgin aggregate) of 10:90, 30:70, typically to a maximum proportion of 50:50. Some specifications do not allow the use of hot recycled mixtures for surface courses with any proportion of RAP permitted whilst, in other cases, mixtures containing RAP have been used with success. The SUPERPAVE system is also being applied to material from hot plant recycling [92].

- *Off site cold planning:* A process where asphalt layers are removed by scarification to a specific depth and the surface restored to desired grade and slope, free of bumps, ruts, etc. This process may be used for roughening or texturing the pavement to restore skid resistance properties. The reclaimed pavement is loaded into trucks and hauled to a stockpiling site for future utilisation.

### 5.7.4 Recycling of specific surface types – thin layers

Because of their speed and the immediate re-utilisation of the old material, the in situ processes could be considered good candidates for the recycling of thin surfacings by adaptation from shallow surface course recycling procedures.

Both hot and cold processes have been developed for a superficial scarification of the pavement with a minimum nominal depth of 20 mm to 25 mm (Retread and the HIPR processes). Nevertheless, these depths are consistent with that of thin surfacing layers.

Generally speaking, when the surface distress results in the need to resurface due to the characteristics of the aggregate in the material, the hot in situ processes are preferred. They degrade the recyclable aggregates less than the cold processes, in which the crushing of the pavement layer causes breakage of stones and results in the production of fines. An adjustment to the grading envelope by adding new aggregate is not usually required with the hot processes, a process that may require an in-depth analysis of every batch recovered. However, the cold in situ solution can be adopted successfully for asphalt materials where a high fines content does not cause problems.

However, when the defect is a loss of skid resistance following polishing of the aggregate, the recycling procedure usually needs to include an overlay of asphalt with high PSV

aggregate. Nevertheless, the otherwise unsuitable highly polished material will still be reused instead of being sent to landfill.

### **5.7.5 Recycling of specific surface types – porous asphalt**

Recycling old asphalt material is very common in many countries. When the material comes from old porous asphalt layers there are some special questions to consider:

- The penetration of the binder in the old material can be very low down to values of pen 10. There could be problems regarding blending such a hard bitumen with the new binder;
- If a modified binder is used in the old porous asphalt there could be compatibility questions about the use of the modified binder with the newly added binder;
- Through the pollution of the old porous asphalt, which can consist of an accumulation of organic as well as inorganic materials (such as heavy metals) environmental limitations can be exceeded.

Despite these problems there are reports from several countries about recycling of old porous asphalt. Adding of low percentages in new asphalt has worked well [39].

Further information on the recycling of surfaces is included in the SILVIA Project Report by Sanders [73].



## 6 Prospects for the further development of low-noise surfaces

The different types of low noise surfaces and their acoustic benefits have been described in the preceding chapters. This chapter is concerned with describing how these surface types may be developed further in the future to provide additional noise reduction benefits. The chapter begins by describing the different types of experimental surfaces that are currently being evaluated. The chapter includes comments on how both the use of materials and improvements in construction practices can help to ensure a good standard of noise reduction and concludes by reporting the results of measurements carried out on a range of both production and prototype low noise surfaces carried out as part of SILVIA.

### 6.1 Experimental surfaces and surfaces currently under development

This section provides a short overview of new/recent developments and concepts in low-noise road surfaces that have not yet been widely accepted for general use.

#### 6.1.1 Double-layer porous asphalt

##### 6.1.1.1 Definition, overview and background

Double-layer porous asphalt (DPAC) was developed in The Netherlands in the early 1990s as a development of single-layer porous asphalt (PA) and offers improved noise reduction compared to PA [94]. DPAC consists of two layers of porous asphalt: a coarse, open graded bottom layer and a finer textured top layer. The upper layer acts as a sieve to stop larger particles of detritus from reaching the larger voids in the lower layer. In addition, as a result of the smaller stones used in the upper layer, tyre vibrations and hence noise are also reduced when compared with surfaces with coarser aggregates. These two characteristics provide a low noise surface that also resists some of the clogging found on single layer porous surfaces. As a result, DPAC surfaces are appropriate for used in urban areas as well as on motorways. Optimisation of double-layer porous asphalt is currently being carried out as part of the Dutch IPG (Innovatie Programma Geluid) road traffic noise reduction programme [95, 96] (see Section 6.1.1.5).

##### 6.1.1.2 Material specifications

The coarse, open graded bottom layer generally has a grading between 11-16 mm, while the upper layer has a finer grading. Early sections used 4-8 mm aggregate for this upper layer, but more recently 3-6 mm aggregate has also been used. Test sections have also been constructed in the Netherlands with a 2-4 mm graded upper layer but these were not very successful: The initial acoustical performance of this type of two-layer porous asphalt was excellent. However, after a few months the noise reduction reduced due to clogging of the top layer since the sizes of the pores were too small. Furthermore, it appeared that this type of mix was rather vulnerable to ravelling. As a result of these experiences, the two-layer porous asphalt with a top layer of 3/6 mm was developed.

A modified bitumen is used in both asphalt layers. The thickness of the bottom layer is approximately 45 mm, with the top layer being approximately 25 mm depending upon the aggregate size.

***Aggregate properties:***

In the Netherlands, it is proposed that the Polished Stone Value (PSV) of the aggregate in the upper layer should be at least 53.

**6.1.1.3 Functional properties**

Because of its open structure, DPAC minimises splash and spray effects, but for a good run off it is important that there is sufficient cross fall and sufficient drainage capacity. In urban areas, this requires the construction of special drainage systems.

**6.1.1.4 Advantages and disadvantages of the surface type**

The following advantages and disadvantages are associated with double layer porous asphalt:

***Advantages:***

The high noise reduction performance can reduce the need for other mitigation measures such as noise barriers or insulation at roadside properties.

DPAC is suitable for use in urban areas as well as on motorways.

Because of its open structure, DPAC minimises splash and spray, increasing the level comfort and safety for road users. The run-off from DPAC surfaces is cleaner than the run-off from dense asphalt concrete, due to the filtering nature of the surface, and this can be advantageous in water-collection areas.

***Disadvantages***

There are however, problems with the durability of DPAC. For high life expectancy, care must be taken in selecting where the surface is laid, e.g. the surface should not be used on sharp bends or at crossings (where the increased frequency of vehicle accelerations and decelerations and increased steering leads to increases in friction thereby increasing the likelihood of rutting) or locations where high pollution levels are expected.

DPAC pavements are generally relatively costly as a result of the high construction and maintenance costs.

**6.1.1.5 Typical performance data**

Table 6.1 summarises the acoustic performance data for DPAC surfaces collated within the SILVIA project [43].

It should be noted that there was insufficient data from surfaces at a single site or of a similar aggregate size to allow for any estimation a typical acoustic lifetime for the surface type. Consequently, the data for all DPAC surfaces, independent of aggregate size, has been averaged to determine a mean performance over the surfaces available. Data on the age of the surfaces and the aggregate sizes used in the upper layer is also collated in the table.

Table 6.1: Summary of performance data for two-layer porous asphalt concrete (DPAC) surfaces

Speed	No. of sites	Surface Age, yrs		SPB Level, dB(A)			Aggregate size (upper layer), mm		
		Average	Range	Average	Min	Max	Average	Min	Max
<i>Passenger Cars</i>									
50 km/h	18	2.4	0.1 - 4.9	66.7	62.9	70.4	6.0	5.0	8.0
80 km/h	4	1.0	0.2 - 1.4	69.6	68.3	70.9	7.0	7.0	7.0
110 km/h	4	0.25	0 - 0.6	78.0	76.5	80.0	7.3	5.0	11.0
<i>Dual-axle heavy vehicles</i>									
85 km/h	4	0.25	0 - 0.6	81.8	79.7	83.8	7.3	5.0	11.0
<i>Multi-axle heavy vehicles</i>									
85 km/h	4	0.25	0 - 0.6	82.5	80.3	86.6	7.3	5.0	11.0

In the 1990s a Danish experiment showed that a single-layer porous pavement with a rather small maximum aggregate size of 8 mm maintained a noise reduction of 3-4 dB during the whole lifetime of the pavement [97]. The reduction was measured by the SPB method relative to a dense asphalt concrete with a maximum aggregate size of 12 mm. This experiment was carried out on a highway where the speed limit was 80 km/h. The same type of porous pavement was tested on an urban road with a speed limit of 50 km/h. Here an initial noise reduction of 3 dB disappeared after only 2 years due to clogging of the pores of the pavement. The results are presented in Figure 6.1.

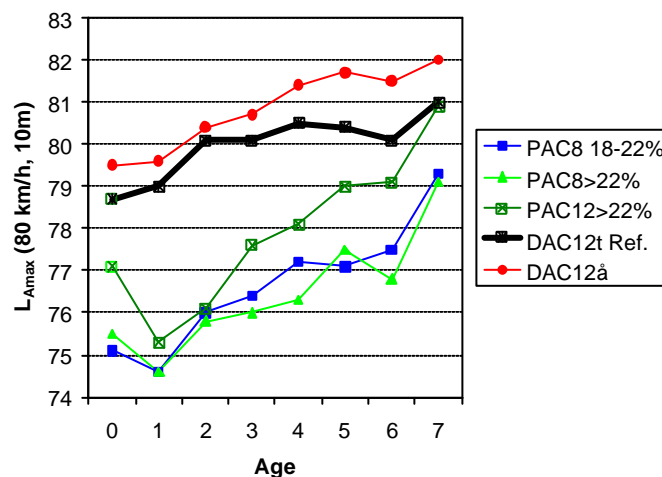

Figure 6.1: Noise level on test sections at a highway, expressed as  $L_{AE}$  values, at 10 m distance in dB, at 80 km/h, for an eight-year period. DA: Single-layer porous asphalt; AB: Dense asphalt concrete [97]

There seems to be a tendency that porous pavements on highways keep the porous structures open during their lifetime. This is explained by a self cleaning mechanism where the tires in rainy periods press water down in the pores of the pavement under high pressure. Whereas on low speed roads the water pressure is not high enough to ensure a continuous cleaning effect of the pavements, and therefore they tend to clog and by that loose their noise reduction.

Two layer porous pavements have been tested over a long period in the Danish so called Øster Søgade experiment [98]. The objective of the Danish project (which started in 1998) was to develop, optimize, and test noise-reducing pavements for urban roads with a long-term noise-reducing capacity, based on the Dutch experience with double-layer porous asphalt. Noise and permeability measurements were made using test sections on a two-lane urban road with various double-layer porous asphalt pavements with a high built-in air void of 22-26%. The maximum aggregate size of the top layers was 5 and 8 mm. As a reference a dense asphalt concrete pavement with a maximum aggregate size of 8 mm was constructed at the test site at the same time as the porous pavements. A reference surface with 11 or 16 mm aggregate will increase the noise reductions achieved by around 1-2 dB. Table 6.2 summaries the results from the study.

Table 6.2: Noise reduction for mixed traffic (SPB Index) and for passenger cars ( $L_{veh, p}$ ) relative to the reference pavement (DAC8) of the same age. [98]

Two layer porous pavement with 8 mm aggregate	Noise reduction [dB]	
	Mixed traffic	Passenger cars
Year 5 (2004)	1.7	2.0
Year 4 (2003)	2.8	3.1
Year 3 (2002)	2.4	4.1
Year 2 (2001)	2.7	3.9
Year 1 (2000)	4.6	5.3
Year 0 (1999)	4.5	4.6

As part of the Dutch IPG programme [95, 96], extensive investigations are being performed into the performance of two-layer porous asphalt. This has included the laying of a large number of test sections which have been monitored extensively [99]. Some of the results from these monitoring tests are shown in Figure 6.2.

Further details of the IPG programme on TLPA, which includes an examination of cost-effectiveness and lifetime performance can be found in the papers by Hofman *et al.* [99] and Goubert *et al.* [100].

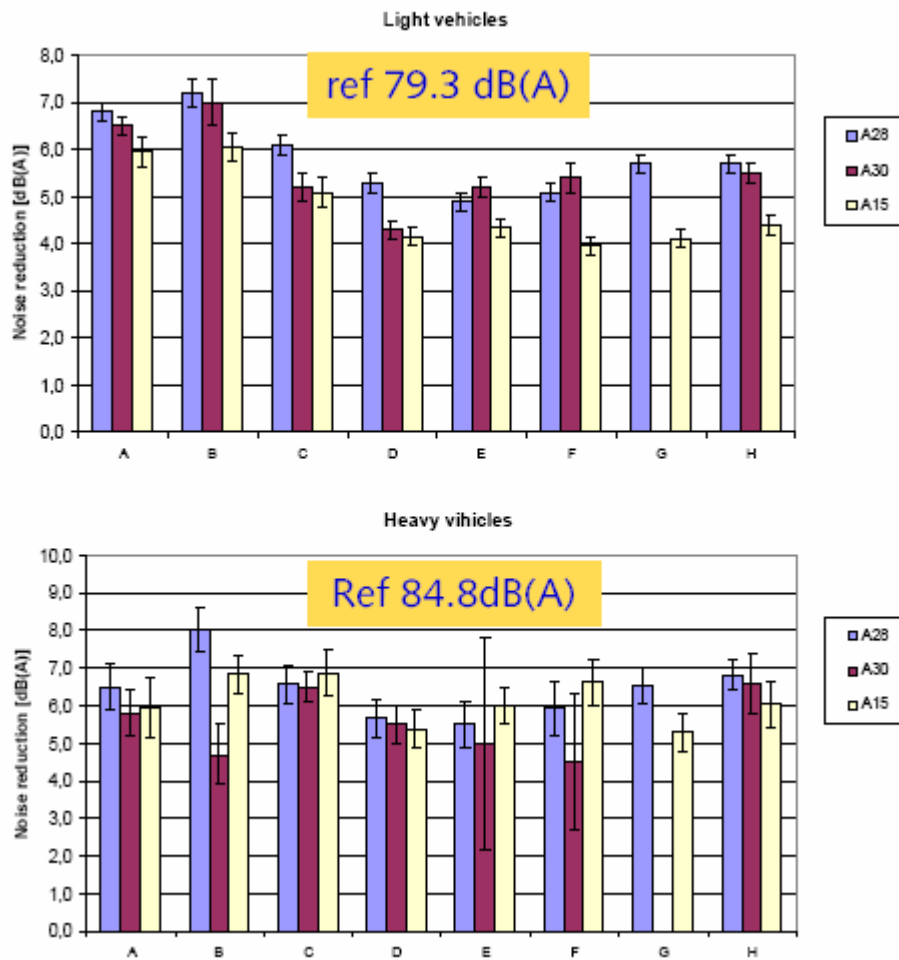

Figure 6.2: Noise reductions on new two-layer porous asphalt sections as measured during the Dutch IPG programme. Measurements based on SPB measurements at 5 m height; light vehicle speed = 110 km/h, heavy vehicle speed = 85 km/h. Surfaces A and B have a 2/6 upper layer, C-H have a 4/8 upper layer. [99]

### 6.1.2 Poro-elastic surfaces

A poro-elastic road surface (PERS) is a wearing course that has a very high content of interconnecting voids, so as to facilitate the passage of air and water through it, but also possesses some elasticity due to the use of rubber granules or fibres (e.g. scrap tyres, “new” rubber or other elastomeric products) as a main aggregate, sometimes supplemented by sand, stones or other friction-enhancing aggregates.

PERS surfaces are generally designed with an air void content of at least 20% by volume and with a rubber content of at least 20% by weight. In trials of poro-elastic surfaces reported to date, a polyurethane binder is used to hold the mix together with the binder content ranging from 5-15% by weight. Additional binder is also required to fix the poro-elastic material onto the existing road base course. This may be the same binder as that used to hold the mix together, but epoxy resins have also been used in the past for this purpose.

Details on the performance of poro-elastic surfaces are given in Section 6.4.2.

### 6.1.3 Porous cement concrete

Although mentioned earlier in this document, porous cement concrete (PCC) surfaces are still at a relatively early stage in development. Porous concrete has an open, self-draining structure similar to porous asphalt, however in this case the binder is cement mortar rather than asphalt.

In recent years, experiments have been conducted in several countries (Germany, the Netherlands, France and the USA) using PCC pavements to reduce traffic noise, e.g. [10]. It is suggested that the problems of clogging that are traditionally associated with porous surfaces will be less pronounced in porous cement concrete. However, this has yet to be shown to be the case experimentally. Nevertheless, it has been reported, e.g. [101], that void contents of 25-30% are possible with PCC without any structural problems which suggests that this type of surface would be less prone to clogging than conventional porous asphalt pavements where a void content of greater than 20% is not presently possible.

Trials undertaken in the Netherlands using PCC pavements have demonstrated that a similar noise reduction to porous asphalt can be achieved if the accessible porosity of the cement concrete is at least 25%. However, one problem associated with the use of cement concrete pavements is an unfavourable megatexture which leads to driver discomfort and an increase in noise. Currently, PCC is approximately 40% more expensive than dense cement concrete.

A double-layer PCC is under development in the USA [10]. The concept is similar to that of double-layer porous asphalt. The first results from these tests are described as promising.

Although there may be some reduction in clogging on PCC, the problems of winter maintenance described earlier for PA surfaces also apply to PCC surfaces.

Studies in Germany have shown that compared to burlap-texture concrete and SMA, the surface gave a noise reduction of the order of 5 dB(A). However, after two years, the open porous concrete was no longer providing satisfactory traction.

Table 6.3 summarises the acoustic performance data for porous cement concrete surfaces collated within the SILVIA project [43]. It should be noted that there was insufficient data from surfaces at a single site or to allow for any estimation of a typical acoustic lifetime for the surface type. Consequently, the data for all porous cement concrete surfaces, has been averaged to determine a mean performance over the surfaces available. Data on the age of the surfaces and the aggregates used is also collated in the table.

Table 6.3: Summary of performance data for porous cement concrete (PCC) surfaces

Speed	No. of sites	Surface age, yrs		SPB Levels, dB(A)			Aggregate size, mm		
		Average	Range	Average	Min	Max	Average	Min	Max
<i>Passenger Cars</i>									
80 km/h	2	4.1	0.2 - 8.0	74.5	74.0	74.9	7.0	7.0	7.0
110 km/h	4	1.6	1.2 - 2.0	77.1	75.8	78.6	8.0	8.0	8.0
<i>Dual-axle heavy vehicles</i>									
85 km/h	3	1.5	1.2 - 2.0	80.1	78.4	81.5	----- Unknown -----		
<i>Multi-axle heavy vehicles</i>									
85 km/h	4	1.6	1.2 - 2.0	83.5	79.1	90.9	8.0	8.0	8.0

#### 6.1.4 Euphonic pavements

These surfaces consist of a wearing course of 40-60 mm of porous asphalt which is laid on a continuously reinforced concrete slab which includes Helmholtz resonators<sup>10</sup> each of about 500 cm<sup>3</sup>. This surface can be considered to be similar to a double-layer porous surface. The resonators set in the sub-base will absorb acoustic energy at their resonant frequencies.

Small-scale experiments have shown that the combination of resonators and porous layers absorbing sound over widely different frequency ranges can result in a rather large absorption coefficient throughout the relevant frequency range. In addition to reducing the frequency components comprising tyre/road noise, the low frequency components of vehicle noise can also be addressed. This could be particularly advantageous in urban conditions where engine and exhaust noise tend to dominate. The drainage capabilities of such a porous surface are likely to be enhanced since water can flow unimpeded through the cavities to the drainage system. Consequently, clogging is less likely to be a problem.

Trials of euphonic pavements have been also undertaken in Italy as part of the SIRUUS project, although no results have been published to date. Trials on similar types of surface, known as *The Rollable Road* and *Very Silent Noise Module*, were also undertaken as part of the Dutch "Roads To The Future" project (see Section 6.1.5).

#### 6.1.5 Modular pavements

A series of modular pavements have been trialled as part of the Dutch Roads to the Future Scheme. Several of the pavements are undergoing further trials as part of the Dutch IPG national noise innovation programme.

<sup>10</sup> A Helmholtz resonator is essentially a rigid cavity of a given volume which is connected to the outside air by a narrow neck or slit. Sound waves arriving at the neck will cause the cavity to resonate at a frequency that is dependent on the geometry of both the neck and cavity.

The concept behind a modular surface is that the surface consists of different layers, potentially prefabricated, with each layer having an individual purpose, e.g. noise reduction, water permeability, etc. The pavements tested were as follows:

- *Modieslab*: Prefabricated two-layer porous concrete slabs on piles, offering a predicted noise reduction of 7 dB(A) relative to the Dutch dense asphalt concrete reference surface;
- *The Rollable Road*: Helmholtz resonators in cement concrete with two thin, rollable porous asphalt top layers, offering a predicted noise reduction of 10 dB(A) relative to the Dutch dense asphalt concrete reference surface;
- *The Very Silent Noise Module*: Helmholtz resonators in cement concrete with a very thin, quiet asphalt top layer, offering a predicted noise reduction of 13 dB(A) relative to the Dutch dense asphalt concrete reference surface;
- *Rollpave* (formerly *The Adhesive Road*): A rollable porous asphalt with an adhesive, geostatic support layer, offering a predicted noise reduction of 6 dB(A) relative to the Dutch dense asphalt concrete reference surface.

Figure 6.3 shows examples of the Modieslab, Rollable Road and Rollpave surfaces.

Full-scale in-situ measurements on trial sections indicated much lower initial noise reductions than predicted, of the order of 5-7 dB(A), relative to a dense asphalt concrete reference surface. The Modieslab and Rollpave surfaces are undergoing further trials as part of the Dutch IPG national noise innovation programme.



Figure 6.3: Examples of modular road surfaces tested during Dutch "Roads To The Future" project

## 6.2 Optimising the acoustic performance of low-noise surfaces

In addition to the development of new innovative road surfaces to achieve improvements in acoustic performance, a great deal can be done to ensure that existing surfaces provide their optimum acoustic performance. This section of the Manual describes how material specification and construction practices play an important part in ensuring that surfaces designed specifically to reduce noise levels achieve their potential acoustic performance in practice.



## 6.2.1 Changing material properties

As noted in Section 3.3.1.1, texture wavelengths that fall within the megatexture range (50 – 500 mm) are important for both controlling noise performance and providing sufficient skidding resistance. It is therefore important that megatexture be carefully controlled by using small-scale aggregates, although the required durability of the surface must be taken into account (e.g. surfaces with small scale aggregates have a low resistance to wear from studded tyres).

A balanced ratio between macrotexture and microtexture is necessary to achieve low noise *concrete* surfaces. It is possible to specify the influence:

- At wavelengths ranging between 10 mm and 500 mm, the rolling noise increases notably as the amplitude in this range increases. The main noise mechanism is related to tyre tread impacts. This tends to give rise to noise at frequencies below 1000 Hz. For this reason, the texture must have the lowest possible roughness over this range;
- At wavelengths ranging between roughly 0.5 mm and 10 mm, the rolling noise decreases with the amplitude, particularly at frequencies > 1000 Hz. In this case the texture provides improved ventilation of the tyre profile which helps to reduce the generation of aerodynamic noise. Average texture depths of 0.4 mm to 0.8 mm have proven favourable for noise reduction of car tyres and at least 1.0 mm for heavy vehicle tyres. EACC need to be mixed with small-scale gap graded aggregate size maximum 8 mm with good angle particle shape as less oversize and undersize as possible.

The sound absorption properties of porous pavements can be tuned to the typical spectrum of the traffic operating on the road in question. Increasing the porosity of the surface reduces noise generated by air pumping and increases the acoustic absorption and by consequence, reduces the horn effect. Further information on the effects of porosity is given in Section 3.3.1.2. Increasing the layer thickness or the void volume will tend to reduce the frequency where the main sound-absorbing effects take place. In theory, a greater degree of tuning can be achieved with double-layer porous surfaces rather than single-layer surfaces.

As noted in Section 5.1.1.1, a small maximum aggregate size for porous surfaces is favourable for noise reduction, whereas a large maximum size improves the durability and drainage capabilities; hence the benefit of a surface such as double-layer porous asphalt. The ultimate choice however will be dependent upon the local conditions and situation where the surface is to be used.

Other material properties that should be monitored carefully are reported in Section 5.1.

Sandberg and Ejsmont [10] provide a useful summary of the general guidelines that should be followed to achieve a good quality low-noise surface, the key points of which are:

- For porous surfaces, the wearing course should be constructed with as a void content as possible from a durability perspective. An initial void content of more than 20% is a minimum to achieve good noise reduction, although 20-30% is

preferable. The thickness of a porous layer should be at least 40 mm, preferably thicker, in order to also achieve sound absorption at relatively low frequencies;

- For porous surfaces, it is essential to construct the porosity in order to prevent clogging, for example by having rather wide channels;
- Megatexture should be minimised, especially around wavelengths of 50-100 mm. This can be achieved, for example, by using uniform chippings that are not so large and having them packed close together;
- Very smooth macrotextures should be avoided. Macrotexture should be maximised at wavelengths around 2-6 mm for car tyres and 4-8 mm for truck tyres;
- The above megatexture and macrotexture requirements are easier to achieve if a small maximum chipping size is used, ideally in the range 3-6 mm, and if the chippings have sharp edges such as result when the chippings are crushed.

## 6.2.2 Production techniques

A further approach for optimising the acoustic performance of low-noise surfaces is to ensure high quality production techniques for the initial laying of the surfaces and also for longer-term maintenance procedures. A brief overview of some of the methods/techniques that are available is presented here (some of these techniques are also referred to in Section 5.1).

**Avoiding unevenness on concrete pavements:** On freshly laid concrete, the use of longitudinal “super-smoother” vibrating plates or smoothing beams is recommended to help ensure that megatexture levels are minimised. It is recommended that this is used in tandem with small aggregate sizes where possible. For concrete surfaces that have hardened, undulations can be removed in some cases by grinding the surface using densely-spaced diamond saw wheels. This removes ridges and other features which result in unevenness of cement concrete surfaces, leaving a track of fine and densely spaced grooves in the direction of the treatment.

**Avoiding unevenness on asphalt pavements:** The initial evenness obtained by the paver will remain intact, so the use of a combination-screed<sup>11</sup> with a high level of pre-compaction is preferable. The simplest way of helping to ensure smoothness is to avoid stopping and starting the paver. Paving crews should also make sure that the paving machine always has a hot mix in front of it so that there is no need to stop and wait for another load. Better compaction can be achieved through the use of automated systems.

**Warm-in-warm laying procedures for double-layer porous surfaces:** The lifetime of double-layer porous asphalt is reduced when the surfaces are laid under certain weather conditions, e.g. in low temperatures. In some countries, therefore, these surfaces cannot realistically be laid during the winter period when the low temperatures result in a rapid cooling of the upper thin porous layer. With rapid cooling the surface will tend to exhibit a poor resistance to ravelling. One possible approach for extending the potential laying period is the use of warm-in-warm technology where the two porous layers are laid

<sup>11</sup> A combination screed" is a screed which compacts the mix by means of vibrator AND tamper; i.e. it combines two means of compaction (this does not, however, eliminate the need for rolling). An alternative and probably more common term is "tamper and vibration screed".

simultaneously so that the upper layer is heated by the lower layer, thereby slowing the cooling rate of the upper layer. The equipment used for this procedure was originally designed for laying dense thin layers. Experiments using this technology have been trialled as part of the Dutch national IPG programme both in the Netherlands and in Germany. Figure 6.4 shows examples of warm-in-warm pavers in operation.



Figure 6.4: Examples of warm-in-warm pavers in operation

**Use of automation:** Avoid manual laying, as this makes it difficult to obtain the optimum evenness, durability and density of compacted asphalt surfaces. Where possible, automated laying should be used to ensure homogeneity of the pavement along its length and to ensure that the correct mixes etc are used.

### 6.3 Optimising the structural and serviceability performance of low-noise surfaces

To select a low noise surfacing a Highway Authority needs to consider the durability of important functional properties in addition to the acoustic performance of the surface. These properties include changes of texture, skid resistance, visual appearance (especially loss of material) and the binder properties.

These considerations help in the decision-making process of selecting the surface type that is best-suited to a given set of environmental and traffic conditions.

However, because there are a variety of different surfaces and each application is dependent on traffic and environmental conditions, as well as the particular acoustic requirements, it is not appropriate to provide generalised guidance on durability issues. However, studies of the durability of low-noise surfaces carried out in other projects can help to identify the factors that need to be considered and illustrate how performance has changed with time under the specific conditions encountered in the field.

More details on optimising structural durability, including details of test methods and durability measurements performed in the SILVIA project can be found in the SILVIA Project Report by Nilsson *et al* [2011] which is on the CD-ROM accompanying this manual.

A summary of UK experiences of the performance of Porous Asphalt, Thin Layers and Exposed Aggregate Concrete is given below. Other experiences in France with Porous Asphalt and Thin Layer Asphalt Concrete can be found in the SILVIA Project Report by Brosseaud and Anfosso-Lédée [102].

### **6.3.1 UK experiences with porous asphalt concrete (PAC)**

Results taken over a 12 year period from five trial sites laid with porous asphalt that carry moderate to heavy traffic have been reported by Nicholls [103] and serve to illustrate some of the main issues identified.

Two of the trials were used to investigate issues related to construction techniques, in particular the use of different binder contents and the suitability of certain binder modifiers. The latter were used mainly to reduce binder drainage during the laying process. A third trial was used to compare different European gradings and to investigate the possibility of the use of pre-coated chippings in porous asphalt. The fourth trial was used to examine the initial performance of porous asphalt overlaying jointed concrete and a fifth site was laid under standard contract conditions.

A review of skid-resistance, texture depth, hydraulic conductivity, deformation and visual condition obtained from the various sites highlighted a number of issues.

A trial on the M1 motorway indicated that porous asphalt made using a 20 mm nominal maximum size aggregate provides superior performance to finer-graded porous asphalts, in terms of relative hydraulic conductivity and surface texture. Furthermore a trial section with porous asphalt using the UK 10 mm grading yielded unacceptable performance, in terms of relative hydraulic conductivity and texture depth, and demonstrated that this material should not be used at thicknesses of 40 mm or greater.

Mixtures constructed using European gradings performed at a level in between that of the mixtures with the UK 20 mm and 10 mm gradings. A trial in which pre-coated chippings were inserted into porous asphalt also showed that this can be laid successfully and that the chippings will be retained.

It was reputed that porous asphalt had a lack of skid resistance in its very early life due to the thick binder film covering the aggregate at the surface. However, evidence from the M1 and a further site on the M40 motorway, indicated that the skidding performance expected from traditional surfacings, as measured by the Sideway-force Coefficient Routine Investigation Machine (SCRIM), was attained after less than three weeks of trafficking. Furthermore, skid-resistance on the M40 was comparable to that of an existing brushed concrete surfacing within 3 days of trafficking. This was not unlike traditional surfacings, such as hot rolled asphalt which also require trafficking to fully expose the aggregate.

The M40 trial also examined whether porous asphalt could be successfully laid over jointed concrete. The trial established that the joints have to be sufficiently 'hard' (as opposed to 'rubbery', which is an important property for the normal operation of a joint sealant) to minimise the possibility of material being forced into the joints during compaction only to be expelled afterwards. The emergence of reflective cracks only occurred in relatively limited locations in the first two years of trafficking and did not spread extensively after five years in service. The extent of reflective cracking over the full lifetime of the porous asphalt has still to be fully evaluated.

Overall, these trials have shown that it is feasible to lay porous asphalt under normal contractual conditions on moderately heavily trafficked motorways. Porous asphalt can remain structurally viable for up to twelve years under traffic loads of up to 4,000 cv/l/d, although the condition at the end of that time may no longer offer significant advantages when compared with non-porous surfaces.

From appraisal of the results of road trials and literature it became apparent that when considering the durability of Porous Asphalt (PA), both the durability of the mixture and the durability of the binder should be considered [104]. This is discussed below.

#### **6.3.1.1 Binder durability**

It has been found that the length of serviceable life of porous asphalt is generally governed by progressive binder hardening until the binder can no longer accommodate the strains induced by traffic [105]. It follows therefore that the service life of the surfacing is largely controlled by the influence of the climate on the oxidation of the binder, with traffic being an important but secondary consideration.

Brittle fracture generally begins during winter and, if the surfacing survives the winter, it usually remains serviceable during the following warmer months. An indication of imminent failure is often provided by the onset of fretting in the wheel-paths accompanied by an increase in texture depth. The penetration of the binder recovered from porous asphalt has been shown to harden with time. Between mixing and laying, the typical reduction in penetration is 30% and then proceeds at about 20% reduction in penetration per year.

Irrespective of the presence or type of modifier, the critical binder penetration is around 15 dmm with the softening point generally close to 70 °C, after which failure generally occurred when subzero temperatures are next encountered.

It has been found that porous asphalts with higher binder contents, or that have hydrated lime incorporated, have lower hardening rates, and hence increased durability. The increase in service life with increased binder content is attributed to a thicker binder film that takes longer to oxidise. Therefore, the binder content for a particular maximum nominal aggregate size may be considered as a surrogate for binder film thickness, and hence durability.

#### **6.3.1.2 Mixture durability**

Closely allied to binder durability is mixture durability, which can be defined as the ability of the surfacing to remain serviceable under the influence of traffic stresses. Generally in the United Kingdom, the mixture durability has not been a problem until the binder has hardened to its critical penetration. However, the material, with its interconnecting voids, appears inherently weak, and so some reassurance about the durability of the mixture may be required and can be estimated using the particle loss test [106]. This test is also known as the Cantabrian test, and has been developed specifically for porous asphalt. The test involves rotating specimens in a Los Angeles machine, without steel balls, and measuring the weight loss after a set number of rotations. Although the stresses imposed during the test do not closely simulate traffic stresses, the test does indicate how well a material remains intact under stress. From limited trials a particle loss of not more than 10 per cent appears to provide an assurance of mixture durability. However, as with other pavement materials durability of a mixture depends on good workmanship as well as selection of an appropriate mixture. Therefore, the test is used to check on compaction by

taking cores from the completed mat and measuring the particle loss, which should not be significantly greater than that achieved at the laboratory design stage. It is understood that there will be some differences due to the different forms of compaction used in the laboratory and on site, but a large increase in particle loss will indicate that inadequate compaction has taken place and that the material may not achieve the expected design life.

### 6.3.2 UK experiences with thin wearing courses

Further information on the durability of thin surfacings can be found in a paper by Nicholls and Carswell [107].

For convenience, thin surfacings can be subdivided into categories based on the product from which they were developed [44] as follows:

Table 6.4: Categories of thin surfacings

Name	Abbreviation	Description
Paver-laid surface dressing	(PLSD)	Ultra-thin surfacings developed in France
Thin asphalt concrete	(TAC)	Generally with polymer-modified binder
Thin stone mastic asphalt	(TSMA)	Generally unmodified bitumen with fibres
Multiple surface dressing	(MSD)	Binder and aggregate applied separately
Micro-surfacing	(MS)	Thick slurry surfacing, generally with modified binder

When introduced into the UK thin surfacing systems initially needed to gain Highways Agency approval before they could be routinely used on trunk roads in England. The Highways Agency approval system was superseded by the *Highways Authorities Product Approval Scheme* (HAPAS) run by the British Board of Agrément (BBA) [108].

Some of the thin asphalt surfacings laid in the UK in the 1990s are now reaching their expected serviceability lives and therefore it has become possible to confirm their assumed service lives. It is also now possible to gain an understanding of how they subsequently deteriorate when they reach the end of their 'acceptable' service life. A selection of these early sites have therefore been monitored to assess the durability of various systems. The sites tended to be those that were used to gain Highways Agency approval for products prior to the availability of BBA-HAPAS certificates.

The findings from the monitoring showed that thin surfacing systems can be routinely constructed to provide a safe surfacing with adequate skid-resistance, texture and visual condition and that these properties are maintained in service. The evidence was used as part of the acceptance procedure used by the Highways Agency to approve their use on trunk roads in England.

The principal findings of the work to date are that:

- The definition of performance if the thin wearing courses is not consistent across all highway authorities, and the time at which surfacings are replaced can vary considerably;
- If a thin surfacing system is in good condition after its first year in service, it will be serviceable for at least 5 years and probably in excess of 8 years;
- Thin surfacings are not likely to fail prematurely due to loss of skid resistance. The reduction in skid resistance, through polishing in the normal manner, appears to take over 10 years to develop;
- Thin surfacings are not likely to fail prematurely due to loss of texture depth, but an increase in texture depth after at least 7 years in service may indicate some loss of aggregate that should influence the visual assessment rating.

Overall findings of the monitoring to date suggest that different categories of thin surfacing systems deteriorate at different rates. Based on the data obtained, typical values of service life may be ascribed to the different categories, according to the chosen end condition, as indicated in Table 6.5 below.

Table 6.5: Typical lifetimes for thin surfacing systems (based on UK experiences)

Surfacing Category	Time to reach condition (years)				
	Moderate	Acceptable	Suspect	Poor	Bad
PLSD	4.7	8.2	11.5	>12 (14.8*)	>12 (18.0*)
TAC	7.5	>12 (15.1*)	–	–	–
T SMA	11.5	–	–	–	–
MSD	3.9	6.1	7.6	8.8	9.8

\* Extrapolated value that is probably optimistic

### 6.3.3 UK experiences with exposed aggregate cement concrete (EACC)

Further details on the durability of exposed aggregate concrete can be found in a report by Chandler *et al* [200].

Durability has been an important consideration of development of exposed aggregate concrete (EACC), which was carried out with the aim of producing quieter concrete surfacings, and to measure durability, visual inspection, skidding resistance and texture were used. Surfaces constructed with this material in the UK were laid on five trial sites of which the M18 and A50 were regularly monitored for texture, skid resistance and noise over five years.

#### 6.3.3.1 Construction

Durability is largely reliant on the quality of workmanship which means that construction of EACC should be as straightforward as possible. In this regard various points were of note:

- Pavements with exposed aggregate concrete surfacing may be constructed in one or two layers, by slipforming or between fixed forms. The coarse aggregate must be of small maximum size, have a high Polished Stone Value (PSV) and a low Flakiness Index. The fine aggregate must comply with a finer grading than normal pavement quality aggregate;
- Reliable guidance as to when to brush the concrete surface to expose the coarse aggregate is required. A result of the lack of guidance is variable texture depths along the pavement, and hence serviceability issues. An illustration of the variability along a single site is seen in Figure 6.5 which shows results from a section of EACC laid on the A13;

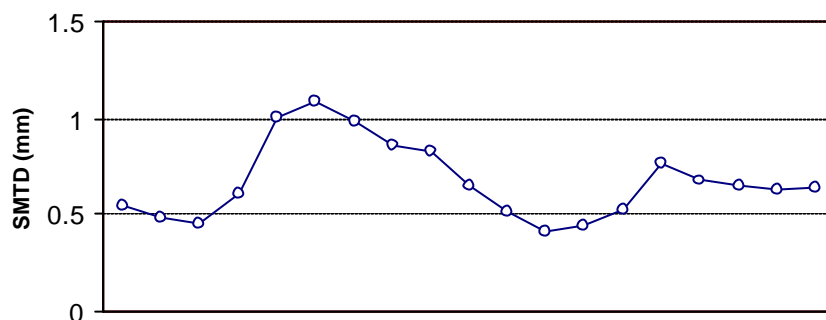

Figure 6.5: Variation of SMTD along the A13 (Westbound). Each point corresponds to the SMTD for an individual 100 m EACC section along the test site

- A method of determining the optimum time to brush the concrete, based on the maturity of the concrete, indicated that a maturity of 16 hours is required to achieve sufficient strength to avoid aggregate plucking out of the surface and damage from the brushing equipment;
- Brushing the surface at 16 hours maturity allows sufficient time for the texture depth to be checked and additional brushing to be effective in increasing the texture depth if required.

### 6.3.3.2 Texture measurements

The EAC pavements monitored for texture were on the M18, A50 and the A13 they included both the 10-6 mm and 14-8 mm aggregate sizes used at that time in the UK.

From the small range of stone counts noted it was found that the aggregate size and the amount of coarse aggregate at the surface was less important in determining the level of texture achieved than the degree to which the aggregate is exposed.

The texture level of an EACC road can be expected to remain largely unchanged for many years in traffic. Any loss of texture will be governed predominantly by the rate of wear of the exposed aggregate particles.

It is clear from the ranges of texture obtained on the various sites studied that care is needed during the aggregate exposure process to ensure that a consistent and adequate texture depth is obtained.



### 6.3.3.3 Skid resistance

It was expected that the low-speed skidding resistance on the EACS would depend primarily on microtexture provided by the exposed aggregate. The skidding resistance measured with SCRIM on all the EACC roads was consistent with what would be expected for any homogenous surfacing using similar aggregates under similar traffic conditions.

As indicated above, the EACC surfacings showed a wide range of texture depths. However, the high-speed skidding resistance performance of the EACS was found to be consistent with that observed for other typical surfacing types, with the greatest loss of friction at higher speeds occurring on the surfaces with the lowest texture depth.

### 6.3.3.4 Overall comments

To date there has been very little change in texture depth on the sites.

As would be expected on roads such as these, with intermediate levels of heavy traffic, the skidding resistance fell slightly during the first year or so after opening. The last of these skidding resistance measurements, taken after about 5 years trafficking, was probably at, or around, the equilibrium level for the site.

Visually, the pavements have performed well with the exception of some cracking and material loss at a number of arrises on transition slabs adjacent to the continuous reinforced concrete pavement (CRCP). This was attributed to workmanship and not an inherent problem with the design or the construction techniques.

It would appear from the monitoring of texture, skidding resistance and noise on the M18 and A50 EACC sites, that the specification used for the aggregates produced a satisfactory and durable surfacing. It also seems that to enable effective monitoring of large areas of pavement sensor measured texture depth should be used.

## 6.4 Development work on low-noise surfaces carried out within SILVIA

### 6.4.1 Thin layers – site tests in Denmark

As part of the SILVIA project, a study known as SILVIA-DK was undertaken to develop and test thin layers as noise reducing pavements. Of particular interest was to examine the construction and performance of these surfaces for conditions typically encountered in Nordic countries. Test sections were constructed in three Danish cities (Copenhagen, Aarhus and Randers). All of the test sections were located on urban roads with an average vehicle speed of 50-60 km/h and an AADT of 6700-12500 and approximately 8% heavies.

The design of the test pavements was based on the current knowledge and technology available in Denmark and a study of the most recent experiences in the Netherlands and other European countries. The goal was to develop thin layer pavements with the following functional requirements:

- To have as smooth a top surface as possible in order to minimize the noise generated by vibrations in the tires. Pavements with a maximum aggregate size of 6 mm were selected for the study to achieve this;
- To have as open a surface as possible in order to minimize the noise generated by the air pumping effect. In this case, the term “open” refers to the surface of the pavement only as the pavements were not designed to be porous. Porous pavements are characterised by an open structure that has connected air voids throughout the entire thickness of the layer. In one of the test pavements a certain amount of larger aggregate (size 58 mm) was used in order to increase the openness of the top surface.

Three test pavements were constructed as follows:

- Open graded asphalt concrete (AC-open) with a (built-in) Marshall air void<sup>12</sup> of approximately 8-14%;
- Stone Mastic Asphalt (SMA) with a (built-in) Marshall air void of approximately 4-8%;
- A thin layer constructed as a combination pavement (TPc). The method of construction involves initially spreading a thick layer of polymer modified bitumen emulsion (including water) over the underlying layer or road subbase. On the top of this a very open pavement (like porous asphalt) with a (built-in) Marshall air void of approximately 14% or even more is laid. The hot porous asphalt causes the bitumen emulsion layer to soften and to “boil up” into the air voids of the pavement, leaving only the upper part of the structure open. This essentially reduces the overall porosity of the surface layer whilst retaining an open structure to the top surface of the pavement. The maximum aggregate size was 8 mm.

Reference pavements for the study were constructed using a dense asphalt concrete mix with 8 and 11 mm maximum size aggregates.

Figure 6.6 shows the maximum noise level for passenger cars at 60 km/h based upon the results of SPB measurements taken at the site at Copenhagen when the surfaces were approximately 6 months old. The results obtained from the other test sites were of a similar magnitude.

These initial results indicated that when the pavements were around 6 month old, the combination pavement (TP6c) offers the best noise reducing potential when compared with the reference surfaces. The noise reductions achieved were of the order of 3 dB. The open asphalt concrete (AC6o) and the SMA pavements gave a corresponding noise reduction of 2 dB. The results also show the importance of the choice of reference pavement for an experiment with noise reducing pavements.

---

<sup>12</sup> A Marshall air void is the air void measured on samples produced using the Marshall mix design method in the laboratory

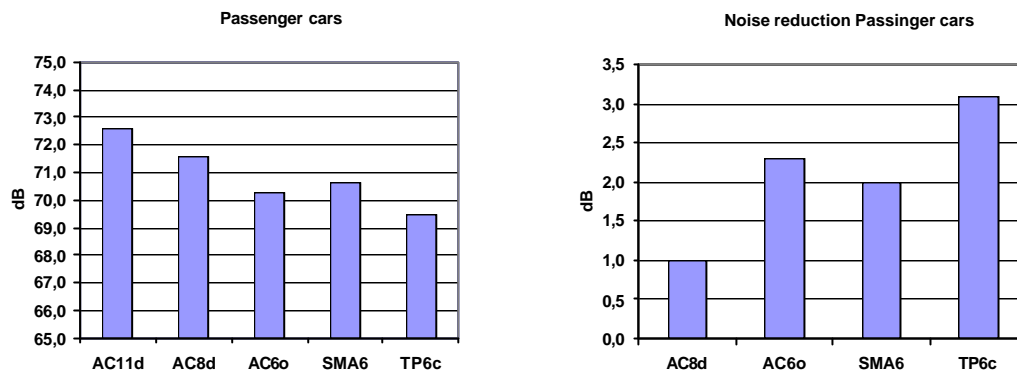

Figure 6.6: SPB levels at 60 km/h for passenger cars on SILVIA-DK urban test sections in Copenhagen and noise reductions relative to the DAC 11 reference surface. Surface types: AC11d: Dense asphalt concrete 0/11; AC8d: Dense asphalt concrete 0/8; AC6o: Open-graded asphalt concrete; SMA6+ Stone mastic asphalt; TP6c: Thin layer combination pavement

As part of a co-operation between the Dutch (DWW) and Danish (DRI) national road institutes within the Dutch national IPG programme, a project has been carried out to investigate both the acoustical and structural lifetime of noise-reducing thin layers. This project is making use of the SILVIA-DK surfaces as well as laying new surfaces on highways in Denmark and the Netherlands. In the summer of 2004 four test sections with thin layer pavements as well as a dense asphalt concrete reference surface with maximum 11 mm aggregate size were constructed on the M10 highway near Solrød, Denmark. At this site, the traffic volume is around 80,000 vehicles per day and the speed limit is 110 km/h. The test sections were as follows:

- SMA8: Stone Mastics Asphalt (SMA) with a (built-in) Marshall air void of approximately 12%. The pavement is constructed like a porous pavement with a stone skeleton. The voids are filled with bitumen and filler, leaving only the surface structure open;
- AC8o: A dense, but very open graded asphalt concrete (AC-open) with a (built-in) Marshall air void of approximately 15%;
- TP8c: A thin layer constructed as a combination pavement (TPc). This surface was constructed using the same techniques as described earlier in the study carried out in Denmark;
- SMA6+: Stone Mastics Asphalt (SMA) with maximum 6 mm aggregate size, but with a small amount of 5/8 mm aggregate added.

Table 6.6 shows the maximum noise level for passenger cars at 60 km/h based upon the results of SPB measurements taken at the site at Copenhagen when the surfaces were approximately 4-5 months old [109].

Table 6.6: SPB levels and noise reductions relative to a DAC 11 reference surface for SILVIA-DK highway test sections on the M10 near Solrød.

(Reference speed is 110 km/h for passenger cars and 85 km/h for trucks. For the standardized SPB index the traffic composition is 70 % passenger cars, 7.5 % dual-axle trucks and 22.5 % multi-axle trucks.) [109]

Road	Passenger cars		Dual-axle trucks		Multi-axle trucks		SPB INDEX	Noise reduction
	SPB level	Noise reduction	SPB level	Noise reduction	SPB level	Noise reduction		
AC11d	82.4	---	88.0	---	89.3	---	86.3	---
SMA8	81.9	0.5	86.3	1.7	88.1	1.2	85.3	1.0
AC8o	79.4	3.0	85.4	2.6	87.0	2.3	83.8	2.5
TP8o	80.2	2.3	85.2	2.8	87.5	1.8	84.3	2.0
SMA6+	80.8	1.6	87.0	1.0	88.1	1.2	85.1	1.2

It can be seen that the very open graded asphalt concrete (AC8o) has the best noise reduction, when compared with the dense asphalt surface, of 2.5 dB. The noise reduction for trucks is only slightly smaller than for passenger cars, indicating that thin layers also has a good noise reducing effect on truck noise at highways with high speeds.

#### 6.4.2 Poro-elastic surfaces: Laboratory tests and site tests in Stockholm

The objective of the study was to develop and test a poro-elastic road surface (PERS) which would provide a durable road traffic noise reduction. Full details of the study are reported by Sandberg and Kalman [110, 111]. Based on laboratory tests investigating adhesion between the PERS and the base course, permeability, friction and wear performance, particle emissions, compression under load, sensitivity to clogging, sound absorption, rolling resistance and noise tests on a laboratory drum, three types of poro-elastic surface were selected for further study. These surfaces were laid on one lane of a street in Stockholm City carrying a mix of light and heavy traffic (5400 AADT, 8% heavies and 50 km/h speed limit), as shown in Figure 6.7 and are as follows:

- *Tokai* surface: Constructed from prefabricated rubber panels with dimensions 1×1 m<sup>2</sup> that were imported from Tokai Rubber Industries Ltd. in Japan. The surface was only laid over a small area, i.e. two wheel tracks 2×36 m<sup>2</sup>). This was similar to a surface previously tested in Japan [112] but with improved friction;
- *Rosehill* surface: Constructed from prefabricated rubber panels with dimensions 1×1 m<sup>2</sup> that were produced by Rosehill Polymers Ltd. in the U.K., based on specifications by the Swedish National Road and Transport Research Institute (VTI). It should be noted that the panels had chamfered edges;
- *Spentab* surface: This was a site-constructed rubber-based mix, designed by Bjorn Kalman from VTI and produced by Spentab AB, a Swedish company producing somewhat similar surfaces for playing grounds and sports arenas.



Figure 6.7: Poro-elastic road surfaces trialled in Stockholm, Sweden [111]

Figure 6.8 shows CPX and CPB results at 50 km/h. The figure shows that the Rosehill surface is somewhat less efficient in reducing noise than the other two. One reason for this may be the chamfer on the rubber panel edges which created a v-shaped "channel" some 10 mm wide spaced at 1 m intervals. The Tokai panels had no chamfer and as a result, the joints between the panels were relatively smooth (i.e. approximately 2 mm width gaps between panels). The passage of tyres over the joints between the Rosehill panels was clearly audible and is therefore a possible explanation for the slightly higher noise levels found for this surface.

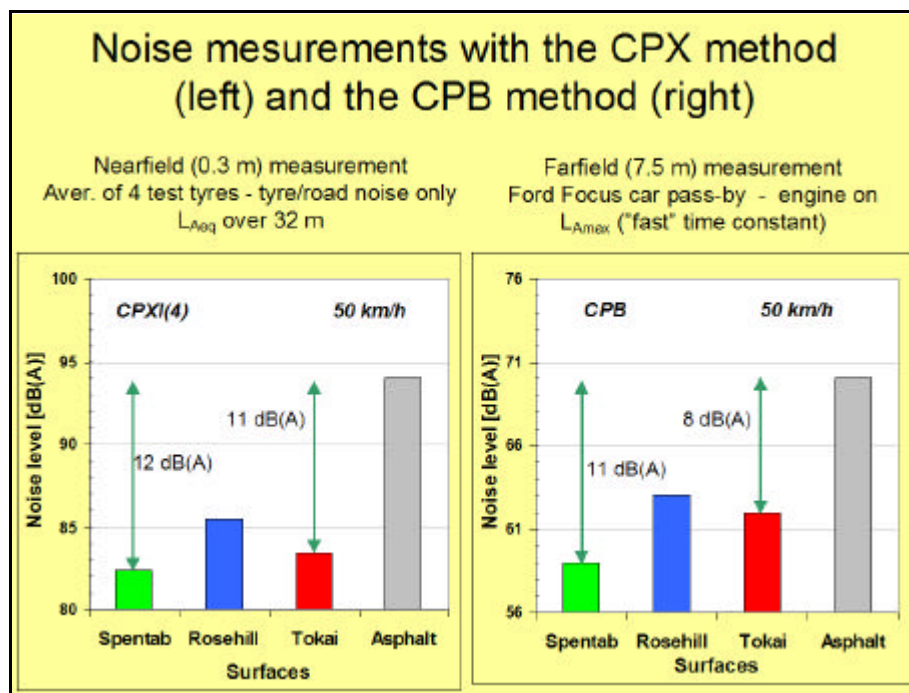

Figure 6.8 Results of CPX (left) and CPB measurements (right) on the test sections, at a test speed of 50 km/h [111]

The following conclusions can be drawn from the experiments:

- There was a loss of adhesion between the PERS and the base course. This was attributed to the fact that the PERS was initially laid on an asphalt surface in poor condition. Some of the aggregates in the underlying asphalt surface were loose and these tended to penetrate the rubber-asphalt interface which weakened the bond between the layers. It was felt that on regular asphalt in good condition, sufficient adhesion was possible with all the materials examined. For the rubber panels, adhesion rubber-to-asphalt generally was better than asphalt-to-asphalt. It is essential therefore to have a very strong asphalt base course, without any weak adhesion between asphalt layers (even with a 30-50 mm thick asphalt).
- Although all of the materials had acceptable initial friction, the Rosehill panels require further improvement. The Rosehill panels were ordered with friction-increasing fibrous material, but after delivery it was found that they did not have such extra material;
- As on all porous wearing course materials, frost or black ice may form earlier than on dense materials; such conditions must be counteracted by preventive de-icing (by salt). Snow and ice is substantially better removed from the PERS surfaces by traffic than is the case on regular asphalt;
- Traffic noise reduction on a 50 km/h street was found to be potentially very large, i.e. 8-11 dB(A) initially (for light vehicles); slightly better performance was found at 70 km/h. It was noted that the presence of the chamfered edge had a detrimental effect on the noise levels – for optimal performance, there must be no change in the profile of the surface at the panel joints;
- Rolling resistance seems to be no problem; being approximately the same as on smooth asphalt;
- No significant wear on the rubber surfaces exposed to traffic could be noticed. Regular wear by studded tyres, which was tested in the laboratory, seems to be almost negligible. Particle emissions are very low; potentially even giving a healthier environment than asphalt. Additionally, neither hard braking or wheel spin jeopardizes the durability of surfaces;
- All of the tested materials retained water within the surface layer rather like a sponge. This will tend to reduce the porosity of the material during wet weather and could therefore reduce the noise reduction benefits while the surface is drying out. The presence of water in the layer also indicates that a good drainage system in the underlying layers is needed in much the same way as required for porous asphalt. However, it is anticipated that the water retention characteristics of the surface could also have beneficial effects in that clogging of the surface is less likely;
- In areas where heavy snow falls are likely, the problem of winter maintenance was identified. For example, the use of snow ploughs on this type of surface could cause damage particularly if the surface is uneven. However, the snow ploughs can probably be adjusted to give a few mm clearance to the surface since snow and ice are less likely to adhere to a PERS surface.

- Regarding costs, the Spentab surface is very inexpensive in all aspects (the costs would probably be lower than or match those of a simple noise barrier), the Tokai surface is very expensive, and the cost of the Rosehill surface is somewhere in between.

The following general issues were identified as requiring consideration in future studies:

- The curing time (for surfaces manufactured on site), as well as laying time, must be shortened. Where pre-manufactured panels are used, material and laying costs need to be reduced;
- For in-situ mixes, the use of larger laying machines and provision of an even finished surface is an important issue;
- It is essential to make sure in advance of any tests with PERS that the adhesion between the two upper base course layers is sufficient;
- It should be studied whether the rubber layer creates a more severe dynamic loading of the base course than no rubber layer at all.

More specific issues, related to the individual samples are discussed in the report by Sandberg and Kalman [110].

### **6.4.3 Low noise surfaces effective also for severe winter conditions**

Since most promising low-noise surfaces have been tested in middle-European climates, there is a lack of experience as to their performance under severe winter conditions (with ice, freezing rain, frequent winter maintenance, the use of studded tyres etc.). To overcome this limitation, the most promising surface types were constructed and evaluated under Swedish winter conditions. This would also represent typical Norwegian and Finnish conditions. The single- and double-layer porous asphalt surfaces and a thin-layer surface were identified as the most promising and favourable surface types for winter climate. The test sections and the reference surface were located on motorway E18 outside of Stockholm, with a speed limit of 110 km/h and an AADT of about 20,000, of which approximately 12% is heavy traffic.

In general, the harsh climate conditions call for highly durable surfaces to provide acceptable performance and surface life. Traditional asphalt mixes used in Sweden use high quality, large size (16 mm) crushed aggregate to withstand wear from studded tyres. Smaller aggregate gives lower noise emission but poor resistance to wear so the optimisation to address both durability and noise reduction was highly important. The main objective was to optimize the noise reduction using relatively large maximum aggregate particles without sacrificing durability. The large temperature ranges experienced during freeze and thaw cycles required the use of polymer-modified binders.

The design of the mixes was based on local experiences and best practice, as well as the most recent knowledge and technology available in Europe. The thin-layer surface was optimised to provide favourable texture with respect to noise reduction, whereas the single- and double-layer porous asphalt were optimised to comprise a high void content.

The tested mixtures were as follows:

- Thin layer (TSF) with a maximum aggregate particle size of 11 mm with an air void of approximately 5%;
- Single-layer porous asphalt (PAC) with a maximum particle size of 16 mm with a design air void of approximately 20%;
- Double-layer porous asphalt (DPAC) with a maximum particle size of 11 mm in the top layer and a design air void content of 25%, whereas the bottom layer has a maximum particle size of 16 mm and an air void of approximately 20%.

The reference surface was stone mastic asphalt (SMA) with a maximum particle size of 16 mm and an air void of approximately 3%. The selected reference surface is the most commonly used on highways in Sweden.

An extensive test programme was carried out including SPB measurements at different microphone heights, CPX measurements using standard tyres as well as a studded tyre, permeability measurements, friction tests, evenness measurements, texture measurements and laboratory tests on cores. The major results are presented below (a comprehensive report of the results from the test sections is included in the CD-ROM Appendix).

#### 6.4.3.1 Results of noise measurements

##### **CPX measurements**

Figure 6.9 shows the CPXI noise levels measured each year at a speed of 80 km/h; Figure 6.10 shows the corresponding reduction relative to the reference surface.

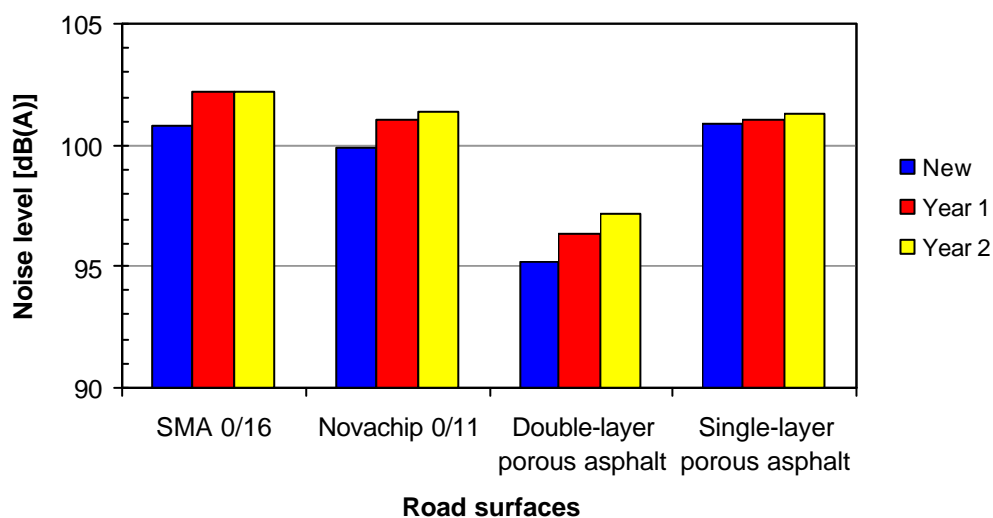

Figure 6.9: CPX measurements on low-noise test sections and a reference surface on the E18, Sweden



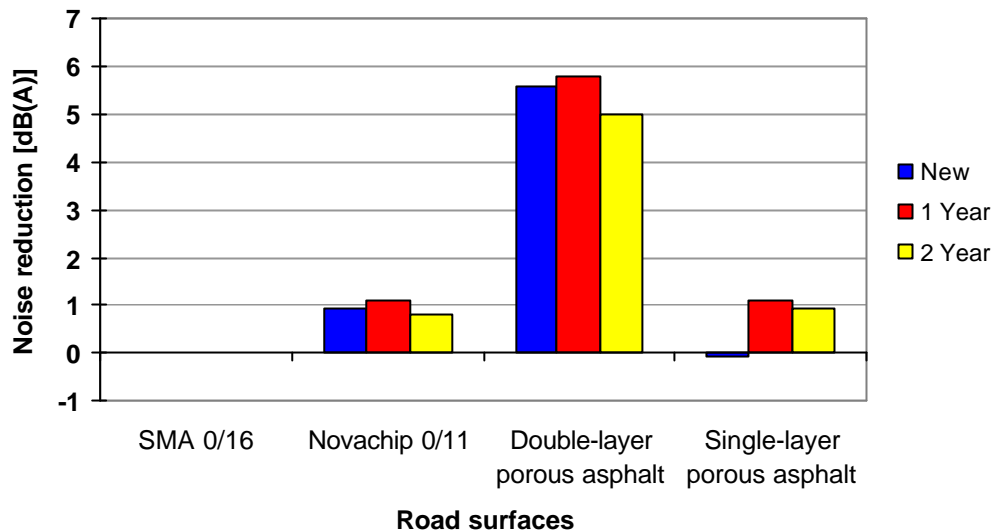

Figure 6.10: CPXI noise reductions from low-noise test sections on the E18 relative to the SMA16 reference surface

It can be seen that the double-layer porous asphalt has an initial reduction of 5.6 dB(A) which reduces to 5 dB(A) after two years. The single-layer porous asphalt and the thin layer do not indicate any substantial noise reduction, being of the order of 1 dB(A). These results are unexpected for the single-layer porous asphalt. No direct explanation has been found to account for this phenomenon. Potential causes may be that unfavourable longitudinal unevenness is causing significant tyre vibration, that only a limited number of interconnected pores have been formed in the single-layer porous asphalt or that the pores have already become clogged prior to the first measurements. However there is currently no evidence to confirm any of these possibilities.

#### **SPB measurements**

Figure 6.11 shows the microphone arrangement used for performing the SPB measurements. Two microphone heights were used, namely 1.2 and 3.5 m. SPB measurements were performed in 2003 and 2005.



Figure 6.11: The low (1.2 m) and high (3.5 m) microphone positions used for the SPB measurements on the E18, Sweden. This is the section with double-layer porous asphalt measured when it was two years old. Note that the photo is highly zoomed; in reality the road at the site is totally horizontal and straight.

Figure 6.12 shows the maximum noise levels for passenger cars at a speed of 100 km/h and heavy vehicles at a speed of 85 km/h measured at a microphone height of 1.12 m.

In this Figure there is a horizontal line labelled “HARMONOISE”. This is a more relevant reference case for general European conditions than the SMA surface. In the HARMONOISE project, a virtual reference surface was determined which was decided to be a mix of an SMA 0/11 and a DAC 0/11 (see Section D.3.2). Either an SMA 0/11 or a DAC/11 were considered to be reference cases which would be found as relatively common surfaces in all European countries whereas, for example, an SMA 0/16 would be used extensively only in the Nordic countries. This reference is the case on which all future European noise predictions, as developed in the HARMONOISE and IMAGINE projects, shall be based. Consequently, the HARMONOISE virtual reference surface would also be a suitable reference here. To determine the value of this reference level, there is a correction procedure in HARMONOISE that was followed (this only applies to light vehicles; for heavy vehicles the corrections are zero).

It should be noted that the temperatures during measurements in 2005 were substantially higher than in 2003 (approximately 10°C higher). No correction has been made for this. This will affect the comparison between the measurements in the different years; the levels for light vehicles in 2005 should be increased by approximately 0.5 dB in relation to 2003, but it does not significantly affect the comparison between the surfaces.

Figure 6.13 shows the corresponding noise reductions for the two vehicle categories relative to the HARMONOISE reference surface. In the case of the thin layer and light vehicles, an initial noise reduction of approximately 2 dB(A) was observed; this reduced to 1.5 dB(A) after two years. For heavy vehicles, the reduction was 1.5 dB(A) on both the measured occasions. For the single-layer porous asphalt, the initial noise reduction of 4 dB(A) increased to 6 dB(A) after two years for light vehicles. For heavy vehicles the corresponding values were 4 and 5.5 dB(A) respectively. The increase in noise reduction

with surface age is unique and was totally unexpected. However, the reason for this can be identified when checking the frequency spectra. When the surface was new, the maximum noise reduction occurred at a frequency which was not ideal with respect to where the maximum acoustic energy of the traffic is located in the frequency spectrum; there was simply a mismatch between the two. However due to some process occurring in the surface, perhaps aided by clogging, the frequency of maximum noise reduction shifted from the first measurement to the second one in a favourable direction, resulting in a better match with the traffic noise spectrum in 2005 than in 2003.

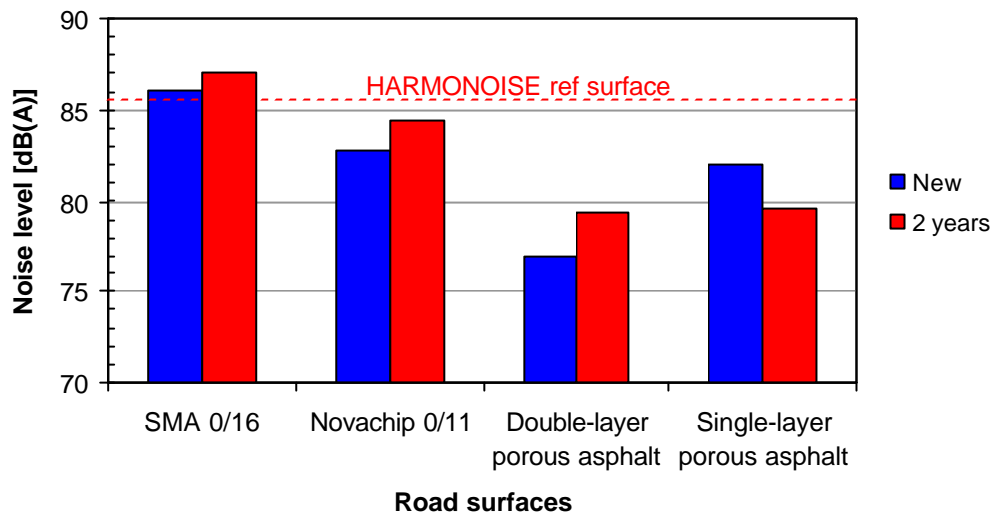

(a) Light vehicles, speed = 110 km/h

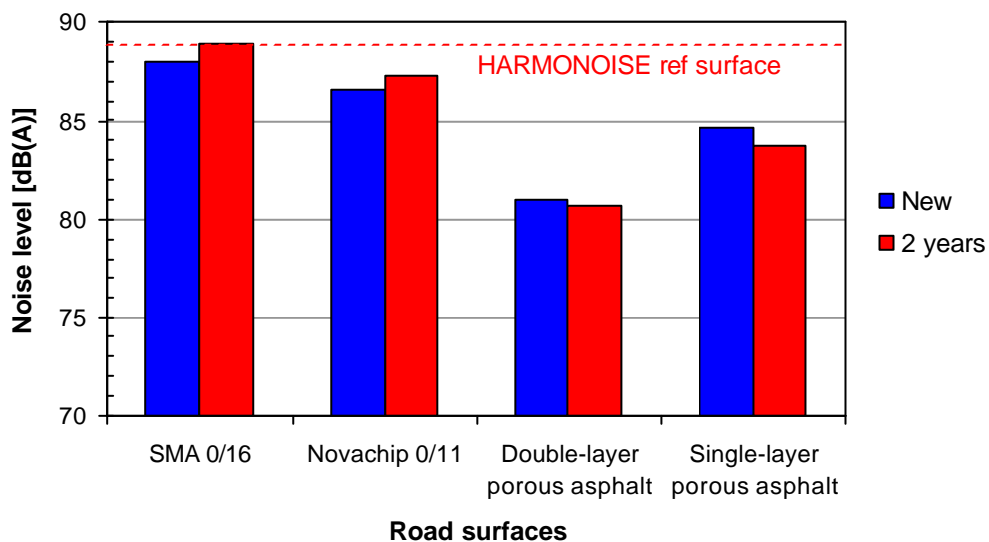

(b) Heavy vehicles, speed = 85 km/h

Figure 6.12: SPB noise levels (microphone height = 1.2 m) in 2003 ("New") and 2005 ("2 years") on low-noise test sections on the E18

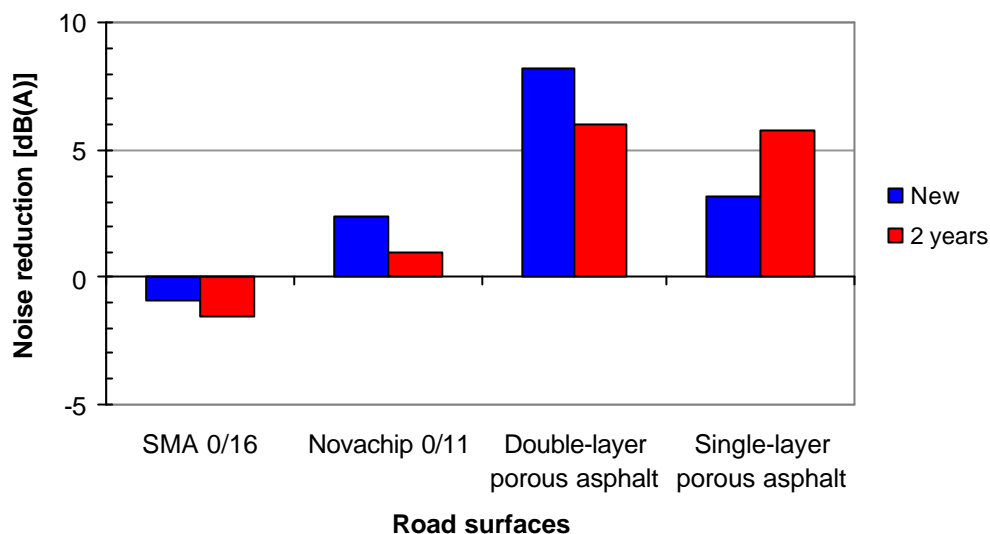

(a) Light vehicles, speed = 110 km/h

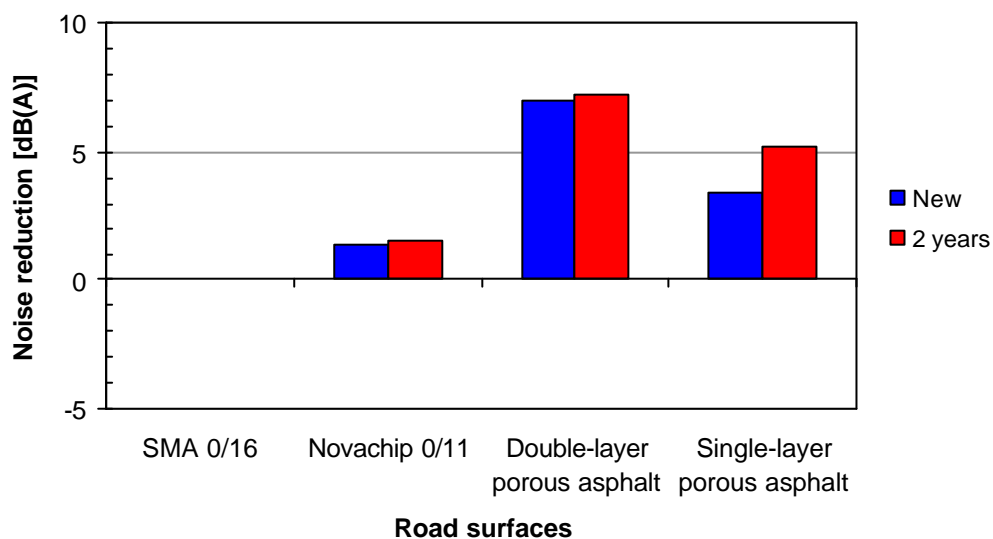

(b) Heavy vehicles, speed = 85 km/h

Figure 6.13: Noise reductions measured with the SPB method (microphone height = 1.2 m) in 2003 ("New") and 2005 ("2 years") of low-noise test sections on the E18 relative to a HARMONOISE virtual reference surface

The most relevant results are those measured with the SPB method. The differences in the CPX and SPB measurements are yet to be explained. The noise reduction of the double-layer porous asphalt and the single-layer porous asphalt is almost equal after two years according to the SPB measurements but very different according to the CPX measurements.

The selected reference surface, SMA 0/16, is the most widely used surface type on Swedish highways. The results indicate that there is a potential for substantial noise

reduction using rather large maximum aggregate particle sizes, not only in Sweden but also in the rest of Europe. This seems to be particularly so when looking at performance after considerable exposure of the surface to traffic. It appears from this experiment that the concentration on the development and use of porous asphalt with small aggregate sizes (in the top layer) is not fully justified. One may achieve equally good, if not better, results with large aggregates provided that the design of the surface is good. However, it is not known whether equally good results would be achieved at speeds of 50 km/h.

The structural durability of all the tested surfaces is satisfactory. No surface damage has yet been detected during the two first years of operation.

#### 6.4.3.2 Additional measurements

As part of the same programme the following additional measurements have been made:

##### Initial texture measurements

Initial texture measurements were carried out using the VTI mobile laser profilometer (speed = 36 km/h) and the results are presented in Table 6.7.

*Table 6.7: Results of texture measurements on low-noise test sections and a reference surface on the E18, Sweden*

Surface	MPD	ETD	RMS	L <sub>ma</sub>	L <sub>me</sub>	L <sub>Tx80</sub>	L <sub>Tx5</sub>
SMA 16	1.13	1.10	0.811	57.3	53.3	50.4	43.2
Thin layer (TSF)	1.47	1.37	0.948	58.9	53.3	50.6	45.9
Double-layer porous asphalt (DPAC)	2.05	1.84	1.390	62.2	56.6	53.7	50.7
Single-layer porous asphalt (PAC)	2.31	2.05	1.870	64.8	59.9	57.1	51.7

##### Friction measurements

Wet friction measurements were made with a BV11 machine during 2003 and 2004 using a fixed slip method (slip = 15%) at a speed of 70 km/h. Two runs were made on each surface and the measurements taken in the wheel track closest to the road shoulder. The results of the measurements are given in Figure 6.14. It can be seen that there was no problem with the wet friction coefficient even though a large amount of polymer modified bitumen was used to coat the aggregates. It is noted that the limiting value is 0.5 with this method in Sweden.

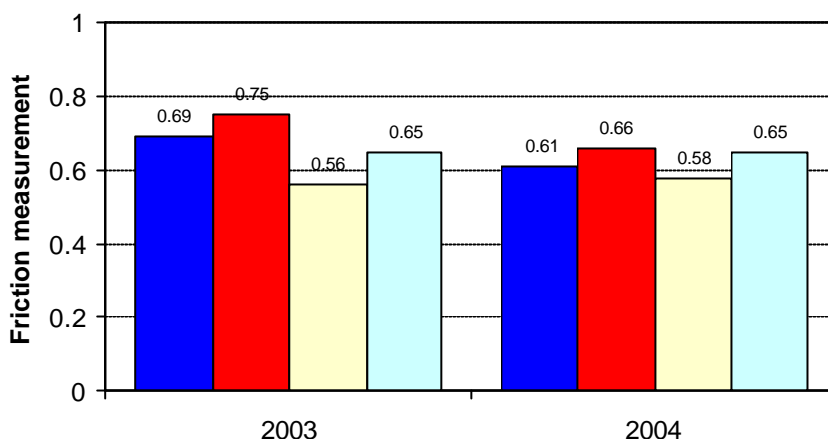

Figure 6.14: Results from friction measurements on low-noise test sections and a reference surface on the E18, Sweden; ■ SMA16; ■ TSF; ■ PAC; ■ DPAC

### Sound absorption tests.

In order to evaluate the contradictory noise levels measured by the CPX and SPB methods it was decided to send cores of the single- and double-layer porous asphalt to M+P in the Netherlands for a sound absorption test. The results in terms of the sound absorption coefficient as a function of frequency are given in Figure 6.15 and Figure 6.16.

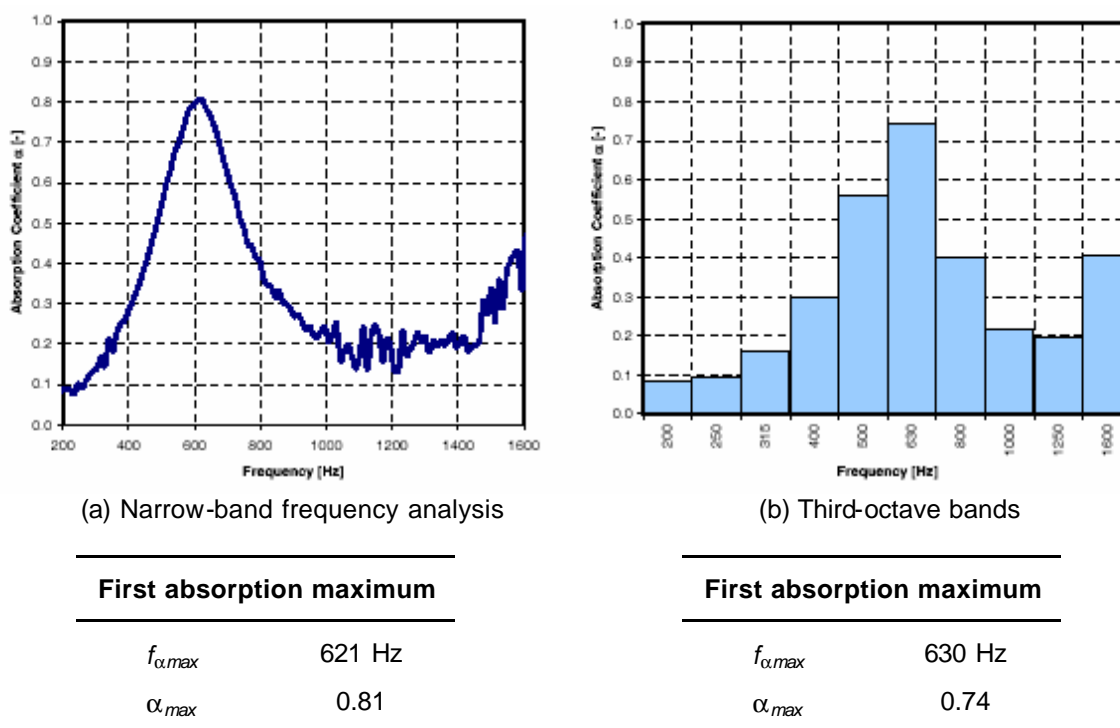
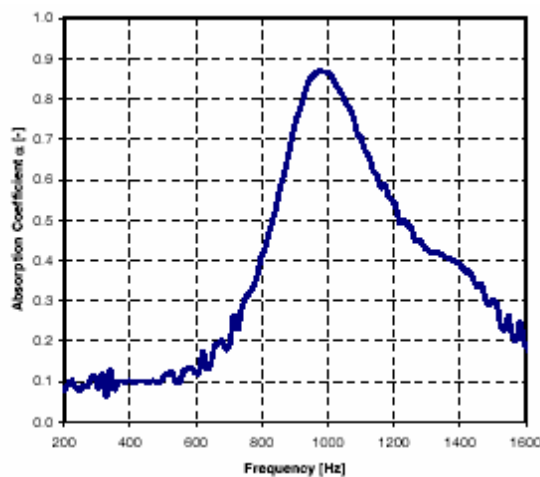
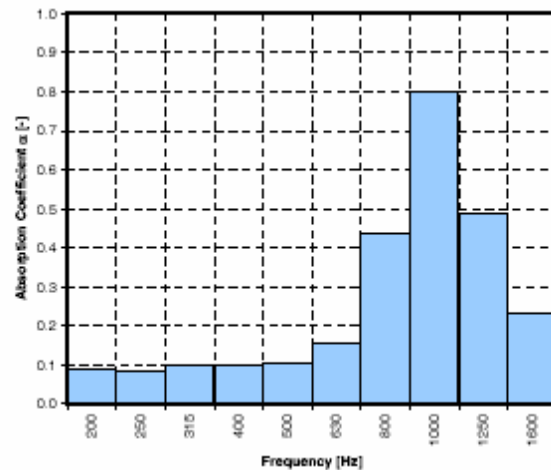

Figure 6.15: Sound absorption results from analysis of double-layer porous asphalt core sample (total core thickness: 85 mm; thickness of upper layer: 30 mm; stone size upper layer: max 11 mm; thickness of lower layer: 50 mm; Stone size lower layer: max 16 mm)



(a) Narrow-band frequency analysis

First absorption maximum	
$f_{\alpha,max}$	973 Hz
$\alpha_{max}$	0.87



(b) Third-octave bands

First absorption maximum	
$f_{\alpha,max}$	1000 Hz
$\alpha_{max}$	0.80

Figure 6.16: Sound absorption results from analysis of single-layer porous asphalt core sample (total core thickness: 85 mm; thickness of porous layer: 50 mm; stone size: max 16 mm)

The results indicate that both surfaces have acceptable sound absorption properties. However, it is observed that the DPAC has its peak at 600 Hz whereas the PAC has the peak at 1000 Hz. The measurements are only a rough indication of the sound absorption performance since the use of only a single core sample from each surface means that the statistical uncertainty is large; in addition the method measures sound absorption at an angle of incidence that is very different from actual conditions.





## **PART 3: SPECIFYING THE PERFORMANCE OF LOW-NOISE SURFACES**

### ***What should the surfaces do/be capable of doing?***

*It is important to be able to specify the performance of low noise surfaces in an accurate, transparent and reliable manner such that the methods gain acceptance and are widely used. This should encourage the specification of acoustically effective surfaces and facilitate the identification of failing surfaces. The methods should also assist in further developments and improvements.*

*For these reasons wherever possible the measurements and procedures used for specifying the acoustic properties of road surfaces and summarised in this Part of the manual are based upon standard and recognised methods.*

*The methods described for determining acoustical performance include the Statistical Pass-By (SPB) roadside measurements, the Close-ProXimity (CPX) tyre/road noise measurements as well as tests for sound absorption on absorptive road surfaces.*

*Also described are methods that are indirectly related to acoustic performance such as mobile and static road surface texture measurements and mechanical impedance.*

*An overview of the classification scheme is also described. This outlines the labelling procedure that should be adopted. This involves the determination of SPB and CPX values over a sample section of the road. Where CPX apparatus is not available the indirect methods of measuring surface texture, sound absorption and mechanical impedance can be employed.*

*In addition to classifying roads according to their acoustic performance, it is also important to ensure that the surfaces satisfy relevant standards for friction and safety, rolling resistance, low spray, etc. and are durable and economic.*



## 7 Overview of measurement methods for acoustic labelling and COP

Wherever possible, the measurements reported in this Guidance Manual are based upon standard, recognised methods. These methods are generally defined in international standards (ISO) and as such have also been used within the project to provide a firm basis for the proposed classification system for low-noise road surfaces described later in Chapter 9 and Appendix C. This Chapter of the Guidance Manual provides a short summary of the different methods. Further details of these methods are included in Appendix A. Certification procedures for the associated apparatus are described in Appendix B.

### 7.1 Direct measurements of acoustic performance

The following methods have been used within the SILVIA project for the direct measurement of road traffic noise or tyre/road noise:

#### 7.1.1 Statistical Pass-By (SPB) measurements

The statistical pass-by method, defined in ISO 11819-1 [26] was developed to assess the road surface influence on road traffic noise. The method involves measurement of the maximum pass-by noise level (together with the speed) of individual vehicles in different categories in a traffic stream at a microphone position located at the roadside.

In addition to applying the standard method, work has also been carried out within the project to investigate the repeatability and reproducibility of the measurement method and the influence of microphone height and vehicle classification on measurement results. Details of the findings from these investigations are summarised in Appendix A.

#### 7.1.2 Close-proximity (CPX) tyre/road noise measurements

The Close Proximity method (CPX method) as defined in the draft ISO 11819-2 [113] is designed to complement the SPB method as a means of assessing the acoustic properties of road surfaces. The method involves the measurement of rolling noise at microphone positions located close to the tyre contact patch. Measurements are normally taken at two positions using a standard tyre. The microphones and test wheel are generally mounted on a specialist vehicle/trailer and shielded by an enclosure to provide screening from wind and extraneous traffic noise.

In addition to applying the method, work has been carried out as part of the SILVIA project to study the relationship between CPX and SPB measurements. The repeatability and reproducibility of the measurement method has also been investigated via a Round-Robin test of some of the different CPX measurement systems used within different EU Member States. Details of the findings from these investigations are summarised in Appendix A.

## 7.2 Measurements of indirect acoustic performance and other parameters

The following methods have been used within the SILVIA project for the indirect measurement of acoustic performance and the measurement of other non-acoustic parameters:

### 7.2.1 Sound absorption measurements

Porous road surfaces exhibit important acoustical properties that affect (mainly reduce) the generation and propagation of the rolling noise of road vehicles and also suppress the propagation of propulsion noise. Although the interaction with the rolling noise generation and the propagation process are rather complex, it has been found that for most practical purposes, the normal incidence acoustic impedance of the surface can be used as a means for determining the relative acoustic benefits. The energy loss during reflection, referred to as acoustic absorption, is used as the describing feature.

Although several recognised methodologies are available for the measurement of the normal incidence absorption coefficient of porous and semi-porous road surfaces, e.g. assessment of core samples in an impedance tube according to ISO 10534-2 [114], the work in SILVIA has concentrated on taking measurements using the non-destructive, in-situ Extended Surface Method as defined in ISO 13472-1 [115]. This method can be applied under static conditions or potentially, dynamically whilst towing the measurement apparatus.

Formulations have been derived within SILVIA for predicting the Expected Pass-By Noise Level Reduction ( $ENR_{\alpha}$ ) due to sound absorption and for expressing the absorption performance of a surface as a single number rating for labelling and conformity-of-production purposes [116]. The repeatability and reproducibility of the measurement method has been investigated via a Round-Robin test of absorption measurement systems used within different EU Member States and the validity of using the method under dynamic conditions studied. Details of the findings from these investigations are summarised in Appendix A.

### 7.2.2 Road surface texture measurements

The texture of a road surface is considered to be the most important intrinsic parameter of a road surface influencing the generation of tyre rolling noise. Texture wavelengths of about 0.5 mm to 500 mm are relevant for the (interior and exterior) noise emission. Consequently, measurements of the texture wavelengths of some road surfaces can be used as a means of predicting their acoustic properties.

Measurements of the road surface profile are taken using laser profilometers using either static or mobile systems and a series of international standards have been produced for this purpose: ISO 13473-1 [117], ISO 13473-2 [118], ISO 13473-3 [119] and draft ISO 13473-4 [120]. Formulations have been derived within SILVIA for predicting the Expected pass-by Noise level Difference ( $END_T$ ) due to the variation in texture of a road surface [121]. The repeatability and reproducibility of the measurement method has also been investigated via a Round-Robin test of static and dynamic texture measurement systems used within different EU Member States (see Appendix A).

## 8 Overview of additional methods used in the SILVIA project

This section of the Guidance Manual provides a summary of methods that have been used or considered during the project that are not standard methods, because they do not conform to or are controlled recognised international standards, e.g. ISO, and/or they (together with associated specialist apparatus) have been developed as part of the SILVIA project. Detailed descriptions of these methods are included in Appendix A.

Further development and investigation into these methods and systems is required for them to be suitable for wider use, outside of an R&D environment, and as potential tools for use in the procedures defined within the proposed classification system for low-noise road surfaces described in Chapter 9 and Appendix C.

### 8.1 Mechanical impedance measurements

For conventional road surfaces, the stiffness as characterised by the mechanical impedance is generally not regarded as an important parameter, since the variation between surface types is small and the values are estimated to be orders of magnitude higher than the typical values found for vehicle tyres. However, with the continuing development of elastic pavements such as the poro-elastic surfaces described in Sections 6.1.2 and 6.4.2, there is a growing need to establish the in-situ stiffness characteristics of these types of road surfaces.

Measurements of the dynamic stiffness of a road surface can be taken by applying an impact to the road surface and registering the response of the material in terms of its vibration. There is no standard procedure for this type of measurement, so a method and test apparatus have been developed directly within the SILVIA project [122]. The method allows the measurement of the vibration response of the surface directly in line with the point of impact. Further research is needed to gain an understanding of the mechanisms involved and for the method to be suitable for wider use. However with the developments being made in elastic pavements, indicative procedures using this method have been included in the classification system in Appendix C although these have not been fully validated at the present time.

### 8.2 Rolling resistance measurements

Low rolling resistance is one of the informal requirements imposed on modern tyres as a result of economic and environmental considerations. The rolling resistance directly influences the fuel consumption of a vehicle and therefore has an impact on the emissions of CO<sub>2</sub>, an important greenhouse gas, and other pollutants.

The rolling resistance of a tyre can be measured either on the road or in the laboratory, although only road-based measurements give a good indication of the influence of the

road surface. Various road-based methods can be used which measure the force required to tow the tyre at a constant speed, but all have inherent difficulties. As part of the SILVIA project, TUG have tested a purpose-built trailer for measuring rolling resistance [32] which, with further development is hoped to be suitable for routine use.

### **8.3 Airflow resistance measurements**

In this case, airflow resistance refers to the passage of air through a porous road surface. It is anticipated that the measurement of airflow resistance may offer an alternative to the Extended Surface Method of ISO 13472-1 for characterising the acoustic absorption of porous surfaces.

The determination of the effective air-flow resistance is carried out according to the method described in ISO 9053 [123], although it is recommended to use the “comparing method” proposed by Stinson and Daigle [124], which is a variation of the method described in the ISO standard. Apparatus has been developed and tested independently of the SILVIA project which is suitable for in-situ testing. Further research is required for the method to be suitable for routine use.

## 9 Proposals for a noise classification procedure

This section of the Guidance Manual provides an overview of the classification system that has been developed within the SILVIA project as a proposal for a system for the acoustic labelling of low-noise road surfaces. A complete description of the proposal is included in Annex C of this Guidance Manual and in the SILVIA Project Report by Padmos *et al.* [199].

### 9.1 Reasons behind the need for a classification system

The acoustic performance of road surfaces is presently assessed differently in the individual Member States of the EU. This makes it difficult to compare the acoustic performance of different surfaces and therefore end users may not be fully aware of the options and relative benefits available. The absence of a common approach to the assessment of performance also makes it difficult for suppliers to operate in markets outside of their own country. The provision of a harmonised classification system for road surfaces would help to overcome these problems.

Clearly, a noise classification system for road surfaces must be adaptable in satisfying the needs of the various stakeholders who would benefit from such a system. The main stakeholder groups and their requirements may be summarised as follows:

- *Decision makers* involved in the planning process, and *politicians* at local, regional and governmental level often wish to specify the type of road surfaces that will be used under certain circumstances. These choices need to be well informed in order to make good decisions, so a standard method of classifying the acoustic performance of road surfaces is required, which is capable of taking account of local conditions;
- *Contracting parties* need a classification system for different purposes. Suppliers require a recognised method of assessment for promoting the acoustic properties of their road surfaces during the tendering process. Purchasers, on the other hand, require a standard method for the purposes of contractual verification;
- *Environmental Officers* require a method of predicting traffic noise for assessment purposes and will be responsible for developing future noise maps and action plans under the Directive for assessing environmental noise [9]. This will be done, initially, using existing interim methods but eventually the EU noise prediction method provided by the HARMONOISE/IMAGINE project will become available. This method requires as input the tyre/road source noise spectra for different vehicle categories relative to a reference surface at a given speed. (NB. The classification system described in Appendix C is empirically derived based on overall vehicle noise emissions. A method for converting this data suitable for input to the HARMONOISE/IMAGINE model is also included in Appendix D).

Clearly the demands on a classification system for assessing the acoustic performance of road surfaces vary significantly according to the requirements of the end-user. The sophistication of a computer model such as that being developed in the HARMONOISE/IMAGINE project may not be available/accessible to policy makers or contracting parties whereas environmental officers in the future may be obliged to use such a model when working according to the Directive.

In addition, it is noted that the only representative measurement for assessing the acoustic performance of road surfaces is the SPB (Statistical Pass-By) method [26]. However, this requires very stringent conditions which cannot always be achieved when assessing the acoustic performance of newly built roads. There is therefore a need for a system of labelling and COP assessment which will allow SPB levels to be associated with proxy measurements taken using other methods on a surface which can be especially laid at a suitable location. These proxy measurements can then be used to assess COP when SPB measurements cannot be carried out.

In recognising these significant differences, a classification system is proposed here that has been developed within the SILVIA project and that is tailored to the demands required by the various end-users described above. A complete description of the classification system is included in Appendix C of this Guidance Manual.

**It is important to note that this classification scheme is only a *proposal* and should not be interpreted as being legislative or mandatory procedures.**

## 9.2 Requirements for the classification system

To be fully effective, the classification system must satisfy the following general requirements:

- The system should be understandable, practical and cost-effective;
- It should be compatible with existing national noise prediction models and with the future EU noise prediction model provided by the HARMONOISE/IMAGINE project;
- It should be applicable for product specification, compliance testing and quality monitoring;
- It should be applicable for tendering and for assessing the Conformity of Production (COP);
- It should provide acceptable levels of reproducibility and repeatability.

Additionally, the following specific requirements are noted:

- For tendering purposes, it is essential that the classification system is robust to withstand juridical procedures and is commercially independent. Sufficient accuracy and tolerances have therefore to be formulated within the system and



procedures for assessing COP and in-service quality control over the lifetime of the surface must be clearly defined;

- Measurement methods and assessment within the system will be based on international standards which will make it possible to input the results into national methods and allow the acoustic performance of a road surfaces to be compared within each and across all Member States;

It should be noted that the results from the classification system will not be *directly transferable* to the HARMONOISE model because they do not separately identify the propulsion and tyre/road noise sources. Guidelines on modifying the results to be compatible with the required input to the HARMONOISE model are given in Appendix D.

### 9.3 Labelling procedures in the classification system

The classification system identifies specific measurement procedures necessary for labelling the acoustic performance of a road surface. These measurement procedures are described in Appendix A. There are two possible labelling procedures:

- LABEL1 (preferred): Assessment based on SPB and CPX measurements;
- LABEL2: Assessment based on SPB measurements and measurements of intrinsic properties of the road surface, e.g. texture and sound absorption.

Both noise labels are based on SPB measurements [26]. However, due to the limitations of the SPB method in assessing only a small section of a test surface, additional measurements to assess the acoustic performance over the full length of the trial section is required. LABEL1 includes a direct assessment of noise over the entire length of the trial surface using the CPX method [113] and is the preferred method. LABEL2 allows for an indirect assessment based on measurements of the intrinsic properties of the surface which can be related to the generation and propagation of noise e.g. texture and sound absorption.

For the purposes of assessing conformity-of-production (COP), surfaces with a noise LABEL1 certification are to be assessed using the CPX method, whereas, surfaces with a noise LABEL2 certification are assessed according to the relevant measurement of the intrinsic properties of the surface used in deriving the noise label.

Table 9.1 summarises the recommended method of assessment for noise labelling and Table 9.2 summarises the recommended method for assessing COP.

Table 9.1: Recommended labelling system for assessing the acoustic performance of different types of road surfaces: Determining the noise label

Label Identification	Method of assessment for different road surfaces		
	Dense Graded	Open Graded	
	Rigid <sup>1</sup>	Rigid	Elastic
<b>LABEL1</b> (Preferred)	SPB	SPB	SPB
	CPX	CPX	CPX
<b>LABEL2</b>	SPB	SPB	SPB
	Texture	Texture	Texture
		Absorption	Absorption
			Mechanical Impedance

<sup>1</sup>Rigid surfaces are defined as normal asphalt (dense and open graded) and concrete;

Table 9.2: Recommended labelling system for assessing the acoustic performance of different types of road surfaces: Assessing COP

Label Identification	Method of assessment for different road surfaces		
	Dense Graded	Open Graded	
	Rigid <sup>1</sup>	Rigid	Elastic
<b>LABEL1</b> (Preferred)	CPX	CPX	CPX
<b>LABEL2</b>	Texture	Texture	Texture
		Absorption	Absorption
			Mechanical Impedance

<sup>1</sup>Rigid surfaces are defined as normal asphalt (dense and open graded) and concrete;

Full details of the procedures for determining noise label values, the criteria and tolerances for assessing COP and advice on monitoring are included in Appendix C.

Appendix D describes the procedures for deriving, from the SPB noise level labels, the road surface corrections required as input to national prediction models. In addition, Appendix D includes procedures for estimating road surface correction within the HARMONOISE source model using SPB noise level labels.

It should be noted that the proposal for the classification system is only concerned with the performance of the surface when it is *newly laid* and not how it should perform over

time. The durability of the surface will be dependent upon local conditions and other factors and therefore cannot easily be routinely specified on a Europe-wide basis. Furthermore, the lifetime performance of a surface can be specified in a number of ways, e.g. X dB(A) reduction per year, total reduction of X dB(A) before replacement, etc. It was not feasible to propose a standard definition that was considered appropriate for all surfaces.

Application of the proposals concerning routine monitoring will provide information on the durability of these low-noise surfaces; this is particularly important for new designs of surface. When the classification system is applied to existing surfaces (which still requires that test sections be laid, although these will be based on existing material and structural specifications) the surface contractor may already have sufficient information on durability of the surface to allow lifetime criteria to be stated as an additional component of the classification label.

## 9.4 Examples of existing national road surface classification and/or procurement systems

Although there is currently no type approval/classification procedures that apply across the whole of the European Union, there are some existing recognised national procedures that are, in principle, similar to some of the components in the proposed SILVIA system. The following are examples of systems within Europe:

- **Netherlands:** “Methode Cwegdek” [125] is used to calculate a label,  $C_{wegdek}$ , for a surface; this is then used as a surface correction in the Dutch road traffic noise calculation scheme. The determination of  $C_{wegdek}$  is a mandatory requirement.  $C_{wegdek}$  can be specified for a type of surface, e.g. thin layers, porous asphalt, or for proprietary surfaces, e.g. “Twinlay” manufactured by Heymans. The label is derived from SPB measurements, but CPX measurements are also taken. The label is sometimes used for procurement purposes, but surfaces are traditionally procured based on technical specifications (aggregate size, etc). Either SPB or CPX measurements can be used for COP assessment. It is noted that COP assessment is sometimes a contractual requirement but not generally widespread; one exception is the recent Dutch subsidiary programme on silent road surfaces, where COP assessment was mandatory. Any monitoring programmes are currently only carried out for scientific purposes;
- **United Kingdom:** The HAPAS (Highways Agency Product Approval Scheme) scheme [108] includes an optional noise classification test for labelling and procurement purposes. The label data, expressed as an RSI (Road Surface Influence) value for a specific category of road is derived from SPB measurements. The scheme does not include any assessment of COP when a procured surface has been laid or any form of monitoring;
- **Germany:** The value DStrO (“Korrektur für unterschiedliche Straßenoberflächen”, “correction for different road surfaces”) is used in the German road traffic noise prediction model RLS-90 (“Richtlinien für den Lärmschutz an Straßen”, Guidelines for noise protection along roads”; [126] as a correction factor for different noise emission from different road surfaces. Additional corrections have

been subsequently issued [127]. The reference surface is non-grooved, poured asphalt. Other surface types such as SMA or open porous asphalt have defined DStrO-values expressed as integers in dB(A). The evaluation of the DStrO-values is formalised and is based on SPB measurements of passenger cars at a speed of 120 km/h [128]. The RLS-90 is used only for planning new roads or for the extension of existing roads. The method does not include any assessment of COP when a procured surface has been laid or any form of monitoring.

However, there is an example of a system which addresses both the classification and procurement of low-noise surfaces, as follows:

In Japan a classification and procurement system for low-noise road surfaces has been in use for several years, the first tests being carried out as early as 1998-99. The performance of the surface is based on prescribed tyre/road noise levels. In some cases, price and construction method is also considered.

The tyre/road noise levels are measured using a special van, a "Road Acoustic Checker", fitted with a fifth wheel taking measurements in a similar to the CPX approach. The test tyres have a special tread pattern designed to excite both vibrational impact and air-pumping mechanisms. Five of these vans are currently in use in Japan; the performance of these is regularly assessed by taking measurements on a series of reference surfaces (DAC 0/13, PAC 13 (20% voids), DPAC 5+13 (23% voids) and a poro-elastic surface) which are kept under cover when not being used for testing. The difference between vehicles on each surface must not deviate by more than a specified value.

Following the procurement of a road, tyre/road noise levels are measured twice; the first time soon after the surface is constructed, the second time one year after exposure. In each case, the measured levels must not exceed specified limits (89 dB when new, 90 dB after 1 year, based on the procurement of single or double-layer porous asphalt).

A special version of the procurement system is in place to encourage development of surfaces which are quieter than the normal requirements. In this case a road contractor specifies/promises a lower noise level for the surface than that specified above and the level immediately after construction must not exceed this. One year after completion, an increase of 1 dB is allowed.

By the end of 2003, a total of 278 contracts had been awarded using this procurement system, with the required noise levels being met for all except one contract. Approximately 10% of the projects encouraging quieter surfaces did not meet the promised levels.

## **PART 4: QUANTIFYING THE BENEFITS OF LOW-NOISE SURFACES**

### *What are the costs and advantages?*

*The overall benefits of low noise surfaces need to be evaluated not only in terms of noise reduction but also account needs to be taken of the likely effects on road safety, sustainability and maintenance costs.*

*A brief overview is provided of the safety aspects of low noise road surfaces, with particular emphasis on porous asphalt. The open structure of porous asphalt drains water from the road surface and reduces thermal conductivity. These characteristics may potentially impact a number of factors including driver visibility in wet weather, braking distances and winter maintenance.*

*The sustainability issues considered when changing to a low noise surface such as porous asphalt include the effects on water pollution, material use and recycling and fuel consumption.*

*An overview of a cost-benefit analysis method is presented that allows different noise-control measures to be evaluated including road surfaces, noise barriers and noise-reducing windows. The analysis method can account for variable noise-reducing effects over the life cycle of the project. The main focus of the method presented here is on noise benefits and road surface costs both in terms of investment and maintenance.*



## 10 Safety and sustainability benefits of low-noise surfaces

The safety and sustainability issues have been described in the SILVIA Project Reports by Elvik and Greibe [129] and Veisten and Saelensminde [130]. This part of the manual provides a summary of this work.

### 10.1 Safety aspects of low noise road surfaces

Road safety is a complex subject and accident rates are determined by a large number of factors. The principal contribution of the road surface to safety is in the provision of appropriate levels of skidding resistance, particularly in the wet. General relationships between road surface skidding resistance and accident rates have been reported by some workers albeit at a national level and with no differentiation between surface type [131].

Most dense asphalt low-noise road surface can be expected to exhibit a similar skidding resistance performance to their noisier counterparts as the physical mechanisms are similar. However, porous asphalt differs from ordinary dense asphalt concrete in having an open structure with approximately 20-25% air filled pores. The open structure of porous asphalt allows water to drain rapidly through the surface layer and reduces thermal conductivity. These characteristics of porous asphalt can have an effect on skidding resistance.

Porous asphalt has been used on roads since the mid 1980's. It is currently regularly used in The Netherlands, Belgium, France, Austria and Italy. Porous asphalt has been used particularly on motorways. Although the main reasons for its use include its ability to reduce traffic noise there are other benefits related to the rapid drainage characteristics of the surface. During heavy rainfall, water is not accumulated on the road surface but drained away. With less water on the road surface, splash and spray is reduced, visibility is improved and the risk of aquaplaning can be greatly reduced. This, in turn, enables the traffic capacity of the road to remain at a relatively high level. In addition, light reflection from water accumulated on a porous road surface is less than on a conventional non-porous road surface.

Although the rapid drainage effects would indicate that there are potential safety benefits that can be attributed to porous asphalt, the actual safety performance is not clearly understood. To provide some insight, a systematic review of relevant studies was commissioned as part of the SILVIA project.

#### 10.1.1 Accident reduction

A search has been made for studies that have evaluated the effects on road safety of porous asphalt [129]. A total of eighteen estimates of the effects on accidents of porous asphalt have been found, derived from six studies. These estimates proved to be highly inconsistent. Ten estimates indicate a reduction in the number of accidents. Eight estimates indicate an increase of the number of accidents.

Not all studies stated accident severity. In some studies, it is clear that estimates of effect refer to injury accidents. All studies are methodologically poor and have not included adequate control for important confounding factors, such as long-term trends or regression-to-the-mean. Regrettably, no studies provide original data that would enable a re-analysis to be performed.

The size of the accident sample is, in some studies, quite large and allows for the statistical estimation of even rather small effects, such as a 10% change in the expected number of accidents. On the average, however, the effects attributed to porous asphalt were smaller than this.

On the whole, the review of studies that have attempted to estimate the safety effects of porous asphalt has been very disappointing. Only a few studies were found, and none of these provided a methodologically satisfactory estimate of effect.

Unfortunately, predicting the likely effect on accidents of a particular measure is notoriously difficult. Accidents tend to be relatively few making statistical inference derived from accident data uncertain unless very long time scales can be employed. Also accidents usually result from a combination of factors which may or may not include factors related to the quality of the road surface. Again this can obscure the benefits that might be attributed to a particular measure. There are also other factors that need to be considered that relate to the design of the study. If the study of accidents involves some sort of before and after study, there may be problems associated with a phenomenon known as regression to the mean. For example, if accidents occurring prior to the installation of a new surface were unusually high, then a lower accident rate following installation would tend to be overestimated.

In order to try to overcome some of these difficulties, estimates of the effect on accidents of porous asphalt were summarised by means of a meta-analysis. As part of this analysis, a critical assessment of study quality was made and a score for study quality developed. The following criteria were used in the assessment of study quality:

- The specification of the road surface conditions to which estimates of effect apply;
- The specification of the severity of accidents to which estimates of effect apply;
- The extent to which a study controls for confounding factors that may influence estimates of the effects of porous asphalt;
- Whether a study has used appropriate statistical techniques to analyse data.

It was considered that the meta-analysis was well suited to the study since it can be applied when there are many estimates of the effect but the individual estimates vary.

Overall it was found that the estimates of the effects on accidents were all close to zero, and few of the summary estimates of effects were statistically significant. Hence, no statistically significant effect on road safety of porous asphalt was found.



### 10.1.2 Effects on risk factors

An attempt was made to improve the estimate of the safety effects of porous asphalt, by reviewing studies of the effects of porous asphalt on various risk factors associated with accident occurrence rather than using reported accidents alone.

A number of risk factors may be affected by the use of porous asphalt due to its open structure. These are:

- Driving speed;
- Visibility in wet weather;
- Light reflections;
- Stopping distance;
- Performance in wintertime;
- Rutting.

The effects of wet weather on driving speeds on porous asphalt and dense asphalt have been compared. A study reported by Nicholls and Daines [132] showed that car drivers appear to reduce speed in wet weather by 10 km/h on dense asphalt (from 126 to 116 km/h) whereas the corresponding reduction on porous asphalt was smaller at 7 km/h (124 to 117 km/h). However, in a study reported by Edwards [133] motorists' speeds in wet weather were reduced on average by 4 km/h compared with dry weather on both surface types. The average speeds were higher by 10 km/h on the porous asphalt surface under both dry and wet conditions. There are problems in obtaining reliable estimates due to the small lengths of the road sections in the Nicholls and Daines study and the difference in road width and traffic loading in the Edwards study. Hence there is a need for further studies of improved design before reliable estimates can be made of the effects of porous asphalt on traffic speeds.

Nicholls [105] showed that the spray on newly laid porous asphalt is reduced by more than 95%. Figure 10.1 illustrates this for a truck on a road section with and without porous asphalt. This benefit reduces with time, stabilising at a reduction of about a third after a period of between 5 and 10 years. Note that traffic noise was reduced initially by about 5 dB(A) compared with new rolled asphalt surfacings, diminishing to about 3 dB(A) after 8 years exposure to traffic.



Figure 10.1: Examples illustrating splash and spray from a truck driving on dense and porous asphalt respectively. [105]

Nicholls [105] concludes that subjective impressions, supported by photos, have indicated that reflections of light from oncoming vehicles or street lighting are reduced on wet porous asphalt compared to wet dense asphalt concrete. In addition road markings, etc., are more visible.

Delanne *et al.* [134] evaluated skid resistance and stopping distance on porous asphalt compared to dense asphalt. No differences in stopping distances were found between the two types of asphalt. Nicholls [105] shows that the sideways force coefficient 3 weeks after opening for porous road sections was the same as for dense asphalt. However there is evidence that new porous asphalt has lower skid resistance values when braking with locked wheels. When braking hard, the thicker bitumen layer on porous asphalt can 'melt' and becomes slippery, which leads to braking distances that are 20-40% longer than on dense asphalt [39]. The bitumen layer is worn away after 36 months (longer when modified bitumen is used). In order to warn drivers of this phenomenon, signs warning of slippery roads have been used.

The performance of porous asphalt during winter is described by Bonnot [135], Nicholls and Daines [132] and Norrtrts [87]. Since porous asphalt contains more moisture and salt tends to disappear into the voids there is a need for greater salt application expected to be 25-100%. Due to the lower thermal conductivity of porous asphalt, the road surface temperature drops below the freezing point earlier than on dense asphalt concrete. The temperature also stays below the freezing point longer if the air temperature rises above the freezing point, especially if the air temperature is close to the freezing point. Bonnot [135] shows statistics from French motorways indicating that the road surface was covered by ice 1-6% of the time on porous asphalt, compared to only 0.5-1% of the time on dense asphalt. The overall conclusion is that porous asphalt is more prone to be covered by ice in winter than dense asphalt and that more salt is required under such wintertime conditions.

Surface unevenness such as rutting can lead to a safety problem especially if water is prevented from draining off the surface with the consequent increase in the risk of aquaplaning. Unexpected unevenness or roughness can lead to dangerous situations and manoeuvres or even loss of control. It has been found that porous asphalt is in general much more resistant towards rutting than dense asphalt concrete. In one study a deformation of 2 mm occurred initially but then less than 0.5 mm per year on average after

8 years [105]. When a porous asphalt road section is nearly worn out (after 8-12 years) the observed deterioration is typically ravelling. Even though the ravelling process can start very suddenly and continue rapidly, it will only in very severe situations affect road safety.

Ragnøy [136] has assessed the combined effects of porous asphalt in terms of aquaplaning, splash and spray, wet road surface friction and light reflection. He concludes that porous asphalt influences all these risk factors favourably. A potential reduction of wet weather accidents of 9.5% in daytime and 13.6% at night was estimated. These estimates were based on the assumption that there are no adverse effects of porous asphalt, for example in terms of higher speed.

In Table 10.1, an attempt has been made to summarise current evidence on the effects of porous asphalt on various risk factors.

Porous asphalt has a favourable impact on splash and spray, on rutting and evenness, and on reducing light reflection from the road surface. There is no significant effect on stopping distance on dry or wet road surfaces though the risk of aquaplaning is reduced. Performance in wintertime and the frequency of resurfacing are all adversely affected by porous asphalt. It has proved difficult to quantify the effects on speed reliably.

The net effect of these various impacts on risk factors is difficult to assess. It depends on the relative strengths of the various effects. If, for example, there is a modest effect on driving speed, the favourable effects on other risk factors may lead to a net gain in road safety. If, on the other hand, there are large increases in speed, and the first winter is long and severe, the net effect may be adverse.

*Table 10.1: The effects of porous asphalt on risk factors*

<b>Risk factors affected</b>	<b>Effect of porous asphalt</b>
Splash and spray - visibility in wet weather	Favourable
Risk of aquaplaning	Favourable
Rutting – evenness	Favourable
Light reflection	Favourable
Friction – stopping distance	No effect
Speed	Adverse*
Performance in wintertime	Adverse
Need for more frequent resurfacing	Adverse

\* Further studies required to confirm

The fact that the effects of porous asphalt on risk factors are so mixed and complex makes it impossible to predict any corresponding change in accident rate. This confirms the evidence from studies that have evaluated the effects on accidents directly, since these studies show highly varying effects, that on the average appear to be fairly close to zero (i.e. no change in road safety).

### 10.1.3 Low noise non-porous surfacings

A small survey was made of studies that discuss in general terms desirable characteristics of road surfaces, in particular whether there is trade-off between safety and noise abatement.

Providing good skid resistance can improve road safety and need not adversely affect traffic noise. ITALGRIP is an example of a non-porous road surface treatment which is primarily intended to increase road surface skid resistance but has been found to reduce traffic noise as well [137]. Descornet [138] concluded that it is possible to optimise the texture wavelengths of surfaces for microtexture and macrotexture such that performance is good in terms of skid resistance, splash and spray, light reflection and external noise. Hence for these optimised road surfaces there is no trade-off between skid resistance and traffic noise.

## 10.2 Impacts on sustainability

The impact of changing to a low noise surface such as porous asphalt is evaluated in terms of the effects on water pollution, material use and recycling and fuel consumption. The main focus has been on porous asphalt because it differed from ordinary dense asphalt in ways that may potentially have important sustainability impacts. The open-structure drains water from the surface and reduces thermal conductivity. Further the durability and maintenance features are different from dense asphalt. All this potentially contributes to different sustainability effects when substituting porous for dense asphalt.

### 10.2.1 Water pollution

James [139] describe the road pollutants (suspended soils, hydrocarbon and heavy metals), their sources (vehicle leakage, corrosion of crash barriers, deposition of exhaust products, de-icing products and herbicides, abrasion of tires and asphalt), and their possible negative impacts (a potentially detrimental effect on water ecosystems and possible contamination of drinking water). The impact of the pollutants will depend on traffic volume and the use of nearby waterways. But it may also depend largely on the extent to which these pollutants really reach the waterways, and this movement may be influenced by the type of pavement. According to James [139] the runoff of pollutants from roads to rivers and streams can be greatly affected by a change from conventional (impervious) asphalt to porous (pervious) asphalt.

Laying porous asphalt can affect flooding (reducing spray and the “first flush” phenomenon) and draining (producing a filtration effect). Also, compared to conventional dense asphalt, Berbee *et al.* [140] and Pagotto *et al.* [141] argue that porous asphalt has an adsorption property allowing a more gradual runoff of water (limited peak flows and slower discharge) and a filtering effect.

Table 10.2: Relative reductions of pollutants in runoff water from porous roads

Pollutant	Minimum	Average	Maximum
Total suspended solids	81%	<b>87%</b>	91%
Total Kjeldahl nitrogen	0%	<b>42%</b>	84%
Total nitrogen content		80%	
Total phosphorous content		68%	
Total organic carbon		82%	
Total hydrocarbons / oil	92%	<b>96%</b>	98%
Polynuclear aromatic hydrocarbons	95%	<b>95%</b>	95%
Lead	74%	<b>82%</b>	92%
Copper	35%	<b>47%</b>	67%
Cadmium	17%	<b>58%</b>	88%
Zinc	66%	<b>79%</b>	90%
Chromium	80%	<b>84%</b>	88%
Nickel		80%	
Nitrates	0%	<b>23%</b>	69%
Ammonia	0%	<b>37%</b>	74%
Chemical oxygen demand	0%	<b>59%</b>	88%
Biochemical oxygen demand	82%	<b>82%</b>	83%

Sources: [139, 140, 141]

Table 10.2 displays mean estimates from these three references, giving average values of the three with minimum and maximum (of point estimates). The estimates of effects relates to short-term effects (approximately one year) on motorways.

The main potentially negative effect on water pollution from a change to porous asphalt is related to winter maintenance. According to James [139] the thermal properties of porous asphalt demands more extensive use of de-icing salting. This may have an adverse effect on runoff partly because of the increased concentrations of de-icing chemicals but also because of the increased secretion of heavy metals. However, the reported necessary increase in use of de-icer, relative to ordinary dense asphalt, varies considerably. The percentage increase in the frequency in applying de-icer varied from 30% to 100 % and the quantity of de-icer from 30% to 450%.

Thus, in the short-term there may be positive effects on runoff (absorption and filtration) and negative effects from de-icing. The run-off effect may be considered more important in areas that combine exposed watersheds and high populations / high traffic volumes. The de-icing effect may be considered more significant in the cooler areas especially the Nordic countries and the mountainous areas of Continental Europe.

There are obviously extra costs related to an increased use of de-icing chemicals apart from any costs associated with environmental effects. Also the absorption and filtration of pollutants may involve extra maintenance costs. James [139] discusses the possibility of treating water applied to cleaning of the asphalt pores, and, if the water is filtered,

disposing the filtrate as chemical waste. This treatment should of course, be seen in relation to re-instating the noise-reduction properties of the surface. On highly trafficked, high-speed roads, cleaning may not be necessary due to the self-cleaning action of the tyres from the effects of air-pumping, but then an extra cost may appear over a longer time span. Eventually, the contaminants stored within the road surface structure will need to be considered when the road surface is replaced. If the aggregate in the material is to be recycled then additional costs can be expected in cleaning the aggregate and safely disposing of the contaminated material.

James [139] also remarks that the drainage properties of the porous asphalt contribute to reducing the amounts of airborne pollutants from roads, and that the thermal properties of porous asphalt may reduce eventual problems of warmed water leaking into rivers with salmon and trout. Further, due to the reduced splash and spray with porous asphalt, the consumption of windscreen flushing and car washing is reduced. These effects have not been quantified.

### 10.2.2 Material use / recycling

Porous asphalt roads are currently found to have a shorter life span compared to conventional dense asphalt [139]. An average estimated lifetime of porous asphalt, in the Netherlands, has been found to be 10 years, compared to 12 years for dense asphalt [142]. The surfacing layer of porous asphalt also needs to be thicker, for noise-reduction purposes. Further, porous asphalt may be more prone to ravelling and therefore will need more maintenance such as sealing and repaving. This will require more aggregate and binder and more energy use.

It may be considered that the potential for recycling is lower for porous asphalt, due to the accumulated detritus and contaminants in the pores. For example the accumulation of pollutants like heavy metals and PAHs in the worn porous pavement could impede recycling since it may need to be handled as special waste. Descornet *et al.* [143] find that the quantities of pollutants in worn porous asphalt are generally relatively low. For eventual dumping the worn porous asphalt could be allowed at class II sites in any region of Belgium, without cleaning. However, it seems possible to recycle a large share of worn porous asphalt, although possibly to a slightly lesser degree than for dense asphalt types. Pucher *et al.* [144] estimates an average recycling rate of roughly 80% or higher for dense asphalt and 50-80% for porous asphalt.

In summary, with current technologies, the use of porous asphalt instead of dense asphalt may involve

- More material use in surfacing and resurfacing;
- A lower degree of recycled material,
- More use of energy/transport in repairing, eventual cleaning, and eventual dumping;
- Eventual additional activity/care (involving energy, transport, etc) in waste handling.

However, regarding the last point on waste handling, it should be emphasised that there is a higher direct outflow of pollutants in runoff from dense asphalt surfacing.

### 10.2.3 Fuel consumption

In order to investigate the possible effect of road surface effects on rolling resistance and hence fuel consumption a systematic international literature survey has been conducted [33].

It was found that the road surfaces can be responsible for nearly a doubling of the rolling resistance, and this has an influence on the change of fuel consumption of approximately 10%. Therefore the type of road surface and the maintenance standard of the surface are important for the rolling resistance as well as the fuel consumption.

Under urban driving conditions (speed 40-60 km/h) with an uneven driving pattern, small changes in the rolling resistance of a pavement has only marginal consequences for the fuel consumption and therefore also on the emissions. But under driving conditions with a constant speed on a road with no gradient (typically driving on highways at higher speeds), changes in the rolling resistance of the pavement have an important influence on the fuel consumption and the emissions.

It seems that the unevenness of pavements as well as the megatexture (texture wavelengths of 50 mm to 0.5 m) is the most important for determining the rolling resistance and by this the fuel consumption of different pavements [31]. The macrotexture (texture wavelengths 0.5 mm to 50 mm) also has a significant effect but seems less well correlated with rolling resistance. When noise reducing pavements are designed it is basically the macrostructure and the porosity that are optimized. Often relatively small chippings are used to produce a very smooth pavement surface which implies that such surfaces may produce some beneficial effects on rolling resistance.

Generally the presence of water or snow on a road increases the rolling resistance and therefore the fuel consumption. On porous pavements the rain water is drained away from the road surface leaving it dry for longer periods than dense pavements. Thus it would appear that that under these conditions porous pavements have a positive effect on rolling resistance and consequently on fuel consumption.

It should be noted that no specific data for the effects on rolling resistance of porous pavements and other noise reducing pavements were retrieved from the literature search. There is generally therefore a need for measurements of rolling resistance on noise reducing pavements. In addition it was noted that most research in this field has been carried out on passenger cars and that there is a lack of knowledge for trucks and other heavy vehicles.

Measurements of rolling resistance have been carried out within SILVIA using a specially designed trailer [32] (details of the measurement method are included in Appendix A). Figure 10.2 illustrates the rolling resistance on a series of standard and low-noise pavements relative to that on DAC 0/16 for (a) a patterned tyre and (b) a slick tyre at a rolling speed of 70 km/h. The blue bars in the Figure denote measurements that were taken on damp surfaces.

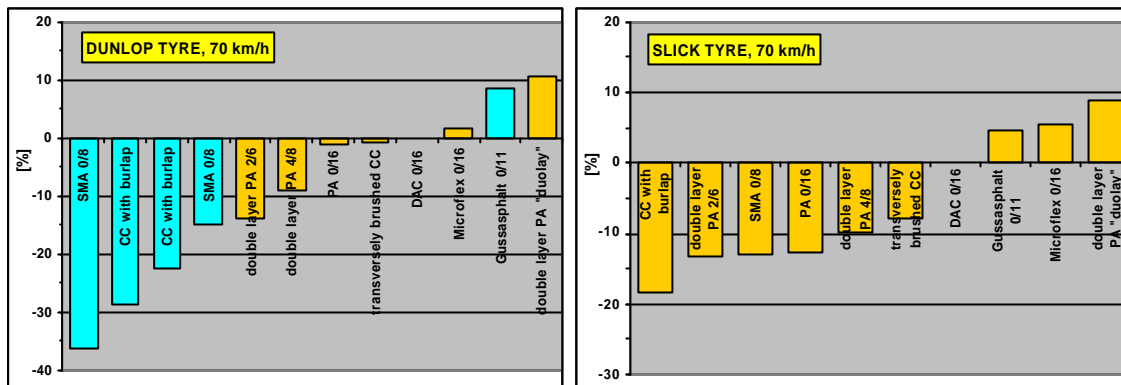

(a) Dunlop SP30 175/65 R14 82T patterned tyre

(b) Continental 175/65 R14 82T slick tyre

Figure 10.2: Rolling resistance on standard and low-noise surfaces relative to DAC 0/16



# 11 Cost benefit analysis

## 11.1 Introduction

A method for assessing the costs and benefits of low noise road surfaces has been developed as part of the SILVIA project [145]. It has been designed to assess primarily the costs of construction and maintenance of low noise pavements and benefits, expressed in monetary terms, related to the reduction in noise levels achieved with different surfaces.

The method is designed to be sufficiently flexible to handle different noise-control measures, including an ability to account for changes in the acoustic performance over time. This is, of course, important when considering the benefits provided by road surfaces. It has been noted earlier that the effects of trafficking and weathering can affect the noise reducing characteristics over time. It is also able to analyse cases where speed is affected and, with such speed changes, how this might affect safety, fuel consumption and air pollution.

This chapter provides a summary of the analysis framework that has been developed. Further detailed description can be found in the appendix "Conversion of costs and benefits to monetary terms" which is based on the SILVIA Project Report by Saelensminde and Veisten [145].

The description and explanation of a spreadsheet for cost-benefit analysis is presented here accompanied with extracts from an example spreadsheet where Norwegian data has been applied as default values.

## 11.2 Description of the calculation method

Attached to this manual is a CD containing an Excel spreadsheet that can be applied for noise-control options but primarily an assessment of the economic effect of changing to a road surface with different noise characteristics. A brief outline of the approach to calculation and the use of inputs is given in this section.

In general terms the spreadsheet consists of an input-result (output) page and two pages with (underlying) calculations for two road surface alternatives plus some general calculations.

The two surface alternatives are given in the following forms:

- 'Alternative 0' represents the current situation without alteration (i.e. "business as usual" / "do nothing"), e.g. a standard dense asphalt that is not optimised with respect to its noise characteristics;

- 'Alternative 1' is the improved situation with reduced noise levels, i.e. laying a surface that yields lower noise levels (compared to 'Alternative 0').

Of course, two pavements having "good" noise characteristics can also be compared by setting the best surface of the two as Alternative 1.

The noise benefits resulting from a change to Alternative 1 are calculated in two different ways. These are summarised in (a) and (b) below:

- (a) This method is based on marginal values per vehicle kilometre, involving both noise effects and any other indirect effects e.g. on air pollution, safety, etc. In this case the estimated noise benefits will depend on the "average marginal values", i.e. some average noise cost per vehicle kilometre in urban and/or sub-urban areas. Hence, in this case there is no specific reference to affected dwellings in the calculations. However, weighting factors can be applied to reflect differences in dwelling density. Principally, one could also include a factor for different use of the area, e.g., areas with shops/schools/workplaces and more residential areas where people are more likely to be affected by noise outside their homes. The calculation based on marginal values can take into account noise control options where speed is affected directly or indirectly, and with such speed changes the indirect effects on safety and air pollution;
- (b) This method is based on direct calculation of noise benefits from the reduced noise in dB(A) outside dwellings multiplied by the number of homes alongside the road section on both sides (affected dwellings) and further multiplied by the valuation per dB(A) decrease per dwelling (per year). The dB(A) valuation is weighted according to the reference point, i.e. the reductions from higher noise levels are valued higher. The valuation function is adapted from official Swedish numbers [146] and can be adjusted and approximated to the monetary valuation of noise reduction in other countries.

In addition, alternatives involving noise control options other than road surfaces are included in the input-result page of the spreadsheet. 'Alternative 2' provide estimates for the use of noise barriers while 'Alternative 3' provides estimates for noise reducing windows (i.e. window insulation). Noise barriers and noise insulation may yield higher dB(A) reductions than low-noise surfaces, thus pushing up the monetary valuation. Even if noise reducing windows only provide noise reduction inside the dwelling, with lower reference dB(A) levels than *outside*, the same monetary valuation scale is applied indiscriminately between all three alternatives. However, noise barriers (Alternative 2) and especially noise insulation (Alternative 3) do not provide as wide an effect as noise reduction at the source (Alternative 1). Noise-reducing surfaces typically provide benefits over a wider area than noise barriers, e.g. vulnerable road users such as cyclists, and pedestrians in or close to the road may experience benefits. Furthermore, the use of noise-reducing surfaces will avoid any negative effects associated with noise barriers such as reduced view and increased shade. In the case of noise-reducing windows the reduced noise and noise benefits are only experienced indoors with closed windows. Thus, the monetary valuation is scaled down to 80% for noise barriers and 60% for noise reducing windows compared to the low-noise surface. This is an approximation to procedures presented by Larsen and Bendtsen [147].

With regard to the discount rate that is used, the EC-proposed social discount rate of 5% for large investment projects will be applied as the default [148] and upper value, while the

World Health Organisation's recommended social discount rate of 3% will serve as the lower value [149].

### 11.3 Example of CBA using the spreadsheet

The use of the proposed framework/spreadsheet is illustrated with Norwegian default data for replacing dense asphalt with porous asphalt on an urban ring-road with a speed limit of 70 km/h. The country, road type and speed are set at the beginning of the spreadsheet as shown in Figure 11.1.

Country	Norway
Road type	ring road
Speed	70

Figure 11.1: Scenario data entry in CBA spreadsheet

In the input section only **green fields** can be changed by the user, i.e., these are the cells in the spreadsheet where inputs can be entered. The **white fields** give calculations from other inputs. Some (potential) input areas are shown as **yellow fields**; these are not (currently) included into the model.

The input-output page consists of the following elements:

#### 1. General data for cost-benefit analysis:

The input section in the spreadsheet is shown in Figure 11.2.

Discount rate, %	5
Calculation period, yrs	10
Annuity factor	0.1233
Tax cost factor, %	20

Figure 11.2: General data entry in CBA spreadsheet

The default discount rate is based on recommendations from the European Commission. If low-noise pavements and other noise-control measures are to be regarded as "health projects" the WHO proposes a lower discount rate (3%), while if these are regarded as "road projects" the government of some European countries (e.g., Norway) may propose higher discount rates.

The choice of calculation period (project horizon) will affect the calculated present values, but it should not affect (at least, not considerably) the calculated net benefit or benefit-cost ratio.

A taxation cost factor adds a cost to the investment and maintenance, reflecting the "efficiency loss" of public financing and taxation.

#### 2. Transport cost data

The input section in the spreadsheet is primarily needed for the calculations for Alternative 1a (relative to Alternative 0), i.e. calculations based on marginal cost values. However,

monetary valuations of noise variation (reduction) are also indispensable in the calculations for Alternative 1b (direct calculation of noise benefits from the reduced noise) as well as for Alternatives 2 and 3.

The input section in the spreadsheet is shown in Figure 11.3:

(a) Data entry specific to Alternative 1:

Noise costs	Alternative 1a (& Alternative 0)	
	€/km light vehicles	€/km heavy vehicles
	0.006	0.060

(b) Data entry specific to Alternatives 2 and 3:

Noise costs	Alternatives 1b, 2, 3
	€ per dB(A) per household (approximated average)
	50.00

(c) Data entry relevant for all Alternatives:

Emission costs (€/kg)	NOX	CO2	VOC	SO2	PM10
	10.270	0.058	10.270	10.900	265.000

Time costs €/hour	Light vehicles	Heavy vehicles	Buses
	15.00	49.00	117.00

Accident costs €/km	Average speed (km/h)	Average accident costs
(See manual & calculation sheet)	60	0.075

Insecurity costs €/km	Average speed (km/h)	Average insecurity costs (best estimate)
(See manual & calculation sheet)	60	0.010

Vehicle operation costs €/km	Speed	Light vehicles	Heavy vehicles
	10	0.43	0.82
	20	0.23	0.51
	30	0.17	0.42
	40	0.15	0.40
	50	0.13	0.40
	60	0.13	0.42
	70	0.13	0.46
	80	0.14	0.52
	90	0.15	0.60
	100	0.16	0.70
	110	0.17	0.80

Figure 11.3: Transport cost data entry in CBA spreadsheet

Most of these values, for the majority of the countries involved in the SILVIA project, should be available from the ExternE project of the European Commission. Some values are also stated in "Conversion of costs and benefits to monetary terms" (see the Appendix in the report by Saelensminde and Veisten [145]). These transport cost data are relevant for the case when the noise-control measure affects time use, safety and emissions of pollutants. (These elements, with the exception of the noise valuation, could be disregarded if only noise levels are affected by the road surface change, noise barrier or noise-reducing window.) Note that the "insecurity cost" is difficult to quantify as it is associated with limiting choices for cycling and walking along a route due to the perceived threat posed by traffic. This is mainly related to the speed of traffic but could also include noise annoyance resulting from excessive noise exposure.

### 3. Area and traffic data

The input section in the spreadsheet is shown in Figure 11.4.

	All Alternatives	Alternative 1 (& 0)	Alternatives 1b,2, 3
Road length, km	1		
Road width, to be paved, m		16	
Dwelling density pr km			400
Typical building height (no.Storeys)			3
Dwelling average price, €			200000
Road width, total, meters	32		
Lanes, total (sum both directions)	4		
Share of studded tyres	50		
Adjustment factor (corresponding to dwelling density)	1.0		
	Alternative 1		Alternative 0
Speed, km/h	70		70
Average daily traffic, ADT	25000		25000
Share of heavy vehicles	0.0855		0.0855
Share of light vehicles	0.9145		0.9145
Share of busses	0.0233		0.0233
Share of trucks	0.0622		0.0622

Figure 11.4: Area and traffic data in CBA spreadsheet

The specification of the road length is essential for the project limitation; the default is set for a (typical or specific) 1 km section. The road width to be paved is essential for the calculation of road surface costs. The dwelling density is applied in the noise benefit calculations for Alternative 2 and Alternative 3, as well as for Alternative 1 in the case where no indirect effects on safety, air pollution or time consumption are taken into account.

As indicated above, some areas may be used more intensively during daytime, for shopping, recreation, school attendance, i.e. increasing the effect of noise and noise reductions. This could be weighted in the spreadsheet with an adjustment factor greater than 1.0. Dwelling density is the number of dwellings fronting the road on both sides of the road per km. Dwellings out to a maximum distance of approximately 100 m from the road can be included, when the buildings are only single two-storey houses along semi-urban roads or motorways. However, if the buildings adjacent to the road are buildings with more than two storeys (higher blocks of flats), then one may consider including only the dwellings in the first row of blocks.

The spreadsheet can handle traffic speed changes, either as a specific individual measure or in combination with pavement changes. This is for the calculation of Alternative 1 (and Alternative 0) when it will be expected there will be indirect effects on time use, safety and emission of pollutants (hence the input of transport cost data shown earlier). Traffic management restrictions affecting ADT or the share of heavy vehicles can also be included.

### 4. Pavement data

The input section for pavement data is split into two sections in the spreadsheet. The first section in the spreadsheet is shown in Figure 11.5.

Cost data, asphalt	Alternative 1		Alternative 0	
	Investment -	Lifetime (yrs)	Investment -	Lifetime (yrs)
Top layer, €/m <sup>2</sup>	8.00	4	12.03	8
Bottom layer (for two-layer pavements), €/m <sup>2</sup>	16.00	7	0.00	0
Drainage pipes, €/m	125.60	7	0.00	0
Recycling of old top layer, %	0.00		0.00	
Recycled material in new top layer, %	0.00		0.00	
Cost of recycled versus non-recycled A127top layer, %	90.00		90.00	
Shortest expected lifetime for top layer, yrs			4	
	Maintenance (€)	Cleanings per year	Maintenance (€)	Cleanings per year
Winter maintenance (de-icing), €/m <sup>2</sup> /year	0.64		0.42	
Cleaning of pavement, €/m <sup>2</sup>	0.08	2	0.00	0
Cleaning of pipes, €/m	3.14	2	0.00	0
Special waste handling of polluted water, €/km/year	0.00		0.00	

Figure 11.5: Pavement data (costs) entry in CBA spreadsheet

This section involves the input of asphalt cost data: investment costs, expected lifetime, and maintenance costs – with the possibility to vary the number of times the asphalt is cleaned per year (in the case of porous asphalts). The spreadsheet may also be developed to handle recycling and waste handling costs.

The second section in the pavement data part of the spreadsheet is shown in Figure 11.6.

Noise data, asphalt	Alternative 1		Alternative 0	
	dB(A)	km/h	dB(A)	km/h
Car pass-by noise at road side, at given speed	66	70	71	70
Noise emission at dwelling facade, dB(A) at given speed	69.5	70	74.5	70
Noise reduction first year, dB(A) (Alternative 1 vs. Alternative 0)			5	
Relative noise reduction per 10 km/h reduced speed (Alternative 1 vs. Alternative 0)			0.5	
Relative noise increase per yr, dB(A) (Alternative 1a vs. Alternative 0)			0.5	

Figure 11.6: Pavement data (noise) entry in CBA spreadsheet

Both car pass-by noise (for a given speed) and the noise exposure at the dwelling façade are entered. Some data for car pass-by noise, for most relevant road surfaces, is available from the SILVIA documentation. Using a suitable noise prediction model the calculation of noise exposure at the dwelling façade is determined from a number of factors including the traffic flow (ADT), percentages of light and heavy vehicles, distance of the road from the façade and topographical information. The resulting value on the  $L_{Aeq}$  dB scale is used in the calculation of monetary valuation.

For a given speed the difference between noise exposure at the dwelling façade in Alternative 0 and Alternative 1 is given for the first year (newly laid pavements) is given. This difference between Alternative 0 and Alternative 1 will generally decrease with speed as propulsion noise becomes relatively more important than rolling noise. In the default

example the dB(A) difference is assumed to decrease by 0.5 dB(A) per 10 km/h decrease in speed. The difference between Alternative 0 and Alternative 1 may also change over time as a result of, for example, the clogging of a porous surface. In the default example the dB(A) difference (noise benefit) is assumed to decrease 0.5 dB(A) per year – averaged over the different speeds. A full calculation table for a 10 year project period is given in the spreadsheet. Also included in the spreadsheet is the calculated average dB(A) difference between Alternative 0 and Alternative 1 over the project period, for various speeds.

## 5. Alternative noise reduction measures

The last section in the input section involves the specific inputs for noise barriers and noise-reducing windows. The input section in the spreadsheet is shown in Figure 11.7.

### Noise barrier - "Alternative 2" (combined with insulation in cases of buildings higher than two-storeys)

Investment cost (€/km)	726000
Maintenance cost (€/year/km)	2200
Expected lifetime, years	25
Noise reduction dB(A)	5
% reduction of the total noise annoyance problem (not reduction at the source)	80
Share of dwellings achieving noise reduction	66.67
Share of dwellings relevant for noise reducing windows	33.33

### Noise insulation (noise-reducing windows) - "Alternative 3"

Investment cost (€/dwelling)	5000
Maintenance cost (€/dwelling/year)	0
Expected lifetime, years	25
Noise reduction dB(A), indoors noise only	9
% reduction of the total noise annoyance problem	60

Figure 11.7: Alternative noise reduction measures data in CBA spreadsheet

Noise barriers are combined with noise reducing windows for the ring-road type road scenario, assuming that higher buildings are adjacent to the road than would be found in the freeway/motorway case. Additionally, as already stated, the effect of both alternatives are scaled down relative to tyre/road noise reduction from low-noise pavements

### 11.3.1 Outputs

The output section in the spreadsheet for cost-benefit analysis, shown in Figure 11.8, summarises the different options.

First, project costs are given for the different elements of pavement investment and pavement operation. Then the estimated marginal costs, relevant for the Alternative 1a calculation are provided.

Then the noise reduction from the three alternatives and the corresponding monetary valuations are provided.

**Project costs - road surfaces - € for given road length and road width (present value)**

Alternative	Investment (layer)	Investment (Drainage)	Maintenance (Winter)	Maintenance (Cleaning)	Maintenance (Clean pipes)
Alternative 0	316,554	0	54,485	0	0
Alternative 1	740,072	210,611	83,024	20,756	50,917

**Noise/environmental/accident/insecurity/time/veh.operation costs to society - marginal costs per vehicle km - € - Alternatives 0, 1a. (From calculation sheets 0 and 1a.)**

Alternative	Noise	Local air pollution	Global air pollution	Accidents	Insecurity	Time	Vehicle operation	Sum total	Speed km/h
Alternative 0	0.017	0.063	0.014	0.102	0.014	0.278	0.158	0.647	70
Alternative 1a	0.010	0.063	0.014	0.102	0.014	0.278	0.158	0.639	70

**Noise benefits to society (reduced noise costs) - calculated € value for estimated dB(A) change per household per year - Alternatives 1b, 2, 3**

**Alternative**

Alternative	Average noise reduction in expected life time - dB(A)	Noise benefits per dwelling per year
Alternative 1a	4.3	€ 789
Alternative 1b	5.0	€ 474
Alternative 2	9.0	€ 2,249

**CBA results - relative to Alternative 0 (that is, additional benefits and costs compared to baseline alternative)**

	Alternative 1a low-noise asphalt (benefits all effects) €/year	Alternative 1b low-noise asphalt (benefits noise) €/year	Alternative 2 barrier (plus ev. ins.) (benefits noise) €/year	Alternative 3 insulation (benefits noise) €/year
Benefits	70,880	315,713	426,212	899,781
Costs, investments	78,212	78,212	171,768	246,675
Costs, operations/maintenance	12,360	12,360	2,200	0
Tax-cost factor	18,114	18,114	34,794	49,335
<b>Benefits - Costs (net benefit)</b>	<b>-306,527</b>	<b>1,678,532</b>	<b>1,763,047</b>	<b>4,895,265</b>
<b>Benefit-cost ratio</b>	<b>0.65</b>	<b>2.90</b>	<b>2.04</b>	<b>3.04</b>
Net benefit-cost ratio	-0.35	1.90	1.04	2.04
Total project cost per dwelling		272	522	740
Project costs per dB(A) reduction per dwelling		64	104	82

Figure 11.8: Output section from CBA spreadsheet (Based on Norwegian data for an urban ring-road with a speed limit of 70 km/h)



For all of the alternatives, the benefits and costs of investment and operation/maintenance are then stated, together with the resulting net benefits. The benefits and costs are the additional benefits and costs relative to Alternative 0 (the situation with no low-noise pavement and no other noise control measures). Both present values (for the whole project or calculation period) and annual values (calculated using the annuity factor) are given. Both the benefit-cost and net benefit-cost ratios are listed. The additional project costs per dwelling and per dB(A) noise reduction are also given.

As explained above, for Alternative 1 two different benefit calculations are presented: One (Alternative 1a) applying measures per vehicle kilometres (marginal values), enabling the assessment of all potential effects on time use, safety, air pollution etc. The other (Alternative 1b) involves only the estimation of noise benefits based on the number of dwellings and their estimated valuation (willingness-to-pay) for a dB(A) reduction (this last calculation procedure is also applied for Alternative 2 and Alternative 3). Even if the calculation for Alternative 1a, in this example performed using Norwegian data, for a “ring-road” involves on effects on noise levels, the resulting estimates differ substantially. The implicit ADT and number of affected households (the number of dwellings adjacent to the road) cannot be read directly out of the Alternative 1a calculations, but these implicit figures may explain why the result is different from the locally adapted calculation for Alternative 1b. The latter calculation is directly comparable to the calculations for Alternatives 2 and 3, and in that respect the low-asphalt alternative is promising. Alternative 1b has a high benefit-cost ration and the lowest project costs per dwelling and dB(A) reduction.

As a further example of the application of the spreadsheet, calculations have also been carried out using data from Denmark and considering three different road types. The final benefit-cost ratios for these cases, together with that from the Norwegian example already shown in this Chapter are summarised below; the final output from each analysis is shown in Figure 11.9 – Figure 11.11 (the complete CBA spreadsheets for each case are included on the CD-ROM that accompanies this Guidance Manual).

*Table 11.1: Benefit-cost ratios (€/project) for different road types in different countries*

Noise reduction measure	Norway Ring-road 70 km/h	Denmark Ring-road 70 km/h	Denmark City street 50 km/h	Denmark Freeway 110 km/h
<b>Alternative 1a:</b> Low-noise asphalt (Benefits - all effects)	0.65	2.00	0.69	4.82
<b>Alternative 1b:</b> Low-noise asphalt (Benefits – noise)	2.90	3.16	4.91	4.90
<b>Alternative 2:</b> Barrier + ev. ins. (Benefits – noise)	2.04	1.16	N/A	3.31
<b>Alternative 3:</b> Insulation (Benefits – noise)	3.04	1.81	1.45	2.52

It should be stressed that these estimates are based only on example data and should not be considered as anything other an illustration of the how the CBA tool can be applied.

Project costs - road surfaces - € for given road length and road width (present value)												
Alternative	Investment (layer)	Investment (Drainage)	Maintenance (Winter)	Maintenance (Cleaning)	Maintenance (Clean pipes)							
Alternative 0	44,800	0	26,107	0	0							
Alternative 1	150,039	53,600	39,161	9,081	21,729							
Noise/environmental/accident/insecurity/time/veh.operation costs to society - marginal costs per vehicle km - € - Alternatives 0, 1a. (From calculation sheets 0 and 1a.)												
Alternative	Noise	Local air pollution	Global air pollution	Accidents	Insecurity	Time	Vehicle operation	Sum total	Speed km/h			
Alternative 0	0.016	0.044	0.009	0.042	0.007	0.281	0.102	0.500	50			
Alternative 1a	0.011	0.044	0.009	0.042	0.007	0.281	0.102	0.496	50			
Noise benefits to society (reduced noise costs) - calculated € value for estimated dB(A) change per household per year - Alternatives 1b, 2, 3												
Alternative	Average noise reduction in expected life time - dB(A)			Noise benefits per dwelling per year								
Alternative 1a	2.5			€ 222								
Alternative 1b	n.a.			n.a.								
Alternative 2	n.a.			n.a.								
Alternative 3	9.0			€ 864								
CBA results - relative to Alternative 0 (that is, additional benefits and costs compared to baseline alternative)												
Benefits												
	Alternative 1a low-noise asphalt (benefits all effects) €/year	Alternative 1b low-noise asphalt (benefits noise) €/project	Alternative 2 barrier (plus ev. ins.) (benefits noise) €/year	Alternative 3 insulation (benefits noise) €/project								
Costs, investments	20,647	167,401	147,385	1,194,974	n.a.	n.a.	n.a.	n.a.	574,803	4,660,399		
Costs, operations/maintenance	19,591	158,839	19,591	158,839	n.a.	n.a.	n.a.	n.a.	330,539	2,679,950		
Tax-cost factor	5,410	43,863	5,410	43,863	n.a.	n.a.	n.a.	n.a.	0	0		
<b>Benefits - Costs (net benefit)</b>	<b>-75,842</b>	<b>-75,842</b>	<b>5,000</b>	<b>40,541</b>	<b>951,731</b>	<b>n.a.</b>	<b>n.a.</b>	<b>n.a.</b>	<b>66,108</b>	<b>535,990</b>	<b>1,444,459</b>	
Benefit-cost ratio												
Net benefit-cost ratio	0.69	0.69	4.91	4.91	n.a.	n.a.	n.a.	n.a.	1.45	1.45		
Total project cost per dwelling	-0.31	-0.31	3.91	3.91	n.a.	n.a.	n.a.	n.a.	0.45	0.45		
Project costs per dB(A) reduction per dwelling			45	366	n.a.	n.a.	n.a.	n.a.	596	4,836		
			18	146	n.a.	n.a.	n.a.	n.a.	66	537		

Figure 11.9: Output section from CBA spreadsheet (Based on Danish data for a city street with a speed limit of 50 km/h)

**Project costs - road surfaces - € for given road length and road width (present value)**

Alternative	Investment (layer)	Investment (Drainage)	Maintenance (Winter)	Maintenance (Cleaning)	Maintenance (Clean pipes)
Alternative 0	89,600	0	26,107	0	0
Alternative 1	300,079	53,600	39,161	9,081	21,729

**Noise/environmental/accident/insecurity/veh-operation costs to society - marginal costs per vehicle km - € - Alternatives 0, 1a. (From calculation sheets 0 and 1a.)**

Alternative	Noise	Local air pollution	Global air pollution	Accidents	Insecurity	Time	Vehicle operation	Sum total	Speed km/h
Alternative 0	0.020	0.023	0.010	0.107	0.018	0.167	0.123	0.468	80
Alternative 1a	0.011	0.023	0.010	0.107	0.018	0.167	0.123	0.459	80

**Noise benefits to society (reduced noise costs) - calculated € value for estimated dB(A) change per household per year - Alternatives 1b, 2, 3**

Alternative	Average noise reduction in expected life time - dB(A)	Noise benefits per dwelling per year
Alternative 1a	4.0	€ 360
Alternative 1b	5.0	€ 288
Alternative 2	9.0	€ 1,079

**CBA results - relative to Alternative 0 (that is, additional benefits and costs compared to baseline alternative)**

	Alternative 1a low-noise asphalt (benefits all effects) €/year	Alternative 1b low-noise asphalt (benefits noise) €/project	Alternative 2 barrier (plus ev. ins.) (benefits noise) €/year	Alternative 3 insulation (benefits noise) €/project
Benefits	91,049	143,835	220,547	431,504
Costs, investments	32,571	32,571	155,817	198,820
Costs, operations/maintenance	5,410	5,410	2,200	0
Tax-cost factor	7,596	7,596	31,603	39,764
<b>Benefits - Costs (net benefit)</b>	<b>368,676</b>	<b>796,656</b>	<b>250,748</b>	<b>1,564,159</b>
<b>Benefit-cost ratio</b>	<b>2.00</b>	<b>3.16</b>	<b>1.16</b>	<b>1.81</b>
Net benefit-cost ratio	1.00	2.16	0.16	0.81
Total project cost per dwelling		114	474	596
Project costs per dB(A) reduction per dwelling		28	95	66

Figure 11.10: Output section from CBA spreadsheet (Based on Danish data for an urban ring-road with a speed limit of 70 km/h)

**Project costs - road surfaces - € for given road length and road width (present value)**

Alternative	Investment (layer)	Investment (Drainage)	Maintenance (Winter)	Maintenance (Cleaning)	Maintenance (Clean pipes)
Alternative 0	134,400	0	26,107	0	0
Alternative 1	450,118	0	39,161	0	0

**Noise/environmental/accident/insecurity/veh-operation costs to society - marginal costs per vehicle km - € - Alternatives 0, 1a. (From calculation sheets 0 and 1a.)**

Alternative	Noise	Local air pollution	Global air pollution	Accidents	Insecurity	Time	Vehicle operation	Sum total	Speed km/h
Alternative 0	0.023	0.017	0.014	0.202	0.034	0.115	0.178	0.582	110
Alternative 1a	0.013	0.017	0.014	0.202	0.034	0.115	0.178	0.571	110

**Noise benefits to society (reduced noise costs) - calculated € value for estimated dB(A) change per household per year - Alternatives 1b, 2, 3**

Alternative	Average noise reduction in expected life time - dB(A)	Noise benefits per dwelling per year
Alternative 1a	4.5	€ 917
Alternative 1b	6.2	€ 1,403
Alternative 2	9.0	€ 2,476

**CBA results - relative to Alternative 0 (that is, additional benefits and costs compared to baseline alternative)**

	Alternative 1a low-noise asphalt (benefits all effects) €/year	Alternative 1b low-noise asphalt (benefits noise) €/project	Alternative 2 barrier (plus ev. ins.) (benefits noise) €/year	Alternative 3 insulation (benefits noise) €/project
Benefits	234,370	1,933,192	364,806	643,776
Costs, investments	38,940	38,940	89,543	212,930
Costs, operations/maintenance	1,610	13,054	2,200	0
Tax-cost factor	8,110	65,754	18,349	42,586
<b>Benefits - Costs (net benefit)</b>	<b>1,505,702</b>	<b>1,538,666</b>	<b>2,065,179</b>	<b>3,147,939</b>
<b>Benefit-cost ratio</b>	<b>4.82</b>	<b>4.90</b>	<b>3.31</b>	<b>2.52</b>
Net benefit-cost ratio	3.82	3.90	2.31	1.52
Total project cost per dwelling	187	1,517	423	983
Project costs per dB(A) reduction per dwelling	42	337	68	109

Figure 11.11: Output section from CBA spreadsheet (Based on Danish data for a freeway with a speed limit of 110 km/h)

However, some conclusions can be drawn based on these results; First of all, the benefit-cost ratios for low-noise asphalt (double-layer porous asphalt concrete, DPAC) are generally higher for the Danish cases than for the Norwegian example. This difference can be explained by the shorter pavement lifetimes and higher maintenance costs experienced in Norway. There are also indications of differences in the economic efficiency of the road types (and speeds). It has been assumed that the switch to porous asphalt in city streets and on ring-roads will require the installation of drainage pipes which increases the additional project costs. On lower-speed roads, there will also be more need for cleaning of the porous pavements to prevent clogging. However, the additional investment costs for porous asphalt will also depend upon the width of the road, i.e. for wide city streets (with a relatively high ADT), the additional project costs can be more than balanced with the high number of adjacent dwellings that yield high benefits even if the dB(A) reduction is lower on low-speed roads than on high-speed roads. While it was assumed that an average noise reduction of 4 dB(A) over the lifetime of the ring road would be achieved, the average reduction would be 4.5 dB(A) for the “freeway” situation and 2.5 dB(A) for the “city street” situation.

Without a formal sensitivity analysis, there are still some elements that will have a relatively clear direction on the estimates. Obviously, higher noise levels and larger noise reductions will make all alternatives more efficient. Higher numbers of dwellings adjacent to the road will only be linked directly to project costs for noise insulation (not for barriers and pavement changes), thus making low-noise asphalt and noise barriers relatively more efficient. Since the noise barriers and noise-reducing windows imply relatively higher first investment costs and lower maintenance costs when compared to low-noise pavements, a higher interest rate will make the latter relatively more efficient.

### 11.3.2 Possible ways of handling uncertainty

It should be noted that there is a degree of uncertainty in estimating applied cost and benefit values. Firstly there is a general uncertainty in attaching monetary values to changes in noise level. However, there is also uncertainty associated with the validity and reliability of attributing costs and benefits. For example, one may question to what degree the cost and benefit values reflect the full (opportunity) costs of the resources, e.g. do asphalt costs fully reflect the costs of extraction, use and disposal of waste when the road is resurfaced and do the noise benefits really represent actual willingness to pay for this “resource” (at the expense of other private and public goods)? This is related to the sustainability issue. Regarding reliability it is likely that both costs and benefits will be affected by regional market characteristics (e.g. costs of materials vary depending on location) and issues associated with differences in climate (e.g. some surfaces will deteriorate more rapidly in cold climates thereby incurring higher maintenance costs). Regarding the issue of the reduced noise benefits provided by windows compared to those for external measures (surfaces and barriers), there is an increased uncertainty in estimating these advantages. There is also a common uncertainty associated with the estimated monetary values.

Several inputs to the CBA could be given as a range of values or intervals. For point estimates an interval may be calculated from statistical data or based on market knowledge (for costs of asphalts and installations) that enables variance analysis and confidence intervals to be established

## 11.4 Summary

The cost-benefit analysis framework that has been described is sufficiently flexible to account for different noise-control measures, including a capability to account for a variable noise-reducing effect over the life cycle of the project. It can also account for cases where speed is affected directly and indirectly, and with such speed changes, the indirect effects on safety and air pollution.

Where benefits only arise from noise reduction the CBA described allows the comparison of the economic effects of low-noise surfaces compared to a conventional dense asphalt surface, noise barriers and noise-reducing windows (or façade insulation). In this case the noise benefits can be estimated from the number of affected dwellings (on both sides of the road section) and the monetary value of a dB(A) reduction.

There are some further developments of the CBA framework that should be considered. First of all, more relevant data would contribute to the modelling of the economic effects of asphalt recycling and waste handling, as well as other potential effects on water pollution and sustainability. Data from more countries would also contribute to the testing and verification of the CBA model. Last but not least, further data would facilitate the development of procedures to handle uncertainty in estimating applied cost and benefit values.

## **PART 5: THE PERFORMANCE OF LOW-NOISE SURFACES**

### ***How is performance affected by local conditions/use with other measures?***

*In selecting a low noise surface for a particular location there is a need to consider the surface as part of a road traffic system where many different factors interact. By considering interactions between these components there is a potential to optimise the noise reduction.*

*This part of the manual reviews the information from many studies which assists in understanding the nature of these interactions and, where possible, how they may be adjusted to obtain greater benefits.*

*Factors that are considered include roadside development, road layout, traffic composition and state of road maintenance which potentially impact on the performance of low noise surfaces. A review is also provided of the integration of low-noise pavements with other noise abatement measures such as the use of low noise tyres, the provision of roadside noise barriers, traffic calming measures and façade insulation.*





## 12 Factors affecting the performance of low-noise surfaces

There are a number of factors that should be considered when deciding the most appropriate low-noise pavement. It was clear from a review of the literature and insights gained from new numerical modelling work that there is considerable scope for optimising the surface design for low noise performance based on a consideration on such factors as the degree of roadside development, road alignment, traffic speed and the proportions of different vehicle types in the traffic stream. The following sections summarise the main findings reported in the SILVIA report by Haberl *et al.* [150].

### 12.1 Roadside development

When a tunnel, partial cover, opposite building facade and cutting are present, the effectiveness of a sound absorptive surface such as porous asphalt concrete when compared with a standard dense road surface may increase. This could be the result of the additional reflections on the road surface due to reflections from the walls surrounding the road which can lead to relatively high levels of sound energy being absorbed where porous asphalt concrete is used. Using numerical modelling techniques (boundary element method) it was predicted that the porous asphalt concrete surface was more effective in reducing noise levels where the conditions are more reverberant. Overall in the case of the single façade on one side of the road the improvement with porous asphalt concrete was predicted to be approximately 4 dB(A). With an opposite façade present the advantage was found to improve by just over 1 dB(A) to 5 dB(A). The addition of partial covers above the road, with the two facades present, increased the benefits substantially to close to 10 dB(A). Reflections of sound waves on the absorptive porous asphalt concrete increase as reflective surfaces are added to the road cross-section. With a nearly totally enclosed road (opposite facades plus a partial cover) a highly reverberant field is produced leading to greater reductions of overall noise levels with an absorptive surface present. The results were collaborated by other modelling work and an analysis of the situation in a totally enclosed space.

With increasing distance between opposite façades, lower façade heights and where a cover is not present it would be expected that the advantage of an absorptive surface such as porous asphalt concrete over a reflective surface such as a dense asphalt would tend toward that predicted for a single façade. Conversely inside tunnels and with narrower roads and closer façades greater improvements than those predicted should be observed. Generally, the greater the degree of enclosure the larger the amount predicted. Tunnels with reflective linings are expected to benefit to the greatest extent due to the highly reverberant field. Note that where absorptive treatments have previously been applied to facades, covers and walls the additional benefits predicted previously of laying a surface such as porous asphalt concrete will not be fully realised. The use of an absorptive surface such as porous asphalt concrete is therefore especially recommended in confined spaces and where there has been no prior application of absorptive materials.

## 12.2 Road layout

The presence of road gradients can lead to increase vehicle noise emission. For a given speed steep gradients can lead to noise level increases of 3 dB(A) or higher. However measurements have shown that a low-noise surface such as porous asphalt concrete or noise-reducing thin bituminous surfacing have similar benefits in areas where a gradient was present as on a level surface (see Figure 12.1).

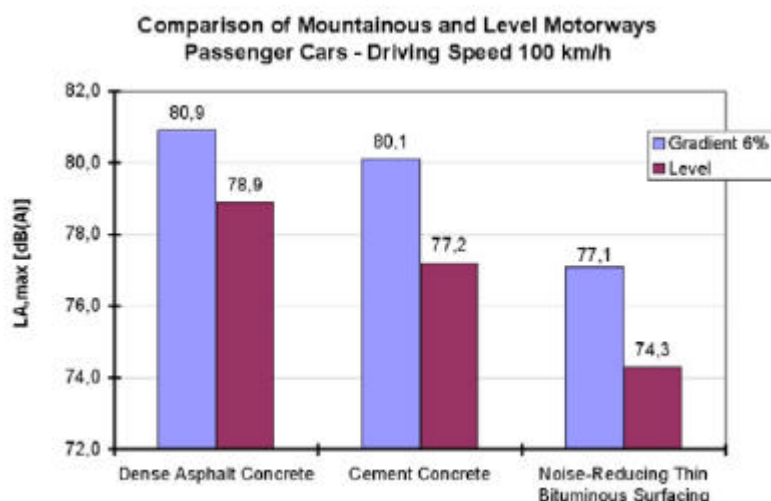

Figure 12.1: Sound pressure levels on an average mountainous motorway in Austria for passenger cars on different road surfaces [151]

Studies have shown that cornering can lead to increases in noise and annoyance due to tyre squeal, particularly where speed control measures are not introduced. Increased noise at intersections is possible due to vehicle acceleration/braking and curves (roundabouts or turning vehicles at traffic lights). A hard wearing high friction surface with a suitable fine texture to reduce tyre/road noise will assist in preventing excessive tyre slip and should be considered for these situations. Skidding accidents can also be prevented so this could be an example of a 'win-win' solution. Reduced speed limits on approaches to intersections and curves and the use of methods to promote a smoother flow of traffic through intersections can also help to reduce noise emissions from both the tyres and other vehicle sources.

## 12.3 High-speed roads

On the highest speed roads the correct choice of surfacing is particularly important because the increase in noise level on rougher surfaces can be significantly greater than for smoother surfaces. Consequently, relying on measurements of tyre/surface noise at lower speeds can be misleading. Alternatives to surfaces with known relatively high rates of increase in noise with speed, such as brushed or grooved concrete and hot rolled asphalt, should be considered for such situations. As an example a surface such as SMA with a 14 mm chipping size would be preferable to both brushed concrete and hot rolled

asphalt and is a practical durable surface. Of course the wet grip adhesion of any surface needs to be adequate to avoid problems with skidding and high speed aquaplaning under wet conditions. Based on measured differences in speed coefficients a difference in the maximum coast-by noise of 3 dB(A) at 80 km/h would be expected to widen to 4.5 dB(A) at the higher speed of 135 km/h.

It should be noted that the different rates of noise increase on rougher road surfaces is being considered in the specification of the test surface used in vehicle noise type approval. The ISO test surface specification stated in ISO 10844 [152], which is a relatively smooth surface currently used in type approval testing, is being revised by ISO/TC/SC1/WG42TT. It is anticipated that an alternative rougher surface will be proposed.

## 12.4 Traffic composition

The proportion of trucks to light vehicles in the traffic stream can play an important part in determining the type of road surface to use for optimum acoustic performance. For example, a road surface optimised to produce low levels of noise from passing trucks will be different from a pavement selected for yielding low noise from passenger cars. Even within a road it is possible to conceive of different surfaces for different traffic lanes. For example on motorways the inside lane typically carries a higher percentage of relatively slow moving heavy vehicles while the outside lane may carry no heavy vehicles and speeds will often be much greater. In this situation a uniform surface treatment across all lanes is unlikely to be optimum in terms of noise suppression.

## 12.5 Repairs and joints

Following local road repairs it is important to ensure that the repaired surface does not have any significant different texture characteristics or badly reinstated joints where it meets the existing surface. Any differences in noise from vehicles passing over the repaired surface can be particularly annoying to residents living close by. The length of the spacing between repairs can be critical and there is evidence that a regularly oscillating noise level produced by a series of patches is particularly annoying. Such changes in noise are particularly noticeable if the traffic flow is low and where individual pass-bys can be identified. This situation is most likely to occur in the evening or at night when residents are likely to be relaxing or sleeping which will tend to increase the level of disturbance. Note that a patch with a lower noise characteristic to the existing surfacing may also be a problem as this will also create changes in noise level as vehicles pass by.

Changes of road surface type may also introduce road surface profile irregularities. The most usual are a step up or step down. This can cause impulsive body rattle noise as vehicles traverse the irregularity. Measurements have shown that peak levels of noise can be over 10 dB(A) above the original level resulting, in some cases, to significant disturbance to those living in the vicinity. In many cases heavy goods vehicles produce the loudest noises in these circumstances due to a variety of causes such as a poorly secured loads, loose body components e.g. tail gates, lifting equipment and chains and suspension noises. The remedy is to take special care to avoid irregularities at the

interface. Where differences of surface height are unavoidable a sufficiently long ramp is required to smooth the profile or the irregularity should be sited at a sufficient distance from residential properties.

Pass-by noise levels have also been shown to increase significantly in the presence of bridge joints, by 10 to 15 dB(A) depending upon the quality of the joint. In the case of a noisy joint, the noise peak will be larger on a quiet road surface than on a noisy one, thus probably making it more annoying. Joints containing elastomers have been developed recently, that do not cause such noise peaks when vehicles are passing over, even with a low-noise road surface. Note that if long term  $L_{Aeq}$  measurements are performed in the vicinity of a joint, the effect of noise peaks on measured values may be small and the true impact is not reflected in recorded values. This is because of a number of factors including the mix of vehicles, background noise and the road surface on either side of the joint. In addition even if there is an increase in  $L_{Aeq}$  the annoyance caused is unlikely to be fully reflected in the change due to the repetitive and impulsive nature of the noise that is created by the joint. Unfortunately there are no standardised measurement methods for assessing the true impact of bridge joints. The availability of such a standard would probably assist the adoption of innovative joint solutions.

## 12.6 Weather effects

It has been demonstrated that a thin film of water on the road surface can increase the A-weighted sound power by several decibels. However, a damp road surface has little effect on pass-by noise levels. For light vehicles the increase is highest at low speeds but for heavy trucks the opposite appears to be the case. Corrections have been devised for light vehicles though for heavy trucks the data is considered unreliable and therefore no corrections are given. Where the surface is porous, rain water may drain freely such that a continuous surface film cannot be established however due to the blocking of the pores by water there is a loss of performance which may last several hours after the rain has ceased. Traffic noise levels have been observed to increase by 3-4 dB(A) following rainfall (Section 11.15, [10]).

For non-porous surfaces corrections are given for passenger cars in the HARMONOISE model above 1 kHz [153]. For example at 1250 Hz the correction at a speed of 50 km/h is an increase of 0.9 dB(A). In practice speed decreases due to reduced visibility such that the increase can be off-set. For example on hot rolled asphalt there was no significant increase in traffic noise following rainfall.

Clearly snow and ice can also block the pores of porous surfaces although the application of de-icing salt will assist in maintaining performance.

Temperatures effects are also measurable and different corrections have been given to the rolling noise component for a wide range of surfaces [153]. Insufficient data is available to produce sufficiently accurate predictions at different frequencies. For example on SMA at 30°C the correction is -0.6 dB(A) while at 10°C the correction is +0.6 dB(A). On DAC the corresponding corrections are higher at -1 and +1 dB(A) respectively.

## 12.7 Studded tyres

The use of studded tyres will increase rolling noise significantly. This is due to the impact of the metal studs with the road surface and the resulting vibrations set up in the tyre. At speeds between approximately 70-90 km/h the effect of new studs produces a noise increase of approximately 2-6 dB(A) in the band 500-5000 Hz while above these frequencies the increase is approximately 5-15 dB (Section 10.10, [10]). When the studs wear the noise increase is approximately 3-7 dB above 5 kHz. In the HARMONOISE model corrections are given at each frequency in the third-octave bands from 125 Hz to 10 kHz. At 1 kHz at 50 km/h the correction is 3.8 dB(A) and this increase is applied to any road surface.



## 13 The integration of low-noise surfaces with other mitigation measures

There are a large number of parameters that effect overall traffic noise. Figure 13.1 gives a summary of some of factors that effect vehicle/tyre/road noise. In addition to the vehicle and tyre parameters, the local conditions and the road surface also play an important role. In fact, the properties of the road surface can lead to a completely different relationship between certain tyre parameters and traffic noise.

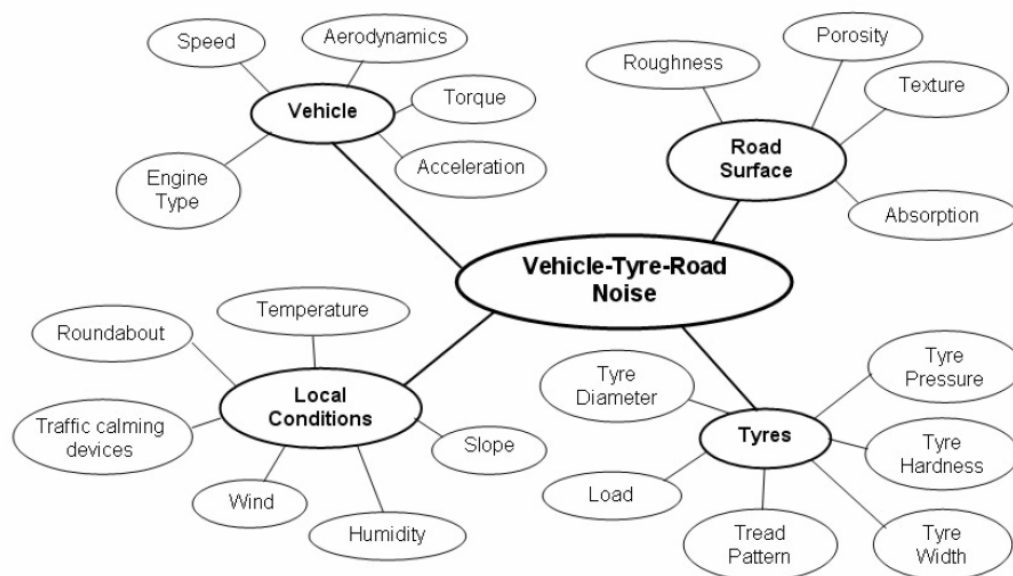

Figure 13.1: Influences of tyre, vehicle and road surface properties on the overall traffic noise

### 13.1 Vehicle factors

It is important to look at differences in the vehicle parameters and how they influence the noise levels. One potential difference is the tyres fitted to the vehicle. Tyre parameters can significantly influence the levels of traffic noise. In an Austrian study the tyre profile pattern, the shoulder profile depth and the tyre thread mixture as well as the structure of the longitudinal grooves were systematically changed in three dimensions using 37 passenger car tyres [154]. It was found that controlling for tyre width the important parameters affecting pass-by noise levels at 80 km/h on the ISO surface were tread block pattern and tyre construction. Each of these two factors could account for approximately 2 dB(A) in the variation of pass-by noise on this test surface. On other surfaces even greater variations can be expected.

More detailed information on the influence of vehicle and tyre parameters on traffic noise can be found in the SILVIA Project Report by Pucher *et al.* [155].

Figure 13.2 indicates the potential noise reduction that could be achieved by optimising vehicle propulsion, tyres and the road surface [63].

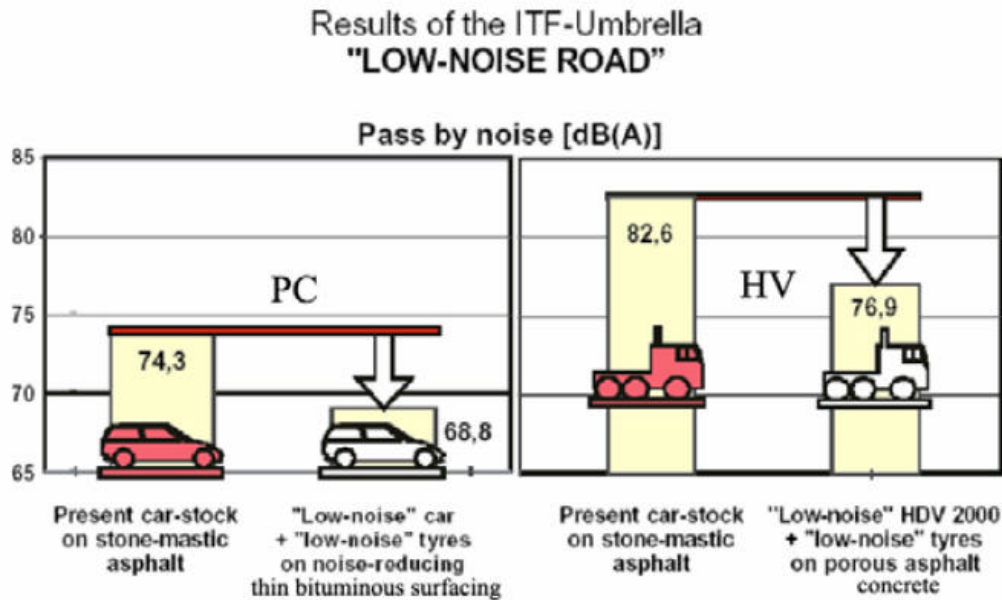

Figure 13.2: Possible improvements for passenger cars and heavy vehicles in the accelerated pass-by situation

It can be seen that potential reductions taking this systems approach is of the order of 6 dB(A) for both light and heavy vehicles when the reference road surface is a stone mastic asphalt.

## 13.2 Noise barriers and earthworks

Combining noise barriers and/or earthworks with noise reducing pavements may lead to an optimal solution to reducing traffic noise however the benefits of each measure are often not completely additive when used in combination.

Most of the knowledge on the combined effects of barriers and noise reducing surfaces is based on theoretical predictions. Simple models often overestimate the efficiency compared to measured performances. However detailed investigations using more sophisticated models, e.g. numerical methods such as the boundary element method (BEM), are likely to achieve more accurate predictions. Measurement data for the combined use of these measures is rare, probably because it is very difficult to evaluate the relative contribution of the road surface and the noise barrier. A survey of the literature has identified one relevant study where roadside measurements have been made behind a noise barrier with an existing dense asphalt surface and then later with a porous asphalt surface present. Without a barrier present this showed that the advantage of porous



asphalt over the benefit of dense asphalt was about 3 dB(A) whereas it was only 1.5 dB(A) in the presence of the noise barrier i.e. a loss of 1.5 dB(A). In a separate study using the BEM the effects of a 2 m high barrier were modelled with and without porous asphalt. The loss of advantage of this porous surface over a reference non-porous surface (hot rolled asphalt) was estimated to be of a similar order i.e. in the range 0 to 1.4 dB(A) depending on the receiver positions used.

It was concluded that due to changes in the geometry of sound wave propagation, diffraction and absorption, the overall efficiency of the combination is less than would be calculated by summing the reductions provided by the individual measures. When using noise reducing surfaces in combination with barriers, close attention should be paid to the spectral efficiency of the different measures and the height of the barrier and its position relative to the road. The situation is further complicated when barriers are present on both sides of the road. In all these cases the use of a suitable prediction model will assist in predicting the benefits and optimising the design of the total system.

More detailed information on the combined effects of low-noise road surfaces and noise barriers can be found in the SILVIA Project Report by Anfosso-Lédée *et al.* [156] and Haberl *et al.* [150].

### 13.3 Façade insulation

The combination of a low noise road surface that reduces noise at the source, and a façade with enhanced sound insulation that reduces the sound transmitted inside the building, is an effective solution for road traffic noise reduction inside dwellings. But as found previously for combinations with noise barriers, the resulting benefit may be less than the addition of respective benefits. The reason is the frequency dependence of sound transmission and the frequencies at which significant differences occur in the spectra of tyre/road surface noise for the low noise surface and the standard surface.

In order to accurately gauge noise impact on the community it is important to be able to predict the likely added benefit inside a building that the use of a low noise pavement can achieve taking into account the façade insulation.

As no published results of indoor effect of low noise road surfaces have been found in the literature search, a basic simulation was performed in order to give an idea of the combination of low noise road surface and façade insulation using typical traffic noise spectrum from porous asphalt and dense asphalt and the average attenuation through windows. This had a sound insulation value of approximately 35 dB at 1 kHz which lies near the middle of the range of values that have been measured for all types of windows in dwellings. The basic simulation consists in subtracting the sound insulation spectrum from the road traffic noise spectra, to obtain the indoor sound pressure spectrum for both porous asphalt and dense asphalt.

The calculated A-weighted advantage of double layer porous asphalt over dense asphalt, gave an outdoor advantage of 4.5 dB(A). However indoors the calculated advantage was 3.1 dB(A). Thus the physical benefit of the porous pavement is lower indoors than outdoors by 1.4 dB(A). This is comparable with the loss of advantage found when combining a single 2 m high noise barrier with porous asphalt.

More detailed information on the combined effects of low-noise road surfaces and façade insulation can be found in the SILVIA Project Reports by Anfosso-Lédée *et al.* [156] and Haberl *et al.* [150].

### 13.4 Traffic management measures

Traffic management measures such as environmentally adapted “through” roads, 30 km/h zones, road humps, roundabouts, restrictions on traffic in special periods, speed control etc. are used on many urban roads in Europe. These measures are usually applied to improve traffic safety, typically by reducing the speed, and to reduce the environmental impacts in residential areas that are caused by the traffic in order to make the areas more pleasant for both residents and pedestrians. The reduction in speed leads to a reduction in average speed and as a consequence average noise levels ( $L_{Aeq}$ ) can fall significantly.

The combined use of traffic management measures and noise reducing pavements can offer an optimised solution for noise abatement. Both contribute to reducing noise emitted at the source, while the latter may also act on the sound propagation if porous. The two measures may also affect the frequency distribution of road traffic noise in different ways, and this can have an influence on the total noise reduction. However, in the absence of sufficient information it is recommended that the effects of the two types of noise reduction are added on a dB basis.

Combining the use of noise reducing pavements and traffic management measures, the overall potential for noise reduction on urban roads may be of the order of 3 to 8 dB(A). On highways with high speeds the potential for noise reduction may be up to 10 dB(A) or greater.

Generally noise reducing pavements are more effective in reducing noise from light vehicles than noise from heavy vehicles. This means that if the effect of a traffic management measure such as an environmentally adapted street or a 30 km/h zone is to reduce the percentage of heavy vehicles, then the beneficial effects of the noise reducing pavement will be increased.

The potential effects of different types of traffic management measure can be broadly summarised, based on reviews of the different measures reported by Haberl *et al.* [150], as shown in Table 13.1. It should be noted that the true effects of the different measures depend very much upon the precise design of the measures, how they are implemented and the reaction to them by vehicle drivers. Clearly, some measures will be inappropriate under some road conditions. It can generally be concluded that average noise levels can be reduced by up to 4 dB(A), although higher reductions may be result with some special measures. However, with flat topped humps and some speed cushions average levels may increase.

*Table 13.1: Summary of different traffic management measures and an indication of their effect on average traffic noise*

<b>Traffic management measure</b>	<b>Potential change in <math>L_{Aeq}</math></b>	<b>Remarks</b>
Traffic calming/Environmentally adapted through-roads	0 to -4 dB(A)	Achieved using a combination of speed reduction measures on road sections
30 km/h zone	0 to -2 dB(A)	For roads where only speed signs were used to enforce slow driving
Roundabouts	0 to -4 dB(A)	Complaints about noise from body rattle, braking and acceleration have been observed for most physical road deflections especially vertical
Circle-top road humps	0 to -2 dB(A)	
Flat-top road humps	0 to +6 dB(A)	
Narrow speed cushions	0 to +1 dB(A)	
Night-time restrictions on heavy vehicles	0 to -7 dB(A) at night-time	Increased noise reported during the morning period
Speed limits combine with signs warning of noise disturbance	-1 to -4 dB(A)	
Rumble strips (thermoplastic)	0 to +4 dB(A)	Suggestion of +5 dB(A) for impulsive noise
Rumble areas (paving stones)	0 to +3 dB(A)	Suggestion of +5 dB(A) for impulsive noise
Rumble wave devices	0 dB(A)	These are designed only to increase noise within the vehicle

In addition to the potential noise reductions identified by the different studies, the following general conclusions can be drawn with regard to traffic management measures:

- Reductions in vehicle speed reduce vehicle noise and generally have a positive effect on traffic safety. However, in the case of heavy vehicles, noise levels are sometimes increased due to an increase in gear changing and body rattle noise;
- The use of speed limit signs is often insufficient for achieving a reduction in vehicle speeds and hence noise. The redesign and realignment of the road may also be necessary so that the physical layout is appropriate for the intended speed. Road markings can be useful in reinforcing information conveyed by traffic signs;
- It is important that any measures used maintain as smooth a driving pattern as is possible when passing through/over the measure. Uneven driving patterns can be minimised by having a sufficient separation between physical measures;
- It is important that the speed reduction measures do not result in driving patterns where the vehicles are brought to a complete stop, since this would generate increase noise from higher vehicle engine speeds due to acceleration in low gears;

- Speed reduction measures which displace the vehicle to the left or right of the main running lane are often effective in reducing noise, particularly in the case of heavy vehicles (providing there is no increase in body rattle);
- Speed reduction measures that change the height of all or part of the road, e.g. road humps, can sometimes have a negative impact on noise levels, especially in the case of heavy vehicles where body rattle noise can result in large peaks in noise levels as the vehicles cross the measures. The use of such measures may also generate perceptible levels of vibration in nearby buildings, although this is dependent upon the ground condition and the distance from the road to the nearest building foundations. In particular serious levels of annoyance have been reported where residential properties are close to road humps that are built on soft ground such as peat soils and alluvium deposits;
- The use of uneven surfaces, rumble areas and strips, block paving and cobbles can increase noise levels while rumblewave devices based on an appropriate sinusoidal road profile have been shown to have an insignificant effect on A-weighted noise levels.

Although some social surveys have been conducted with regard to traffic management, there is a need for greater, more detailed knowledge relating to the *perception* of noise from traffic management measures. In some of the surveys that were reviewed by Haberl *et al.* [150], the degree of annoyance was decreased following introduction of the measures whilst in others it was observed to increase.

Clearly there is considerable scope for combining traffic managements measures with low noise pavements and further studies are required where different combinations are examined for effectiveness. Low noise pavements that are particularly effective at low speeds should be selected in traffic calmed areas where more severe speed reductions are achieved e.g. roads where road humps have been installed at frequent intervals.

More detailed information on the effects of traffic management measures can be found in the SILVIA Project Reports by Bendtsen *et al.* [198] and Haberl *et al.* [150].

## **PART 6: ADVICE ON LOW-NOISE SURFACES**

### ***How to use and assess the surfaces?***

*This Part of the manual provides advice to road authorities on selecting low-noise surfaces and considers the issues of conformity of production and routine monitoring.*

*In addition to a consideration of the required noise reduction the issues of construction and maintenance (including cleaning methods), structural durability, winter maintenance, recycling and costs are addressed.*

*The conformity of production method is reviewed. It is essential for ensuring that adequate quality control has been exercised in laying a new road section. An important feature of the method is that the surface is assessed as a series of individual sections each of which is checked to determine whether it passes or fails the COP criteria.*

*In addition to COP procedures the issue of routine and periodic monitoring of surfaces is addressed. Generally the time interval between tests will be shorter for porous surfaces than dense surfaces because of the potential for clogging of the pores with road detritus which is known to lead to a reduction in acoustic performance.*



## 14 Advice on the selection of low-noise surfaces

The following subsections provide advice on the different factors that must be taken into account when selecting low-noise surfaces for use on highways. Some of the issues that are relevant have previously been discussed in detail in Chapters 10, 11, 12 and 13 and for these issues only a brief summary is provided here for completeness.

When deciding on an appropriate surface there is often a balance to be struck between reduced noise and the potential rise in some accident risk factors. The impact on sustainability is a further factor that may need to be taken into account. As discussed in Chapter 10 the main differences in safety and sustainability can be seen when comparing the performance of porous and dense asphalt road surfaces.

Porous asphalt is widely used in the EU and is favoured because of its ability to reduce traffic noise and reduce splash and spray in wet weather due to its water drainage properties. Visibility is improved in wet weather and the risk of aquaplaning reduced. Under low light conditions the visibility of road markings is improved since light reflected from water films is greatly reduced. However, it has been difficult to quantify the effects on accident rates. It is likely that despite the increase in visibility and the reduction in the risk of aquaplaning, speeds may not decrease as much as on non-porous surfaces under wet weather conditions. In addition in wintertime there is the risk that the road surface temperature stays below freezing longer due to the lower thermal conductivity of a porous asphalt surface compared to a dense asphalt surface. The consequences are that a porous asphalt surface is more prone to be covered with ice in winter than a dense asphalt surface.

The impact on sustainability of changing to a low noise surface such as porous asphalt also needs consideration. Road pollutants from highways include heavy metals and hydrocarbons. The run-off of these pollutants from roads to rivers and streams can critically depend on the porosity of the road surface. It has been argued that porous asphalt has a filtering effect on surface water and reduces the rate of run-off. This slower discharge can reduce peak flows and reduce flooding. The major potential disadvantage of porous asphalt is the need to apply a higher rate of de-icing salts in winter. Estimates for the increased quantity vary from 30 to 45%. As a consequence corrosion rates are higher and more heavy metals are observed in the run-off water from porous asphalt. This negative impact will tend to be greater in northern countries and mountainous areas of central Europe where winter conditions are more severe. Clogging of porous surfaces with detritus can affect both the acoustic properties and water drainage and, particularly where these surfaces are located on roads where the traffic is slow moving, additional cleaning of the surface with water jets may then be needed. This may therefore involve extra maintenance costs when compared with non porous surfaces. There is also the potential problem of the accumulation of toxic materials in the pores which could potentially affect recycling although there is evidence that this is not a serious problem and can be overcome.

Rolling resistance is also affected by the choice of road surface. It has been found that the megatexture (50 mm to 0.5 m) is important for rolling resistance and hence fuel consumption. In this respect it is likely that a fine graded low noise surface will have lower rolling resistance than rougher surfaces.

As described in Chapter 12 the choice of pavements will also depend on road layout, traffic speeds and compositions as well as the nature of any road side development. For example, porous asphalt, because of sound absorptive qualities, is predicted to be particularly effective in reducing noise in confined road spaces where buildings on both sides of the road form a deep narrow "canyon". The effect is further enhanced if there is a cover, or partial cover, over the road. Porous asphalt is considered to be particularly effective in reducing noise in tunnels to enhance the acoustic environment of road users and at tunnel portals to reduce the noise impact on local communities. However, the use of porous asphalt in tunnels is limited by problems associated with accidents involving hazardous goods and the difficulties in cleaning the surface compared with a dense asphalt concrete.

The performance of low noise surfaces will also depend on the speed of traffic and numbers of heavy vehicles. For example the increase in noise with speed can be higher on rougher surfaces than smoother surfaces. Also a surface optimised to reduce noise from light vehicles may not be optimal for heavier vehicles due to the significant differences between vehicle classes in tyre size, construction and tread block patterns. Where the percentage of heavy vehicles is high, therefore, it may be necessary to consider a surface which is appropriate for reducing the noise from such vehicles.

Noise levels can increase on curves and near intersections where acceleration rates are relatively high. In these situations improvements to the surface skid resistance can reduce tyre noise and improve safety. There are fine graded, high friction products on the market that can be successfully applied as a surface treatment at these locations.

The sections below provide further details of the important considerations including cost benefit analysis when selecting appropriate surfaces for a given application.

### **14.1 Required noise reduction (maximum or specific in combination with other noise abatement measures)**

When selecting and specifying a low-noise surface, or for that matter any other noise mitigation measure, it is important to consider precisely how the target noise reductions are defined and whether the surfaces are to be used as a sole measure or in combination with other measures. It is important to remember that in many cases the benefits of individual measures cannot be combined when used in conjunction with another mitigation measure, e.g. the benefits of using low-noise surfaces are generally reduced when used in combination with noise barriers due to the changes in the geometry of the sound wave propagation. Chapter 13 gives more details on the effects of combining different noise reduction treatments.

The location of the area where the noise reduction is required also needs to be considered. An industrial area may not need the same degree of noise control as a residential area or area of where noise impacts are likely to be particularly intrusive – e.g. designated tranquil areas



## 14.2 Acoustic durability - reduction in noise with surface age

It is important to be aware that unlike some other mitigation measures, the acoustic performance of low-noise surfaces will tend to degrade over time as a result of general wear due to trafficking and weathering causing deterioration in the physical quality of materials and changes in the texture of the surface e.g. surface fretting. In the case of porous surfaces, clogging of the voids in the surface by dirt, dust or other clogging agents such as detritus from the actual pavement, tyres and from oil products can also reduce the acoustic performance over time.

Remedial action such as programmed maintenance and, where relevant, cleaning will help to extend the acoustic lifetime of the pavements to a limited degree, returning the performance somewhat towards that achieved when new, but cannot be carried out indefinitely.

Figure 14.1 to Figure 14.4 show examples of how the acoustic performance of different surfaces varies over the time, based on data from the surfaces reported in Chapter 4 of this manual.

In Figure 14.1 the results for porous asphalt and double layer porous asphalt are compared. It can be seen that, for each of the surfaces examined, there is a gradual increase in noise level over the five year period of measurements. The greatest increases are seen for the double layer porous asphalt surfaces.

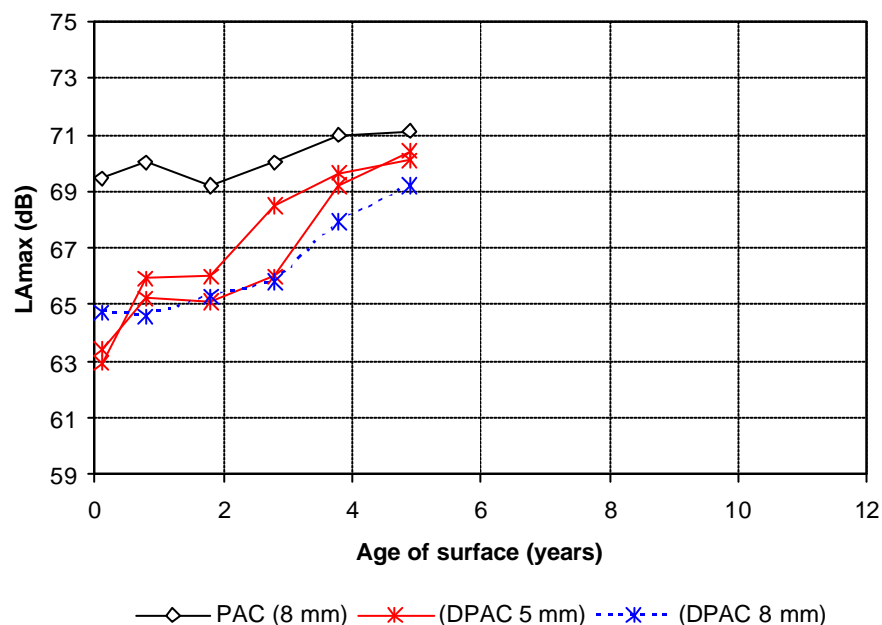

Figure 14.1: Acoustic performance over time for light vehicles at a 50 km/h reference speed

In Figure 14.2, the results from a range of low noise surfaces can be compared with some examples of conventional surfaces i.e. Hot Rolled Asphalt (HRA) and brushed cement concrete (BCC). Again it can be seen that for most of the surfaces a gradual rise in noise

over time is indicated. Interestingly increases in noise over time are also found for one of the HRA and BCC surfaces indicating that acoustic performance of some conventional surfaces may also be reduced over time.

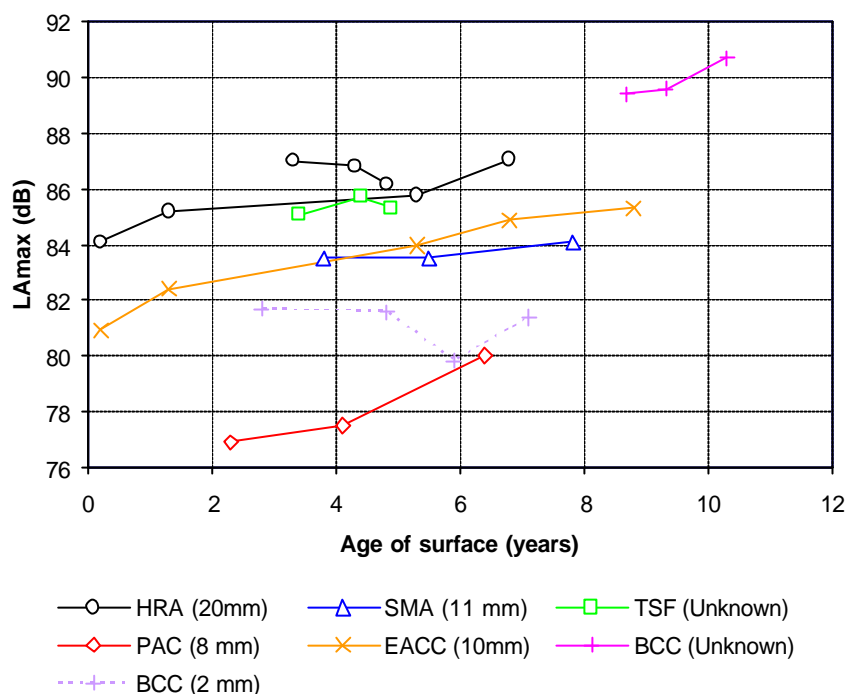

Figure 14.2: Acoustic performance over time for light vehicles at a 110 km/h reference speed

The results for medium heavy and heavy vehicles are shown in Figure 14.3 and Figure 14.4, for speeds of 85 km/h respectively. In both cases there is also a gradual rise in noise level over time indicated for some surface types, although as might be expected, the trends are not as clearly apparent as is the case for light vehicles. This is partly attributable to the reduced dependence of heavy vehicle noise on surface type and to the relatively short time periods where noise data was available for some of the surfaces.

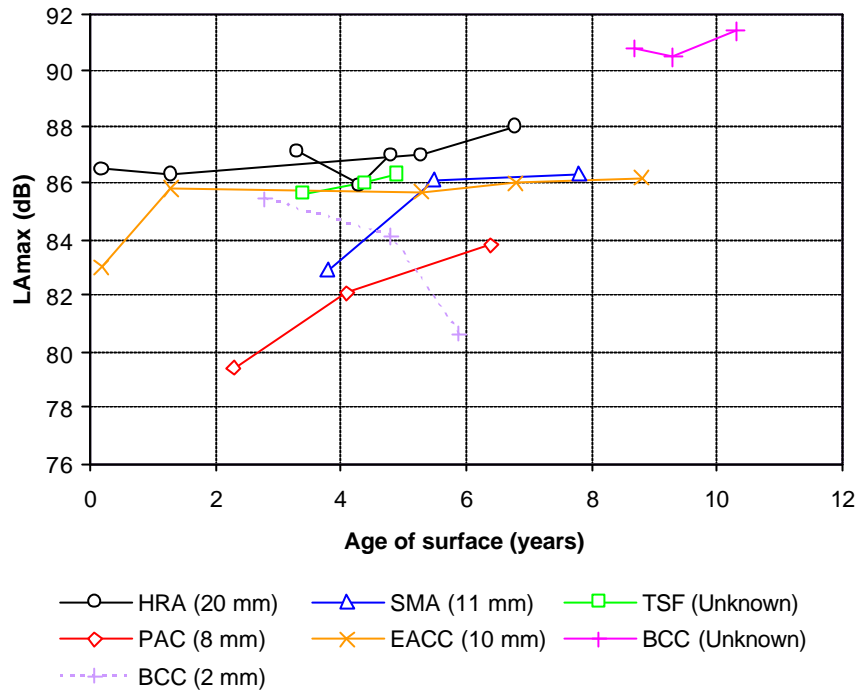

Figure 14.3: Acoustic performance over time for medium heavy vehicles at an 85 km/h reference speed

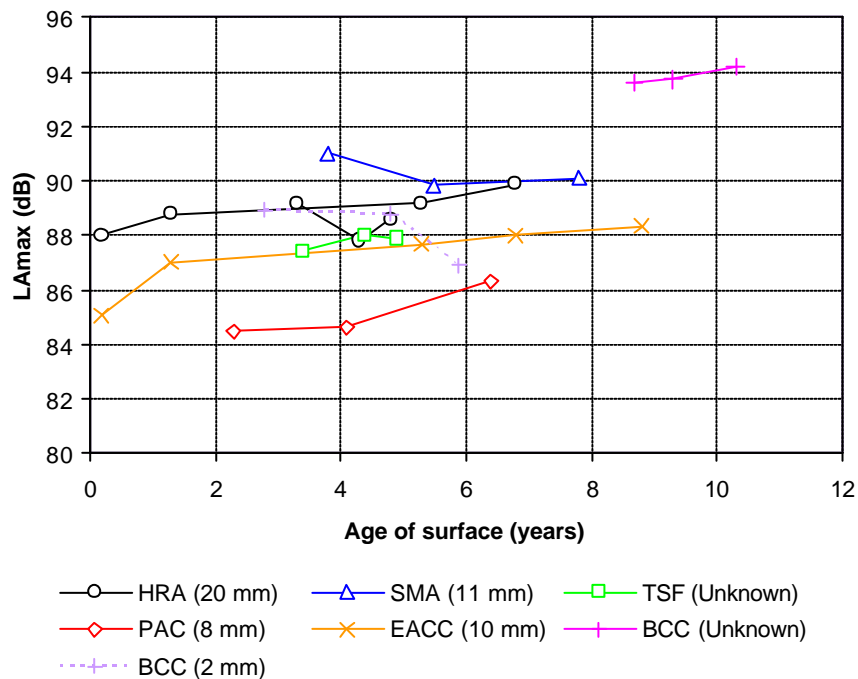

Figure 14.4: Acoustic performance over time for heavy vehicles at an 85 km/h reference speed

### 14.3 Cost benefit analysis

The cost-benefit analysis Excel spreadsheet on the CD-ROM attached to this manual can be used to examine options for noise control including a comparison between different low noise surfaces and alternatives such as noise barriers. The spreadsheet is flexible enough to allow the changes in acoustic performance of a road surface over time so that whole lifetime benefits can be accounted for accurately. If speed changes following the introduction of a particular surface are known then the analysis provides possible effects on safety and air pollution.

Where the benefits can only be quantified in terms of noise reductions the spreadsheet allows the comparison of the economic effects of low-noise surfaces compared to a conventional dense asphalt surface, noise barriers and noise-reducing windows (or façade insulation). The noise benefits can be estimated from the number of affected dwellings (on both sides of the road section) and the monetary value of a dB(A) reduction. The latter will vary across Europe and Member States will need to provide values based on their locally available data.

The CBA analysis could be improved if relevant data were made available regarding the economic effects of asphalt recycling and waste handling, as well as other potential effects on water pollution and sustainability. Additional data from a wide range of countries would also contribute to the testing and verification of the CBA model and the development of procedures for calculating uncertainty in estimating applied cost and benefit values.

## 15 Advice on the assessment of surfaces

The classification system described in Section 9, and more fully in Appendix C, of this Guidance Manual sets out details of methods and procedures that can be used for the acoustic labelling of low-noise surfaces. These labels can be used by surface manufacturers to promote their surfaces and can be used by highway authorities and planners as part of the design process. However once a surface has been selected for use and routinely laid on the highway, it is important to know that the surface laid meets the specifications required by the contract. Furthermore, the label information and any resulting Conformity of Production (COP) measurements provide a benchmark against which the performance of a surface can be monitored over its lifetime.

This section of the manual deals with the issues of COP and routine monitoring.

### 15.1 Conformity-of-production (COP) assessment

Conformity of Production (COP) is intended to check to what extent the properties of a given surface that has been routinely laid (of which the type is defined) correspond with the known properties that can be expected from that specific type of surface.

The procedures for COP assessment and the corresponding tolerances for acceptance under the procedure are given in Appendix C. It is important to note that although the results make a statement regarding the product being assessed, they only indicate whether a product has satisfied the acoustic performance defined by the label for that type of surface. The tolerances defined in the Appendix take into account material variations, the precision and repeatability of the test methods and potential operator error and are based on the judgement of experts from the consortium partners involved in the writing of this Guidance Manual.

It will be noted that the COP assessment is based on measurement methods other than the SPB method. This is because the SPB method, whilst appropriate for classification and labelling surface types where the conditions of the measurement standard can be achieved, cannot be used routinely in-situ where non standard measurement conditions may exist. It is also relatively site specific and therefore an expensive approach to use for COP applications where several measurements along a length of road may be needed to establish conformity.

One of the most important aspects of the COP assessment procedures is that any surface is assessed as a series of individual 100 m sections, each of which is deemed to either satisfy or fail the requirements of the COP assessment. The consequences of failure fall outside the scope of this Guidance Manual, i.e. there is no comment on the degree of failure or on how failure should be addressed. It is the responsibility of the road authority and the surface contractor to negotiate how these consequences should be handled, including arrangements for any appeals procedure. The definition of an appeal procedure is also outside the scope of this Guidance Manual.

## 15.2 Routine and/or periodic monitoring of surfaces

Periodic monitoring of a road surface will establish whether changes in the acoustic performance of the surface have occurred and indicate whether maintenance or replacement may be necessary. The time interval between measurements is variable and will depend on the anticipated acoustic durability of the road surface in question. For example, it may be appropriate to test once every five years for dense surfaces and once every 2 years for porous surfaces.

The precise time interval will be at the discretion of the responsible road authority and may be based on either the Authority's own prior experience and/or advice/guidance from the relevant surface contractor or recognised experts.

Although the initial labelling/COP assessment of a surface is not necessary to perform routine monitoring, it does provide a benchmark against which the performance of the surface can be assessed. As such, the assessment methods recommended for monitoring conform to those used elsewhere in the labelling procedure.

The test method recommended for monitoring is the CPX method. However, it will be the decision of the road authority as to the precise level of testing, i.e. whether to perform the test with only passenger car tyres or with two tyres, one representing passenger car tyres and one representing truck tyres. Furthermore, measurements of surface texture and (if relevant) absorption are also recommended to provide supplementary information.

If CPX measuring equipment is not available the test may also be executed using the texture method and if applicable absorption and mechanical impedance measurements. If only static measurements are used, then it should be noted that the "resolution" of the monitoring measurements will provide a poorer picture of the overall performance of the surface.

## References

- [1] **European Environment Agency (2003).** *Europe's environment: The third assessment.* EEA Environmental Assessment Report No. 10. EEA, Copenhagen, Denmark.
- [2] **Danish Environmental Protection Agency (2003).** *Forslag til strategi for begrænsning af vejtrafikstøj (Proposal for a strategy for the reduction of road traffic noise (in Danish)).* The Road Noise Group: Ministry of the Environment, Ministry of Finance, Ministry of Transport, Ministry of the Interior and Health, Ministry of Justice and Ministry of Economy and Enterprise. November 2003. [www.mst.dk](http://www.mst.dk).
- [3] **Commission of the European Communities (1996).** *Future noise policy.* European Commission Green Paper COM(96) 540, final, Brussels.
- [4] **Danish Environmental Protection Agency (2003).** *Hvad koster støj? – værdisætning af vejstøj ved brug af husprismetoden (What are the costs of noise? – Evaluation by the use of the house-pricing method (in Danish)).* Environmental project no. 795, 2003. Environmental Protection Agency. [www.mst.dk](http://www.mst.dk).
- [5] **Watts G, Nelson P, Treleven C and Balsom M (2005).** *An examination of vehicle noise test procedures.* TRL Published Project Report PPR044. TRL Limited, Wokingham, UK.
- [6] **Please A, O'Connell B J and Buglass B F (1970).** *A bituminous surface-texture experiment, High Wycombe by-pass (M40), 1967.* RRL Report LR 307. Road Research Laboratory. Ministry of Transport. Crowthorne, Berkshire. UK.
- [7] **Plomp R and Bouman M A (1959).** *Relation between hearing threshold and duration for tone pulses.* Journal of the Acoustical Society of America **31**, 749-758.
- [8] **Anderson J S and Bratos-Anderson M (1993).** *Noise: Its measurement, analysis, rating and control.* Avebury Technical, Aldershot, UK.
- [9] **Commission of the European Communities (2002).** *Directive 2002/49/EC of the European Parliament and of the Council relating to the assessment and management of environmental noise.* Official Journal of the European Commission, L189/12.
- [10] **Sandberg U and Ejsmont J A (2002).** *Tyre/road noise reference book.* Informex, Sweden.
- [11] **Plotkin K J, Montroll M L and Fuller W R (1980).** *The generation of tyre noise by air pumping and carcass vibration.* Proceedings of Inter-Noise 80, Miami, Florida, USA, 273-276.
- [12] **Bergmann M (1980).** *Noise generation by tyre vibration.* Proceedings of Inter-Noise 80, Miami, Florida, USA, 239-244.

- [13] **Hayden R E (1971)**. *Roadside noise from the interaction of a rolling tyre with the road surface*. Proceedings of the Purdue Noise Control Conference, Purdue University, USA.
- [14] **Nilsson N A (1979)**. *Air resonant and vibrational radiations - possible mechanisms for noise from cross-bar tyres*. Proceedings of the International Tyre Noise Conference, Stockholm, Sweden.
- [15] **Sandberg U and Descornet G (1980)**. *Road surface influence on tyre/road noise - Parts I and II*. Proceedings of Inter-Noise 80, Miami, Florida, USA, 259-266; 267-272.
- [16] **Hamet J-F, Deffayet C and Pallas M-A (1990)**. *Air pumping phenomena in road cavities*. Proceedings of INTROOC 90 (International Tyre/Road Noise Conference 1990). Gothenburg, Sweden, 19-29.
- [17] **Sandberg U (1987)**. *Noise and the road - is there a conflict between requirements for safety and noise?* Extract from the Revue Ingenieurs de l'Automobile, January, Paris, France.
- [18] **Cena B and Travaglio G (1995)**. *Noise and fuel economy: Two challenging objectives for tyre manufactures*. Proceedings of Tyretech '95, Torino, Italy.
- [19] **Fabre B (1979)**. *Some results concerning current research on tyre in France*. International Noise Conference, Stockholm, 270-280.
- [20] **Nelson P M and Underwood M C P (1984)**. *Lorry tyre noise*. Proceedings of the Conference on Vehicle Noise and Vibration. Institute of Mechanical Engineers, Paper Number C139/84, London.
- [21] **Liedl W and Denker D (1979)**. *The influence of road and tread pattern on tyre noise and skid resistance*. Proceedings of the International Tyre Noise Conference, Stockholm, Sweden.
- [22] **Nilsson N, Bennerhult O and Söderqvist S (1980)**. *External tyre/road noise; its generation and reduction*. Proceedings of Inter-Noise 80, Florida, Miami, USA, 245-252.
- [23] **Schaaf K and Ronnenberger D (1982)**. *Noise radiation from rolling tyres - Sound amplification by the "Horn-effect"*. Proceedings of Inter-Noise 82, San Francisco, California, USA, 131-134.
- [24] **Graf R A G, Kuo C-Y, Dowling A P and Graham W R (2002)**. *On the horn effect of a tyre/road interface, Part I: Experiment and computation*. Journal of Sound and Vibration **256**(3), 417-431.
- [25] **PIARC (1987)**. *Report of the Committee on Surface Characteristics*. XVIII World Road Congress, Brussels, Belgium, 1987.
- [26] **International Organisation for Standardisation (1997)**. *ISO 11819-1:1997. Acoustics – Method for measuring the influence of road surfaces on traffic noise – Part 1: The statistical pass-by method*. ISO, Geneva, Switzerland.



- [27] **Hewitt A P, Abbott P G and Nelson P M (1997).** *Alternative textures for concrete roads: Results of M18 and A50 trials.* TRL Report TRL291. TRL Limited, Crowthorne, UK.
- [28] **Attenborough K and Howarth C (1990).** *Models for the acoustical characteristics of porous road surfaces.* Proceedings of INTROOC 90 (International Tire/Road Noise Conference 1990), Gothenberg, Sweden, 177-191.
- [29] **Hamet J-F and Bérengier M (1993).** *Acoustic characteristics of porous pavements: a new phenomenological model,* Proceedings of Inter-Noise 93, Leuven, 1993, 641-646.
- [30] **Hamet J-F, Berengier M and Jacques M (1990).** *Acoustic performance of pervious surfaces.* Proceedings of INTROOC 90 (International Tire/Road Noise Conference 1990). Gothenburg, Sweden, 345-357.
- [31] **Descornet G (1990).** *Road-Surface Influence on Tire Rolling Resistance.* Surface Characteristics of Roadways: International Research and Technologies, ASTM STP 1031, W. E. Mayer and J. Reichert, Eds., American Society for testing and Materials, Philadelphia, pp. 401-415.
- [32] **Ejsmont J A, Taryma S, Mioduszewski P, Wozniak R, Ronowski G, Cwikla-Duda M and Wisiorek M (2005).** *Rolling resistance results.* SILVIA Project Report SILVIA-TUG-011-02-WP4-050114.
- [33] **Bendtsen H (2004)** *Rolling resistance, fuel consumption and emissions: A literature review.* SILVIA Project Report SILVIA-DTF-ATKINS-007-02-WP3-060204.
- [34] **Besnard F, Doisy S and Hamet J-F (2005).** *Acoustic durability of road surfaces: experimental observation on two techniques.* SETRA report. May 2005
- [35] **Franklin R E, Harland D G and Nelson P M (1979).** *Road surfaces and traffic noise.* TRRL Report LR 896. TRL Limited, Crowthorne, UK.
- [36] **Buber G (2000).** *Performance survey on open-graded friction course mixes.* National Cooperative Highway Research Programme, Synthesis of Highway Practice 284, Washington DC, USA.
- [37] **Kandhal P S (2000).** *Design, construction and maintenance of open-graded asphalt friction courses.* National Asphalt Pavement Association, Information Series 115, Lanham, USA.
- [38] **PIARC (1993).** *Les enrobés drainants – Porous asphalt.* World Road Association (PIARC), Paris, France.
- [39] **PIARC (1995).** *Flexible roads. Porous asphalt in practice.* Proceedings of PIARC XXth World Road Congress, Montreal, Canada, 47-87.
- [40] **Jacobsson T and Wågberg L G (1995).** *Inventering av dränerande asfaltbetong. Undersökning av borrhärnor (Inventory of porous asphalt. Investigation of core samples).* Swedish National Road and transport Research Institute (VTI), Linköping, Sweden.

- [41] **Descornet G (1988).** *Efficacité anti-bruit des enrobés drainants*. Proceedings of Roads and Traffic 2000, Berlin, Germany, **5**, 19-22.
- [42] **Phillips S M and Abbott (2001).** *Factors affecting statistical pass-by measurements*. Proceedings of Inter-Noise 2001, The Hague, The Netherlands, 2031-2036.
- [43] **Andersen B, Bendtsen H and Larsen L E (2005).** *Acoustic performance of low noise road pavements*. SILVIA Project Report SILVIA-DTF-DRI-010-02-WP4-290605.
- [44] **Laws D F (1998).** *Thin surface course materials*. Chapter 10, Asphalt surfacings (editor: J C Nicholls). E & FN Spon, London.
- [45] **AFNOR (2001).** XP P 98-137: *Enrobés hydrocarbonés - Couches de roulement : bétons bitumineux très minces - Définition - Classification - Caractéristiques - Fabrication - Mise en oeuvre*. AFNOR, Paris, France.
- [46] **Comité Européen de Normalisation (2005).** *EN 13108-2 - Bituminous mixtures - Materials specifications – Part 2: Asphalt concrete for very thin layers*. CEN, Brussels, Belgium.
- [48] **Valtonen J, Hyypä I and Sainio P (2002).** *Noise reduction vs wearing properties*. Proceedings of the Ninth International Conference on Asphalt Pavements, Copenhagen, Denmark.
- [50] **Wright M (1999).** *Thin layers – less noise*. Noise News 15. [www.wsanoise.com/information/Noisenews/15/Page4\\_t.html](http://www.wsanoise.com/information/Noisenews/15/Page4_t.html)
- [51] **Comité Européen de Normalisation (2005b).** *prEN 13108-5: Bituminous mixtures – Material specifications – Part 5: Stone mastic asphalt*. CEN, Brussels, Belgium.
- [52] **European Asphalt Pavement Association (1998).** *Heavy duty surfaces: the arguments for SMA*. European Asphalt Association, Breukelen, ISBN 90-801214-8-7, The Netherlands.
- [53] **Forschungsgesellschaft für Strassen- und Verkehrswesen (2000).** *Merkblatt für die Herstellung von Oberflächentexturen auf Fahrbahndecken aus Beton (M OB). (Instructions concerning the manufacture of surface textures on concrete surface pavement)*. M OB (2000 edition)
- [54] **Krieger and Sulten (1999).** *Stand der Entwicklung von lärmarmen Betondecken (Current state of development of low-noise concrete pavement)*. Straße and Autobahn **9**.
- [55] **Chandler J W E, Phillips S M, Roe P G and Viner H (2003).** *Quieter concrete roads: construction, texture, skid resistance and noise*. TRL Report 576. TRL Limited, Wokingham, UK.

- [56] **Steigenberger J (2002)**. *Waschbetonoberfläche (Exposed aggregate cement concrete surface)*. Proceedings of the Conference Betonfahrbahnen, Olomouce, Czech Republic.
- [57] **Litzka J and Haberl J (2005)**. *Bewertung der Nahfeld- Geräuschemission österreichischer Fahrbahndeckschichten (Evaluation of near field noise emissions on Austrian pavements)*. Final project report, BMVIT, Vienna, unpublished.
- [58] **Decornet G (1979)**. *Experimental study of the rolling noise of a test car on various existing road surfaces in Belgium*. Proceedings of the International Tire Noise Conference, Stockholm, 205-218.
- [59] **Spits P L (1990)**. *Open beton voor minder verkeersgeluid*. Cement 3.
- [60] **Sommer H (1990)**. *Herabsetzung des rollgeräusches bei betonfahrbahndecken*. Zement & Beton 3/90.
- [61] **Iwai S, Miura Y, Yokokawa T and Kobayashi H (1990)**. *Tire/road noise reduction effects of porous pavement and Pavetex pavement*. Proceedings of the International Tire/Road Noise Conference 1990, Gothenburg, Sweden.
- [62] **Kuemmel D A, Jaeckel J R and Satanovsky A (2000)**. *Investigative Study of the Italgrip System: Noise Analysis*. WisDOT Report WI/SPR-02-00, Wisconsin DOT, 3502 Kinsman Blvd. Madison, WI 53704, USA.
- [63] **Pucher E (1998)**. *Optimisation of the system car tyre road – the sound of silence*. Vienna University of Technology, Vienna, Austria.
- [64] **Schwarz R (1998)**. *Systematische Erfassung der Einflüsse von Fahrban-, Reifen-, und Fahrzeugparametern auf das Aussengeräusch von Pkw (Systematic Analysis of the Influence of Road Surface, Tyre and Vehicle Parameters on the Exterior Noise of Passenger Cars)*. Doctoral Dissertation, Vienna University of Technology, Vienna, Austria.
- [65] **VBW Asphalt (1993)**. *ZOAB – Zeer open asfaltbeton (ZOAB – Very open asphalt concrete)*. VBW Asphalt, Breukelen.
- [66] **Svedala Dynapac (2000)**. *Compaction and paving – Theory and practice*. Publication No. IHCCCAPEN1, Svedala Dynapac, Sweden.
- [67] **Rudolf E and Floss H (2001)**. *Compaction technology in earthwork and highway and transportation engineering*. Bomag GmbH & Co. OHG, Boppard, Germany.
- [68] **National Asphalt Pavement Association (2002)**. *Design, construction and maintenance of open-graded asphalt friction courses*. Information Series 115. NAPA, Lanham, MD, USA.
- [69] **Sandberg U (2005)**. *Japanese machines for laying and cleaning of double-layer porous asphalt – Observations from a study tour*. Report prepared for the Dutch IPG programme. Swedish National Road and Transport Research Institute (VTI), Linköping, Sweden.

- [70] **Nilsson R and Fliedner J (2004).** *Improved quality using modern machine guidance system report on the worksite evaluation and economical impact.* Proceedings of the 3<sup>rd</sup> Euroasphalt & Eurobitume Congress, Vienna, Austria. Paper No.104.
- [71] **Hooimeijer R H (2001).** *Rijstrookbrede en rijbaanbrede onderhoudsstrategieën.* DWW Project Report DWW-2001-019. DWW, Delft, The Netherlands.
- [72] **van Gent R J and Sule M S (2004).** *Evaluatie van VIA-RAL onderhoudstechniek voor ZOAB.* DWW Project Report DWW-2004-99. DWW, Delft, The Netherlands.
- [73] **Sanders P (2005).** *Review of recycling and rejuvenation procedures.* SILVIA Project Report SILVIA-TRL-016-02-WP4-240605.
- [74] **Bendtsen H and Larsen L E (2002).** *Two-layer porous pavements and noise reductions in Denmark.* Proceedings of the 9<sup>th</sup> International Conference on Asphalt Pavements (ISAP), Copenhagen, Denmark.
- [75] **Takahashi S and Partl M N (1999).** *Improvement of mix design for porous asphalt.* Eidgenössischen Materialpriifungs- und Forschungsanstalt, Report 113/11, Dlibendorf, Switzerland.
- [76] **Matsuda T, Inagaki T and Masuyama Y (1998).** *Investigation and examination concerning function recovery of drainage asphalt pavement.* Proceedings of the 9<sup>th</sup> Road Engineering Association of Asia and Australasia Conference, Wellington, New Zealand.
- [77] **Organisation of Economic Cooperation and Development (1995).** *Roadside noise abatement.* Report prepared by an OECD Scientific Expert Group, OECD, Paris, France.
- [78] **Sanches F (1994).** *Development of a new (air) permeabilitymeter for porous asphalt courses.* (in Dutch). Report No. W-DWW-94-512. Directorate-General of Public Works and Water Management (DWW), Delft, The Netherlands.
- [79] **DWW (1991).** *Onderzoek naar de snelheid van vervuilen van zeer open asfaltbeton.* Internal memo MAA-S-91008, DWW Afdeling adviezen, 17-1-1991.
- [80] **Sanches F (2000).** *Doordatendheidsmetingen op ZOAB voor en na reinigen in Dienstkring Drenthe.* DWW-2000-063. DWW, Delft, The Netherlands.
- [81] **Steven A, Minsk L, Blackburn R and Fleege J (1996).** *Manual of practice for an effective anti-icing program.* U.S. Department of Transportation, Federal Highway Administration, Publication No. FHWA-RD-95-202, Virginia, USA.
- [82] **DWW (2002).** *Basic level of maintenance of the network of main roads in the Netherlands.* Ministry of Transport, Public Works and Water Management. The Netherlands.
- [83] **Skerlan M (2001).** *Winter Maintenance in Austria - A short survey of the winter maintenance practice in Austria.* Report of the COST 344 project (Improvements to Snow and Ice Control on European Roads and Bridges). <http://www.tu-darmstadt.de/fb/bi/ifv/sw/cost344/cost.tud>

- [84] **Holldorb C (1997).** *Beitrag zur Bewertung des Einsatzes offenporiger Asphalt-deckschichten auf Autobahnen.* Technische Universität Darmstadt, Fachbereich Bauingenieurwesen D 17, Darmstadt, Germany.
- [85] **Page G C (1993).** *Open-graded friction courses: Florida's experience.* Transportation Research Record **1427**, 1-4.
- [86] **Litzka J (1997).** *Austrian experiences with porous asphalt.* European Conference on Porous Asphalt, 988-1005.
- [87] **Norrts M (1996)** *Winter maintenance on porous asphalt.* Conference Proceedings 16, 'Snow Removal and Ice Control Technology' TRB (Transportation Research Board), Washington DC.
- [88] **Pracherstorfer W and Litzka J (1994).** *Österreichische erfahrungen mit lärmindernden deckschichten (Austrian experiences with low noise pavements).* BMA (Federal Ministry of Economics and Labour of the Republic of Austria), ISSN 0379-1491, Vienna, Austria.
- [89] **Coventry S, Woolveridge C and Hillier S (1999).** *The reclaimed and recycled construction materials handbook.* CIRIA Report No. C513. CIRIA, London.
- [90] **Button J W, Estakhri C K and Little R C (1999).** *Overview of hot in-place recycling of bituminous pavements.* Transportation Research Record **1684**. National Academy Press, Washington DC.
- [91] **Colas Limited (2001).** Products description, [www.colas.co.uk](http://www.colas.co.uk)
- [92] **Huffman J E (1998).** *Update on asphalt recycling, reclamation.* Better roads, July 1998. Illinois.
- [93] **Hicks B (1996).** *Recycling in-roads.* Surveyor, 16 May 1996. The Hemming Group Limited, London.
- [94] **van Bochove G G (1996).** *Twin-lay, a new concept for porous asphalt.* Proceedings of the 1st Eurasphalt and Eurobitume Congress, Strasbourg, France. Paper No. 7187.
- [95] **Vos E, Morgan P A and Nijland R (2004).** *The Dutch noise innovation program road traffic (IPG).* Proceedings of Inter-Noise 2004, Prague, Czech Republic. Paper No. 686.
- [96] **Morgan P A (2004).** *Scientific strategy document - November 2004.* IPG Project Report DWW-2004-080, November 2004. Road and Hydraulic Engineering Division, Rijkswaterstaat, Delft, The Netherlands.
- [97] **Bendtsen H (1998).** *Drainage asphalt and noise reduction over a long period.* Proceedings of EuroNoise 1998, Munich, Germany.
- [98] **Bendtsen H, Andersen B, Råberg J and Larsen L E (2005).** *Two-layer porous asphalt for urban roads.* Proceedings of Forum Acusticum 2005, Budapest, Hungary.

- [99] **Hofman R, van Wieringen J B M and Visser J C (2005).** *Noise innovation program IPG: Two layer porous asphalt for use on the Dutch main highway network.* Proceedings of Inter-Noise 2005, Rio de Janeiro, Brazil, August 2005.
- [100] **Goubert L, Hooghwerff J, The P and Hofman P (2005).** *Two-layer porous asphalt: An international survey in the frame of the Noise Innovation Programme (IPG).* Proceedings of Inter-Noise 2005, Rio de Janeiro, Brazil, August 2005.
- [101] **Riffel S (1996).** *Deckschichten aus dränbeton – eine ökologische bauweise.* Strasse + Autobahn 11/96, 653-659.
- [102] **Brosseaud Y and Anfosso-Lédée F (2005).** *Review of existing low-noise pavement solutions in France.* SILVIA Project Report SILVIA-LCPC-011-01-WP4-310505.
- [103] **Nicholls J C (2001).** *Material performance of porous asphalt, including when laid over concrete.* TRL Report 499. TRL Limited, Wokingham, UK.
- [104] **Nicholls J C and Carswell I G (2001).** *The design of porous asphalt mixtures to performance-related criteria.* TRL Report 497. TRL Limited, Wokingham, UK.
- [105] **Nicholls J C (1997)** *Review of UK porous asphalt trials.* TRL Report 264, TRL Limited, Wokingham. UK.
- [106] **Comité Européen de Normalisation (1997).** *prEN 12697-17. Test method for hot mix asphalt: Determining the particle loss from porous asphalt.* CEN, Brussels, Belgium.
- [107] **Nicholls J C and Carswell I G (2004).** *Durability of thin asphalt surfacing systems. Part 2: Findings after three years.* TRL Report 606. TRL Limited, Wokingham, UK.
- [108] **British Board of Agrément (2004).** *Guidelines document for the assessment and certification of thin surfacing systems for highways.* SG3/05/234. British Board of Agrément, Garston, United Kingdom.
- [109] **Bendtsen H et al (2004).** *Måling af trafikstøj fra vejbelægninger på M10 ved Solrød. (Measurement of noise from pavements on M10 near Solrød, in Danish).* Eksternt notat 21, 2004. Danish Road Institute, Road Directorate.
- [110] **Sandberg U, Kalman B and Nilsson R (2005).** *Design guidelines for construction and maintenance of poroelastic road surfaces.* SILVIA Project Report SILVIA-VT-005-02-WP4-141005.
- [111] **Sandberg U and Kalman B (2005).** *The poro-elastic road surface – Results of an experiment in Stockholm.* Proceedings of Forum Acusticum 2005, Budapest, Hungary.
- [112] **Fujiwara T, Meiarashi S, Namikawa Y and Hasebe M (2005).** *Noise reduction effect of porous elastic road surface and drainage asphalt pavement.* TRB paper 05-0451 presented at the TRB Annual Meeting 2005, Washington, DC, USA.

- [113] **International Organisation for Standardisation (2000)**. *ISO/CD 11819-2: 2000. Acoustics – Method for measuring the influence of road surfaces on traffic noise – Part 2: The close proximity method*. ISO, Geneva, Switzerland.
- [114] **International Organisation for Standardisation (1998)**. *ISO 10534-2:1998: Acoustics – Determination of sound absorption coefficients and impedance in impedance tubes – Part 2: Transfer function method*. ISO, Geneva, Switzerland.
- [115] **International Organisation for Standardisation (2002)**. *ISO 13472-1:2002. Acoustics – measurement of sound absorption properties of road surfaces in-situ – Part 1: Extended surface method*. ISO, Geneva, Switzerland.
- [116] **Hamet J-F and Klein P (2005)**. *ENR<sub>a</sub>, Expected pass-by noise level reduction from acoustic absorption of the road surface*. SILVIA Project Report SILVIA-INRETS-018-02-WP2-040505.
- [117] **International Organisation for Standardisation (1997)**. *ISO 13473-1:1997. Characterization of pavement texture by use of surface profiles – Part 1: Determination of Mean Profile Depth*. ISO, Geneva, Switzerland.
- [118] **International Organisation for Standardisation (2002)**. *ISO 13473-2:2002. Characterization of pavement texture by use of surface profiles – Part 2: Terminology and basic requirements related to pavement texture profile analysis*. ISO, Geneva, Switzerland.
- [119] **International Organisation for Standardisation (2002)**. *ISO 13473-3:2002. Characterization of pavement texture by use of surface profiles – Part 3: Specification and classification of profilometers*. ISO, Geneva, Switzerland.
- [120] **International Organisation for Standardisation (2004)**. *ISO/CD TS 13473-4. Characterization of pavement texture by use of surface profiles – Part 4: Spectral analysis of texture profiles*. ISO, Geneva, Switzerland.
- [121] **Klein P and Hamet J-F (2005)**. *END<sub>T</sub>, Expected pass-by noise level difference from texture level variation of the road surface*. SILVIA Project Report SILVIA-INRETS-021-01-WP2-070705.
- [122] **Kuijpers A H W M and Schwanen W (2005)**. *Development of a measurement system for mechanical impedance*. SILVIA Project Report SILVIA-M+P-013-01-WP2-230605.
- [123] **International Organisation for Standardisation (1991)**. *ISO 9053: 1991. Acoustics - Materials for acoustical applications – Determination of airflow resistance*. ISO, Geneva, Switzerland.
- [124] **Stinson M and Daigle G (1988)**. *Electronic system for the measurement of flow resistance*. *Journal of the Acoustical Society of America* **83**(6), 2422-2428.
- [125] **CROW (2004)**. *De methode Cwegdek 2002 voor wegverkeersgeluid*. Publicatie 200, April 2004. CROW, Ede, The Netherlands.
- [126] **Bundesministerium für Verkehr (1990)**. *RLS-90 - Richtlinien für den Lärmschutz an strassen*. Forschungsstelle für trassen- und Verkehrswesen, Köln, Germany.

- [127] **Bundesministerium für Verkehr (1991).** *ARS-91 - Allgemeines Rundschreiben Straßenbau Nr. 14/1991.* Bundesministerium für Verkehr, Köln, Germany.
- [128] **Bundesministerium für Verkehr (1992).** *GEStro-92 - Verfahren zur Messung der Geräuschemission von Strassenoberflächen.* Anlage zum ARS 16/1992. Bundesministerium für Verkehr, Köln, Germany.
- [129] **Elvik R and Greibe P (2005).** *Safety aspects related to low noise road surfaces.* SILVIA Project Report SILVIA-DTF-ATKINS-001-03-WP3-091203.
- [130] **Veisten K and Saelensminde K (2004).** *Summary of net impacts on sustainability from a change to porous asphalt.* SILVIA Project Report SILVIA-TOI-002-06-WP3-300304.
- [131] **Parry A R and Viner H E (2005).** *Accidents and the skidding resistance standard for strategic roads in England.* TRL Report TRL622. TRL Limited, Wokingham, UK.
- [132] **Nicholls J C and Daines M E (1992)** *Spray suppression by porous asphalt.* The Second International Symposium on Road Surface Characteristics.
- [133] **Edwards J B (2002).** *Motorway speed in wet weather: the comparative influence of porous and conventional asphalt surfacings.* Journal of Transport Geography 10, 2002.
- [134] **Delanne Y, Laganier R, Christophe T, Gondoni N, Duboil C and Begou P A (1991).** *Skid resistance of drainage asphalt. Stopping distances.* LCPC, September 1991.
- [135] **Bonnot J (1997).** *French experiences of porous asphalt.* Proceedings of European Conference on Porous Asphalt 1997.
- [136] **Ragnøy A (1989).** *Trafikksikkerhet og drengasfalt.* Arbeidsdokument TST/0143/89. Transportøkonomisk institutt, Oslo.
- [137] **Henry J (2000).** *Evaluation of the Italgrip system.* High Innovative Technology Evaluation Center, Washington DC (copy of report available from Italgrip).
- [138] **Descornet G (1989).** *A criterion for optimizing surface characteristics.* Transportation Research Record 1215, 173-177.
- [139] **James E (2003).** *A literature review on the effect of porous asphalt roads on water pollution.* SILVIA Project Report SILVIA-TRL-008-01-WP3-240703.
- [140] **Berbee R, Rijis G, de Brouwer R and van Velzen L (1999).** *Characterization and treatment of runoff from highways in the Netherlands paved with impervious and pervious asphalt.* Water Environment Research 71(2) (March-April): 183-190.
- [141] **Pagotto C, Legret M and Le Cloirec P (2000)** *Comparison of the hydraulic behaviour and the quality of highway runoff water according to the type of pavement.* Water Resources 34(18): 4446-4454.



- [142] **van der Zwan J, Goeman T, Gruis H, Swart J and Oldenburger R (1990)** *Porous asphalt wearing courses in the Netherlands: State-of-the-art review*. Transportation Research Record 1265, TRB, National Research Council, Washington D.C., pp. 95-110.
- [143] **Descornet G, Gorle D, Heyns W, Lanoye L, Lefebvre G, van Langenhove W and Verhasselt, A. (1998)** *Stratégie d'entretien pour les enrobés drainantes*. Rapport d'un groupe de travail LIN-MET-CRR. CR 39/98, Centre de Recherches routières, Brussels.
- [144] **Pucher E, Litzka J, Haberl J and Girard J (2004)**. *Report on recycling of porous asphalt in comparison with dense asphalt*. SILVIA Project Report SILVIA-TUW-036-01-WP3-260204.
- [145] **Saelensminde K and Veisten K (2005)**. *Cost-benefit analysis*. SILVIA Project Report SILVIA-TOI-004-01-WP3-030505.
- [146] **Navrud, S (2002)**. *The state-of-the-art on economic valuation of noise*, Final Report to European Commission DG Environment, 14 April 2002, Department of Economics and Social Sciences, Agricultural University of Norway.
- [147] **Larsen L E and Bendtsen H (2002)**. *Noise reduction with porous asphalt*, Paper presented at the 9<sup>th</sup> International Conference on Asphalt Pavements, Copenhagen 2002.
- [148] **EUNET (2001)**. *EUNET, Socio-economic and spatial impacts of transport*. The EUNET/SASI Final Report. Marcial Echenique and Partners Ltd, Cambridge, UK.
- [149] **World Health Organisation (2004)**. *The World Health Report 2004: Changing history*. WHO, Geneva, Switzerland.
- [150] **Haberl J, Lengheim T, Pucher E, Litzka J, Bendtsen H, Watts G, Parry A, Anfosso-Lédée, Sandberg U, Lelong J, Hamet J-F, van Blokland G J, Kuijpers A, Ejsmont J and Mioduszewski P (2005)**. *Integration of low-noise pavements with other noise abatement measures*. SILVIA Project Report SILVIA-TUW-052-04-WP5-220305.
- [151] **Haberl J, Pucher E, Litzka J and Kalivoda M, (2003)**. *Reale lärm-emissionsfaktoren des straßenverkehrs und reduktionsszenarien durch gesamtsystemoptimierung (Real-life noise emissions factors for street traffic and noise reduction scenarios through complete system optimisation)*. Final Report of the Austrian Advanced Automotive Technology A3 Programme, FFF Project No. 806215, Vienna, Austria.
- [152] **International Organisation for Standardisation (1991)**. *ISO 10844: 1991, Acoustics – Specification of test tracks for the purpose of measuring noise emitted by road vehicles*. ISO, Geneva, Switzerland.
- [153] **Jonasson H, Sandberg U, van Blokland G, Ejsmont J, Watts G and Luminari M (2004)**. *Source modelling of road vehicles*. Deliverable D9 of the HARMONOISE project. [www.imagine-project.org](http://www.imagine-project.org)

- [154] **Pucher E and Haberl J (2004).** *Reduktionspotenzial des straßenverkehrslärms – Reales lärmverhalten und beurteilung (Potential of traffic noise reduction – estimation of the real-life traffic noise behaviour)*. Lecture in the context of the event “Road Construction Engineering”. Vienna University of Technology, Institute for Road Construction and Maintenance, June 2004, Vienna, Austria.
- [155] **Pucher E, Litzka J, Haberl J, Girard J, Ejsmont J, Lelong J, Hamet JF, Sandberg U, Bendtsen H, Watts G, Parry A, van Blokland G and Kuipers A (2004).** *Recommendations on specifications for tyre and vehicle requirements*. SILVIA Project Report SILVIA-TUW-039-02-WP5-120304.
- [156] **Anfosso-Lédée F, Haberl J and Watts G (2005).** *Combination of low-noise road surfaces with road and building equipment*. SILVIA Project Report SILVIA-LCPC\_TUW-009-02-WP5-020205.
- [157] **van Blokland G and Roovers M S (2005).** *Measurement methods*. SILVIA Project Report SILVIA-M+P-015-03-WP2-120905.
- [158] **Davies O L and Goldsmith P L (Editors) (1980).** *Statistical methods in research and production*. ICI, Fourth revised edition. Longman Group Limited, London and New York.
- [159] **Beckenbauer Th et al. (2005).** *Einfluss der fahrbahntextur auf das reifen-fahrbahn-geräusch*, Forschung Straßenbau und Straßenverkehrstechnik, Heft 847, Bonn 2005.
- [160] **Berengier M, Pichaud Y and Le Fur J-F (2000).** *Effect of low noise pavements on traffic noise propagation over large distances: influence of ground and atmospheric conditions*. Proceedings of Internoise 2000, Nice, France.
- [161] **Roovers M S (2005).** *SPB study*. SILVIA Project Report SILVIA-M+P-011-00-WP2-230205.
- [162] **Dulau B, Doisy S and Haettel J P (2001).** *Mesures “au passage” du bruit de contact pneumatique-chaussée: Méthodologie, application à l’évaluation des performances acoustiques des revêtements routiers*. Bulletin de Liaison des Ponts et Chaussées **4277**, Thématique acoustique, LCPC, 71-84.
- [163] **Anfosso-Lédée F (2003).** *A former LCPC experimental campaign about repeatability and reproducibility of SPB and CPB measurement methods*. SILVIA Project Report SILVIA-LCPC-002-00-WP2-170403.
- [164] **van Blokland G J, van Houten M H, van Loon R, Steven H, Küppers D (2000).** *International Validation test for the ‘Close Proximity Method’ (CPX)*, May 2000.
- [165] **Roovers M S and Peeters H M (2004).** *CPX-SPB/CPB relation*. SILVIA Project Report SILVIA-M+P-008-00-WP2-080904.
- [166] **Anfosso-Lédée F (2004).** *The propagation filter between CPX and CPB measurements*. SILVIA Project Report SILVIA-LCPC-006-01-WP2-300404.

- [167] **Anfosso-Lédée F (2004)**. *Modelling local propagation effects of tire-road noise: Propagation filter between CPX and CPB measurements*. Proceedings of Inter-Noise 2004, Prague, Czech Republic. Paper No. 493.
- [168] **Roovers M S (2005)**. *Round-robin test for measurements devices on road acoustics*. SILVIA Project Report SILVIA-M+P-009-03-WP2-230605.
- [169] **Ejsmont J A, Mioduszewski P, Gardziejczyk W, Wisiorek A, Sandberg U, Padmos C, Roovers M S, Morgan P and Anfosso-Lédée F (2004)**. *Development of procedures for certifying noise testing equipment*. SILVIA Project Report SILVIA-TUG-006-10-WP2-160104.
- [170] **Ejsmont J (Editor) 2005**. *Development of procedures for certifying noise testing equipment*. Gdansk University of Technology, Poland.
- [171] **Abbott P and Watts G (2005)**. *Correlating statistical pass-by (SPB) and close-proximity (CPX) noise levels*. Proceedings of the Inter-Noise 2005, Rio de Janeiro, Brazil.
- [172] **Morgan P A and Watts G R (2003)**. *A novel approach to the acoustic characterisation of porous road surfaces*. Applied Acoustics **64**(12) 1171-1186.
- [173] **Morgan P A (2005)**. *Performing static and dynamic measurements of the absorption coefficient of low-noise road surfaces using the extended surface method*. SILVIA Project Report SILVIA-TRL-007-05-WP2-010405.
- [174] **Klein P & Hamet J-F (2000)**. *Road texture and tire noise*. Proceedings of Inter-noise 2000, Nice, France. Paper No. 674.
- [175] **Beckenbauer T & Kuijpers A (2001)**. *Prediction of pass-by levels depending on road surface parameters by means of a hybrid model*. Proceedings of Inter-Noise 2001, The Hague, the Netherlands. Paper No. 717.
- [176] **Klein P and Hamet J-F (2004)**. *Road texture and rolling noise. An envelopment procedure for tire/road contact*. Technical report LTE 0427. INRETS, France.
- [177] **Pruvost M (1996)**. *Indentation d'un massif de gomme élastique par un profil rigide.*, Technical report MMA 9606. INRETS, France.
- [178] **Kalker J J (1982)**. *Introduction to the Fortran IV programs Duvorol and contact for the solution of 30 elastostatic Half-space contact problems with and without friction*. Technical report, Department of Mathematics and Informatics. Technical University of Delft.
- [179] **Poinas P (1994)**. *Contact pneumatique chaussée - Adaptation au contact bidimensionnel de la méthode de résolution numérique de Kalker*. Technical report MMA 9408, INRETS, France.
- [180] **Cesbron J and Anfosso-Lédée F (2005)**. *A characterization method of road stiffness for tyre/road noise*. SILVIA Project Report SILVIA-LCPC-010-01-WP2-020505.

- [181] **Cesbron J and Anfosso-Lédée F (2005).** *A characterization method of road stiffness for tyre/road noise.* Proceedings of Inter-Noise 2005, Rio de Janeiro, Brazil.
- [182] **Nilsson N and Sylwan O (2003).** *New vibro-acoustical measurement tools for characterization of poroelastic road surfaces with respect to tyre/road noise.* Tenth International Congress on Sound and Absorption, Stockholm, Sweden, 7-10 July 2003.
- [183] **Roovers M S et al. (2005).** *Round robin test rolling resistance/energy consumption.* M+P Project Report M+P.DWW.04.19.1 revision 5.
- [184] **Hübelt J, Schmidt H, Bartolomaeus W and Wellner F (2005).** *Über die korrelation von fahrzeuggeräuschpegeln mit in situ gewonnenen messergebnissen zum strömungswiderstand, zur wasserdurchlässigkeit und zum absorptionsgrad von offenporigen asphalten,* DAGA 2005, München 2005.
- [185] **Mioduszewski P, Gardziejczyk W and Wisiorek M (2005).** *Repeatability and reproducibility of CPX round-robin test.* SILVIA Project Report SILVIA-TUG-007-04-WP2-120505.
- [186] **Highways Agency and Britpave (2001).** *Concrete pavement maintenance manual.* Crowthorne: The Concrete Society.
- [187] **Highways Agency, the Scottish Executive Development Department, the National Assembly for Wales (Cynulliad Cenedlaethol Cymru) and the Department for Regional Development (a Government Department in Northern Ireland).** *Design Manual for Roads and Bridges.* The Stationary Office, London, UK.
- Volume 7. Pavement Design and Maintenance
    - HD 30 *Structural assessment procedure.*
    - HD 31 Maintenance of bituminous roads.
    - HD 32 Maintenance of concrete roads.
    - HD 37 Bituminous surfacing materials and techniques.
- [188] **Hultqvist B-Å (1994).** *Improvement of evenness and surface texture on Swedish concrete roads.* Proceedings of third sprint workshop, exhibition and demonstrations on technology transfer and innovation in road construction. Swedish national state of the art report. Nr 208. Edited by LG Wågberg.
- [189] **Mosher L (1997).** *Concrete pavement defects, causes and solutions.* Pavement Maintenance 12(1) 30-34.
- [190] **Darter M I (1988).** *Maintenance of Portland cement concrete pavements.* Department of Civil Engineering University of Illinois, Urbana, Illinois, USA, 247-277.
- [191] **Pierce LM (1997).** *Design, construction, performance and future direction of dowel bar retrofit in Washington State.* Proceedings of 6<sup>th</sup> International Conference on Concrete Pavement Design and Rehabilitation, Purdue, 87-100.
- [192] **Congress N and MI Darter (1991).** *Portland cement concrete pavements: rehabilitation challenges and recommendations.* Public roads, 55 (2) 46-52.

- [193] **Department of the Environment, Transport and the Regions (2000).** *Transport 2010: The ten year plan.* The Stationery Office, London, UK.
- [194] **Potter JF and J Mercer (1996).** *Performance of the crack and seat method of inhibiting reflection cracking.* Proceedings of the third RILEM conference on Reflective Cracking in Pavements. E & FN Spon, London.
- [195] **Langdale P (2000).** *Maintenance techniques to control reflection cracking in overlays to reinforced concrete pavements.* TRL Project Report PR/IP/55/00. Transport Research Laboratory, Crowthorne, UK. (Unpublished report).
- [196] **Ksaibati PE, W Miley and J Armaghani (1998).** *Rubblization of concrete pavements.* A paper prepared for the annual meeting of Transportation Research Board. August 1998.
- [197] **Yrjanson WA (1989).** *Recycling of Portland cement concrete pavements.* National Cooperative Highway Research Program 154, 1-2.
- [198] **Bendtsen H, Haberl J, Sandberg U, Watts G and Pucher E (2005).** *Traffic management and noise reducing pavements – Recommendations on additional noise reducing measures.* SILVIA Project Report SILVIA-DTF-DRI-08-11-WP5-020205.
- [199] **Padmos C, Morgan P, Abbott P, van Blokland G, Roovers M S, Bartolomaeus W and Anfosso F (2005).** *Classification scheme and COP method.* SILVIA Project Report SILVIA-DWW-025-014-WP2-151005.
- [200] **Chandler J W E, Phillips S M, Roe P G and Viner H (2003).** *Quieter concrete roads: construction, texture, skid resistance and noise.* TRL Report 576. TRL Limited, Wokingham, UK.
- [201] **Nilsson R, Nordlander JO and Silwa N (2005).** *Design guidelines for durable, noise reducing pavements.* SILVIA Project Report SILVIA-SKANSKA-018-01-WP4-231105.



## Glossary of terms

**Absorption coefficient:** The sound-absorption coefficient of a surface, which is exposed to a sound field, is the ratio of the sound energy absorbed by the surface to the sound energy incident upon the surface. The absorption coefficient is a function of both angle of incidence and frequency. Tables of absorption coefficient which are given in the literature usually list the absorption coefficients at various frequencies.

**Accuracy:** Closeness of the agreement between the result of a measurement and a true value of the measure (CEN).

**Acoustic Impedance:** The acoustic impedance of a surface is defined in the frequency domain. It is the complex ratio of the acoustic pressure on that surface by the acoustic volume velocity through the surface. The acoustic impedance is defined locally and may vary from one point to the other.

**Aggregate:** Granular material used in construction.

**Air-pumping:** Air pumping is one of the phenomena implied in tyre/road noise generation. It is created by successive compression and release of air volumes at the entrance and the exit of the tyre/road contact zone. Air pumping noise is reckoned to be radiated in the medium and high frequency range (800 Hz and above).

**A-weighting:** Human hearing is less sensitive at very low and very high frequencies. In order to account for this, weighting filters can be applied when measuring sound. A-weighting, which provides results often denoted as dB(A), conforms approximately to the human ear.

**Annoyance:** The sensation of discontent, referring to the noise which an individual knows or thinks can affect him in a negative sense.

**Attenuation:** The lessening of energy over time or distance.

**Band Pressure Level:** The band pressure level of a sound for a specified frequency band is the effective sound pressure level for the sound energy contained within that band. The width of the band and the reference pressure must be specified. The width of the band may be indicated by the use of a qualifying adjective, e.g. octave-band (sound pressure) level, half-octave band level, third-octave band level and 50 Hz band level, etc.

**(Bituminous) Binder:** An adhesive material containing bitumen or asphalt or mixtures of such.

**Braking Force Coefficient:** A coefficient characterizing the skid resistance of the surface in the longitudinal direction of a road (in wet condition if not otherwise specified), generally expressed for a given speed. It is the ratio between the horizontal reaction force and the vertical load on a vehicle wheel that is locked or retarded to some degree.

**Course:** A structural element of a pavement constructed with a single material. It may be laid in one or more layers.

**Decibel:** The decibel is a unit of level which denotes the ratio between two quantities that are proportional to power; the number of decibels corresponding to the ratio of two amounts of power is 10 times the logarithm to the base 10 of this ratio.

**Frequency:** Inverse of the (shortest) time interval between periodically repeated parts of a sinusoidal signal.

**Gap Grading:** Characteristic of an aggregate graded without one or more of the intermediate sizes.

**Hertz (Hz):** Unit of frequency, equal to one cycle per second.

**Impedance:** Impedance is the complex ratio of a force-like quantity (force, pressure, voltage) to a related velocity-like quantity (velocity, volume velocity, current).

**Loudness:** Subjective perception by people of how strong is a sound. It can be expressed in Phons or Sones, two related scales.

**Macrotexture:** (1) Surface irregularities of a road pavement with horizontal dimensions ranging between 0.5 and 50 mm and vertical dimensions between 0.2 and 10 mm. Macrotexture is related to aggregate size, mixture design and laying (compaction), as well as to the surface treatment applied (if any). It has wavelengths in the same order of size as tyre tread elements in the tyre-road interface (PIARC); (2) Deviation of a pavement surface from a true planar surface with the characteristic dimensions along the surface of 0.5 mm to 50 mm, corresponding to texture wavelengths with one-third-octave bands including the range 0.63 mm to 50 mm of centre wavelengths (ISO, CEN).

**Mean Texture Depth:** The distance between the textured road surface and a plane through the peak of the three highest particles within a surface area of the same order of size as the tyre pavement area (ISO). Notes: 1. Mean texture depth (MTD) is generally expressed as the quotient of a given volume of standardized material [sand ("sand patch test"), glass spheres] and the area of that material spread in a circular patch on the surface being tested. 2. Mean texture depths calculated from height measurements in other types of test (rather than from the patch test) are sometimes referred to as "sensor-measured texture depth" (PIARC).

**Mechanical Impedance:** The mechanical impedance of a surface is defined in the frequency domain. It is the complex ration of the force applied on an element of the surface by the velocity of that surface element. The acoustic impedance is defined locally and may vary from one point to the other.

**Megatexture:** (1) Surface irregularities of a road pavement with horizontal dimensions ranging between 50 and 500 mm and vertical dimensions between 10 and 50 mm. This type of texture has wavelengths in the same order of size as a tyre-road interface (PIARC); (2) Deviation of a pavement surface from a true planar surface with the characteristic dimensions along the surface of 50 mm to 500 mm, corresponding to texture wavelengths with one-third-octave bands including the range 63 mm to 500 mm of centre wavelengths (ISO, CEN).

**Microtexture:** (1) Surface irregularities of a road pavement with horizontal dimensions ranging between 0 and 0.5 mm and vertical dimensions between 0 and 0.2 mm. Microtexture is related to the asperities of the coarse aggregate, the sand particles and the road surface in contact with the rubber of tyres. It makes the surface feel more or less



harsh but is normally too small to be observed by the eye (PIARC). (2) Deviation of a pavement surface from a true planar surface with the characteristic dimensions along the surface of less than 0.5 mm, corresponding to texture wavelengths up to 0.5 mm expressed as one-third-octave centre wavelengths (ISO, CEN).

**Noise:** Unwanted sound.

**Noise Level:** The magnitude of sound pressure in decibels on the A scale.

**Open grading:** Aggregate specification for a high void content.

**Peak Level:** The maximum noise level measured when a vehicle is passing by a fixed microphone.

**Porosity:** Synonymous of voids content i.e. the ratio of the volume of voids to the whole volume of a mix (generally expressed as a percentage).

**Power Spectrum:** For a given signal, the power spectrum gives a plot of the portion of a signal's power (energy per unit time) falling within given frequency bands.

**Precision:** The smallest detectable variation in a measurement.

**Ravelling:** The loosening of stones from the surface of a pavement.

**Repeatability:** The variation in measurements obtained when one person measures the same unit with the same measuring equipment.

**Reproducibility:** The variation in average measurements obtained when two or more people measure the same parts or items using the same measuring technique.

**Roughness:** Synonym of "unevenness" in USA.

**Sideways Force Coefficient:** A coefficient characterizing the skid resistance of the surface in the transverse direction of a road, expressed as the ratio between the force perpendicular to the rotation of a wheel and the normal reaction of the road surface under the wheel load. The wheel is at an angle ("yaw angle") to the direction of movement (PIARC).

**Skid Resistance:** The property of the trafficked surface that develops friction between a moving tyre and the pavement surface (CEN).

**S/N Ratio:** Ratio of the measured amplitude of a signal (i.e. a recorded sound) to the amplitude of the background noise.

**Sound Absorption:** Sound absorption by a surface relates to the capacity of the surface not to reflect incident acoustic energy; the part of the acoustic energy which is not reflected is said to be absorbed.

**Sound Absorption Coefficient:** see *Absorption coefficient*

**Sound Intensity:** The sound intensity in a specified direction is the amount of sound energy flowing through a unit area normal to that direction. The sound intensity is normally measured in watt per square metre ( $W/m^2$ ).

**Sound Pressure:** The varying difference, at a fixed point in a given medium, between the pressure caused by a sound wave and either atmospheric pressure or the average pressure of the medium.

**Sound Pressure Level :** The sound pressure level at a point is measured in decibels (dB) and is equal to 20 times the logarithm to the base 10 of the ratio of R.M.S. sound pressure to the reference sound pressure. The reference sound pressure in air is  $2 \times 10^{-5}$  Pa.

**Spatial frequency:** The inverse of wavelength (ISO).

**Stiffness:** The stiffness constant of a spring is the ratio of the (longitudinal) force applied on the spring to the resulting length variation of the spring.

**Stripping:** The loss of binder from the surface of the aggregate in asphalt pavements.

**Surface Dressing:** A surface treatment consisting in the successive laying of at least one layer of binder and at least one layer of chippings (CEN).

**Tack coat:** A thin film of binder, such as bitumen or emulsion, which is sprayed on to improve the adhesion between layers of asphalt.

**Texture:** (1) Surface irregularities of a road pavement with horizontal dimensions ("wavelengths") ranging between 0 and 500 mm. Note: texture is divided into microtexture, macrotexture and megatexture (ISO). (2) Deviation of a pavement surface from a true planar surface, with a texture wavelength less than 0.5 m (ISO).

**Texture profile:** (1) Two-dimensional sample of the pavement surface generated if a sensor, such as the tip of a needle or a laser spot, continuously touches or shines on the pavement surface while it is moved along a line on the surface (ISO). (2) The intersection between the surface of the pavement and the plane which contains both the vertical of the measured pavement and the line of travel of the measuring instrument; when the measuring instrument travels in a curve the line of travel is the tangent to that curve, when travelling in a straight line it is this line (CEN).

**Texture profile level:** Logarithmic transformation of an amplitude representation of a profile curve, the latter expressed as a root mean square value, in accordance with the following formula (ISO):

$$L_{tx,\lambda} \text{ or } L_{TX,\lambda} = 20 \times \log_{10} (a_{\lambda} / a_{ref})$$

where

$L_{tx,I}$  is the texture profile level in one-third-octave bands (in dB re  $10^{-6}$  m)

$L_{TX,I}$  is the texture profile level in octave bands (in dB re  $10^{-6}$  m)

$a_{\lambda}$  is the root mean square value of the surface profile amplitude (in m)

$a_{ref}$  is the reference value =  $10^{-6}$  m

$\lambda$  is the subscript indicating a value obtained with a one-third-octave-band filter entered on wavelength  $\lambda$

**Texture spectrum:** Power spectrum obtained when a profile curve has been analysed by either digital or analogue filtering techniques in order to determine the magnitude of its spectral components at different wavelengths or spatial frequencies (ISO).

**Tolerance:** The range between an upper specification limit and a lower specification limit.

**Unevenness:** (1) Surface irregularities of a road pavement with horizontal dimensions greater than 500 mm and vertical dimensions exceeding the tolerance of the design specifications. Note: unevenness is usually identified in two forms: longitudinal or transverse. The former is associated with riding comfort and the latter with rutting (ISO). (2) Deviation of a pavement surface from a true planar surface with the characteristic dimensions along the surface of 0.5 m to 50 m, corresponding to wavelengths with one-third-octave bands including the range 0.63 m to 50 m of centre wavelengths (ISO, CEN).

**Wavelength:** (1) Quantity describing the horizontal dimension of the amplitude variations of a surface profile (ISO); (2) The (closest) distance between periodically repeated parts of a sinusoidal curve (CEN).

**Wearing Course:** The upper layer of the pavement which is in direct contact with traffic. (PIARC)

**Wheel-track or wheel-path:** The parts of the pavement surface where the majority of vehicle wheel passes are concentrated (CEN).



## Glossary of units and symbols

$\alpha$	Sound absorption coefficient
$\alpha_{i,Average}$	Average third-octave band absorption spectrum over a 100 m trial section selected for labelling, <i>LABEL2<sub>Absorption</sub></i> .
$\alpha_{i,PR,n}$	Third-octave band absorption spectrum from static measurements at each spot position within the 100 m road section selected for <i>COP</i> (dB).
$\alpha_{i,PT,n}$	Third-octave band absorption spectrum from static measurements at each spot position within the 100m trial section selected for labelling (dB).
$\alpha_{max}$	Maximum sound absorption coefficient.
$\Delta_{road,m,v,i}$	Difference in third-octave band power spectrum of tyre/road noise for trial surface compared with the HARMONOISE reference surface (dB).
$\Delta_{traffic\ noise}$	Difference in traffic noise from vehicles travelling on trial surface compared with same traffic on a reference surface (dB).
$\Delta\alpha_i$	<i>Acoustic Labelling:</i> Difference in third-octave band absorption spectrum between average for the whole trial length and the absorption spectra at each spot position.  <i>COP:</i> Difference in third-octave band absorption spectrum between that specified for <i>LABEL2<sub>Absorption</sub></i> and the absorption spectra at each spot position.
$\Delta L_{eT,i}$	<i>Acoustic Labelling:</i> Third-octave band enveloped texture level difference between the average for the whole of the trial length and the enveloped texture measured for a trial segment or spot position (dB).  <i>COP:</i> Third-octave band enveloped texture level difference between that specified for labelling and the enveloped texture measured for a road segment or spot position (dB).
$\Delta L_{T,5mm}$	<i>Acoustic Labelling:</i> Texture level difference in the 5 mm wavelength octave band between the average over the whole of the trial length and the enveloped texture measured for a trial segment or spot position (dB).  <i>COP:</i> Texture level difference in the 5 mm wavelength octave band between the average reported for labelling and the enveloped texture measured for a road segment or spot position (dB).
$?_A$	Air temperature (°C).
$?_{ref}$	Reference air temperature (nominally 20°C).
$?_S$	Surface temperature (°C).

$\lambda$	Wavelength (mm).
$\Omega$	Residual air voids (%).
$a_m$	The intercept of the regression equation correlating maximum pass-by noise levels and the logarithm of speed for vehicle category $m$ .
$a_{m,surface}$	The intercept of the generic regression equation for a particular surface type.
$a_{P,W,m,v,i}$	Intercept regression coefficient correlating sound power levels of propulsion noise component and vehicle speed (dB).
$a_{R,W,m,v,l}$	Intercept regression coefficient correlating sound power levels of tyre/road noise component and the logarithm of vehicle speed (dB).
$b_i$	Coefficients in each third-octave band, $i$ , used in calculating $END_T$
$b_m$	The slope of the regression equation correlating maximum pass-by noise levels and the logarithm of speed for vehicle category $m$ .
$b_{m,surface}$	The slope of the generic regression equation for a particular surface type.
$b_{P,W,m,v,i}$	Slope regression coefficient correlating sound power levels of propulsion noise component and vehicle speed (dB).
$b_{R,W,m,v,l}$	Slope regression coefficient correlating sound power levels of tyre/road noise component and the logarithm of vehicle speed (dB).
$C_i$	Difference between sound power level and maximum pass-by noise levels in each third-octave band for tyre/road source (dB).
$CPXI$	Close-proximity Index (dB).
$CPXI_{Average}$	Average CPXI over whole trial length (dB).
$CPXI_{ST,n}$	CPXI for a 20 m trial segment within a trial length for labelling (dB).
$CPXI_{SR,n}$	Average CPXI for a 100 m road section within the road length for $COP$ (dB).
$D_i$	Difference between sound power level and maximum pass-by noise levels in each third-octave band for propulsion source (dB).
dB	Decibel
dB(A)	A-weighted decibel
$DS_{PT,n}$	Dynamic stiffness at spot location $P_{T,n}$ ( $Nm^{-3}$ ).
$DS_{Average}$	Average dynamic stiffness over trial length ( $Nm^{-3}$ ).

$E$	Young's Modulus which indicates the stiffness of a material e.g. rubber compounds used in tyres ( $\text{Nm}^{-2}$ ).
$END_{\alpha}$	Expected pass-by noise level difference due to a difference in acoustic absorption (dB).
$END_{a,PR,n}$	$END_{\alpha}$ at each spot position along a road length for COP (dB).
$END_{a,PT,n}$	$END_{\alpha}$ at each spot position along a trial section identified for labelling (dB).
$END_T$	Estimated pass-by noise level difference from texture level variations (dB).
$END_{T,PR,n}$	$END_T$ at each spot position along a road length for COP (dB).
$END_{T,PT,n}$	$END_T$ at each spot position along a trial length for labelling (dB).
$END_{T,SR,n}$	$END_T$ for each road section along a road length for COP (dB).
$END_{T,ST,n}$	$END_T$ for each trial segment along a trial length for labelling (dB).
$ENR_{\alpha}$	Expected pass-by Noise level Reduction from acoustic absorption of the road surface (dB).
$ERNL$	Expected Road Noise Level (dB).
Hz	Hertz (cycles per second).
$i$	Defines the centre frequency of an octave or third-octave band (Hz).
$L_A$	A-weighted sound pressure level (dB).
$L_A(t)$	Variation of $L_A$ with time $t$ . (dB).
$L_{Aeq,T}$	A-weighted equivalent sound level in the time period, $T$ (dB).
$L_{Amax}$	A-weighted maximum sound level (dB).
$L_{Amax,m}$	Maximum A-weighted pass-by noise level for vehicle category, $m$ (dB).
$L_{Amax,m,v}$	Maximum A-weighted pass-by noise level for vehicle category, $m$ , travelling at speed, $v$ km/h (dB).
$L_{Amax,m,vref}$	Maximum A-weighted pass-by noise level for vehicle category, $m$ , travelling at a reference speed, $v_{ref}$ km/h (dB).
$L_{Amax,m,vref,i}$	Spectra at maximum A-weighted pass-by noise level for vehicle category, $m$ , travelling at a reference speed, $v_{ref}$ km/h. (dB).
$L_{day}$	A-weighted equivalent sound level for the daytime period (dB).
$L_{den}$	A-weighted equivalent sound level for the combined day, evening, night-time period (dB).

$L_{\text{evening}}$	A-weighted equivalent sound level for the evening period (dB).
$L_{eT,i,\text{Average}}$	Third-octave band texture spectrum level in the $i^{\text{th}}$ band, averaged over the trial length (dB).
$L_{eT,i,PT,n}$	Third-octave band texture spectrum at each spot position along trial length (dB).
$L_{eT,i,ST,n}$	Third-octave band texture spectrum for each 20 m segment along trial length (dB).
$L_{eT,i,PR,n}$	Third-octave band texture spectrum at spot position along road length (dB).
$L_{eT,i,SR,n}$	Third-octave band texture spectrum for road section along road length (dB).
$L_{\text{night}}$	A-weighted equivalent sound level for the night-time period (dB).
$L_{P,W,m,v,i}$	Sound power spectrum of propulsion source for vehicle category, m, travelling at v km/h (dB).
$L_{R,W,m,v,i}$	Sound power spectrum of tyre/road source for vehicle category, m, travelling at v km/h (dB).
$L_{T,5mm,\text{Average}}$	The texture level in the 5 mm octave band wavelength averaged over the whole trial length (dB).
$L_{T,5mm,PT,n}$	The texture level in the 5 mm octave band wavelength at each spot position along the trial length (dB).
$L_{T,5mm,ST,n}$	The texture level in the 5 mm octave band wavelength within each 20 m section along the trial length (dB).
$L_{T,5mm,PR,n}$	The texture level in the 5 mm octave band wavelength at each spot position along the road length (dB).
$L_{T,5mm,SR,n}$	The texture level in the 5 mm octave band wavelength within each 20 m section along the trial length (dB).
<b>LABEL1</b>	Assessment based on SPB and CPX measurement (preferred method).
$LABEL1_{CPX}$	$CPXI_{\text{Average}}$ value from each trial, averaged over all trials (dB).
$LABEL1_{SPB}$	$L_{Amax,m,vref}$ value from each trial, averaged over all trials (dB).
<b>LABEL2</b>	Assessment based on SPB and measurement of intrinsic properties of the surface, i.e. texture and where appropriate absorption and mechanical impedance.
$LABEL2_{SPB}$	$L_{Amax,m,vref}$ from each trial, averaged over all trials (dB).
$LABEL2_{\text{Texture}}$	$L_{eT,i,\text{Average}}$ value from each trial, averaged over all trials (dB).



$LABEL2_{Absorption}$	$\alpha_{i,Average}$ value from each trial, averaged over all trials.
$LABEL2_{Mech. Imp.}$	$DS_{Average}$ value from each trial, averaged over all trials ( $Nm^{-3}$ ).
$m$	Identifies a vehicle category where $m = 1, 2$ or $3$ .
$n$	Identifies location of a specific trial or road segment or spot position.
$N$	<i>Acoustic Labelling</i> : Total number of 20 m trial segments or spot positions. <i>COP</i> : Total number of 200 m road segments or spot positions.
$p$	Sound pressure (Pa).
$p_0$	Sound pressure associated with the threshold of hearing ( $20 \mu Pa$ ).
$p_m$	Percentage of vehicles in a traffic stream for a vehicle category, $m$ , expressed as a fraction of the total vehicle flow.
$P_{T,m}$	Spot position at 10 m intervals within a 100 m section identified for labelling where static measurements are carried for <i>LABEL2</i> .
$P_{T,n}$	Spot position at 10 m intervals along the whole trial length where static texture measurements are carried for <i>LABEL2</i> .
$S_{R,N}$	Specifies a 100 m section along a road length consisting of $N$ sections defined during <i>COP</i> .
$S_{T,N}$	Specifies a 20 m section along a trial length consisting of $N$ sections defined during labelling.
$S_{T,m}$	Specifies a 20 m section within a 100 m section of trial length identified for labelling where $m = 1$ to $5$ .
$S_{PT,n}$	Dynamic stiffness for each spot position, $P_{T,m}$ at 10 m intervals within the 100 m section of a trial length selected for labelling (UNITS?).
<i>SEL</i>	Single Event Level or Sound Exposure Level (dB(A)).
<i>SPBI</i>	Statistical Pass-By Index.
$v$	Vehicle speed (km/h).
$v_{min}$	Minimum vehicle speed for valid estimate of SPB noise level (km/h).
$v_{max}$	Maximum vehicle speed for valid estimate of SPB noise level (km/h).
$v_{ref}$	Vehicle reference speed for valid estimate of SPB noise level (km/h).
$X$	Trial length of a surface to be labelled (m).
$Z$	Road length of a surface for <i>COP</i> (m).



## Glossary of abbreviations and acronyms

AADT	Average Annual Daily Traffic
AC	Asphalt Concrete
AFNOR	Association Française de Normalisation
ARRA	American Asphalt Recycling and Reclaiming Association
BASt	Bundesanstalt für Strassenwesen (Federal Highway Research Institute), Germany
BBTM	Beton Bitumineux Tres Mince (Very Thin Asphalt Concrete)
BBUM	Beton Bitumineux Ultra Mince (Ultra Thin Asphalt Concrete)
BEM	Boundary Element Method
BFC	Braking Force Coefficient
BRRC	Belgian Road Research Centre (Belgium)
CBA	Cost Benefit Analysis
CC	Cement concrete
CEN	Comité Européen de Normalisation (European Committee for Standardisation)
COP	Conformity of Production
CPB	Controlled Pass-By
CPX	Close-proximity
CPXI	Close-proximity Index
CROW	Dutch Information and technology Platform for Infrastructure, Traffic, Transport and Public Space, The Netherlands
DAC	Dense Asphalt Concrete
dGPS	Differential Global Positioning System
DPAC	Double Layer Porous Asphalt
DRI	Danish Road Institute, Road Directorate, Denmark
DTF	Danish Transport Research Institute

DWW	Dienst Weg- en Waterbouwkunde (Road and Hydraulic Engineering Institute), Rikswaterstaat, The Netherlands
EACC	Exposed Aggregate Cement Concrete
EP-GRIP	Proprietary surface finish developed in Austria
EU	European Union
FEHRL	Forum of European National Highway Research Laboratories
GRIPROAD	Proprietary surface binder from Germany
HAPAS	Highway Authorities Product Approval Scheme (United Kingdom)
HARMONOISE	<b>H</b> armonised, <b>A</b> ccurate and <b>R</b> eliable <b>M</b> ethods for the European Directive <b>O</b> n the Assessment and Management of Environmental <b>NOISE</b>
HIPR	Hot in-place recycling
HRA	Hot Rolled Asphalt
INRETS	Institut national de Recherche sur les Transports et leur Sécurité (National Institute For Transport And Safety Research), France
IPG	Innovatieprogramma Geluid (Dutch national noise innovation program)
ISO	International Organisation for Standardisation
ITALGRIP	Proprietary surface developed Italgrip s.r.l., Italy
LCPC	Laboratoire Central des Ponts et Chaussées (Public Works Research Laboratory), France
M+P	Company name: M + P Raadgevende Ingenieurs bv, The Netherlands
MPD	Mean profile depth
OGFC	Open-Graded Friction Course
PA or PAC	Porous Asphalt (Concrete)
PAH	Polynuclear Aromatic Hydrocarbon
PAVETEX	Proprietary surface treatment developed in Japan
PCC	Porous Cement Concrete
PERS	Pro-Elastic Road Surface
PMA	Polymer-Modified Asphalt

---

PMB	Polymer Modified Bitumen or Polymer Modified Binder
PSV	Polished Stone Value
RAP	Reclaimed Asphalt Pavement
RMS	Root Mean Square
SCRIM	Sideway-force Coefficient Routine Investigation Machine
SEL	Sound Exposure Level
SFC	Sideways Force Coefficient
SILVIA	<b>Sil</b> enda <b>Via</b> : Sustainable Road Surfaces for Traffic Noise Control
SKANSKA	Company name: Skanska AB, Sweden
SMA	Stone Mastic Asphalt
SPB	Statistical Pass-By
SPBI	Statistical Pass-By Index
SPL	Sound Pressure Level
STC	Surface treated concrete
TOI	Transportøkonomisk Institutt (Institute of Transport Economics), Norway
TP	Thin layer constructed as a combination layer
TRL	Transport Research Laboratory (UK)
TSF	Thin bituminous surfacing – microsurfacing
TUG	Gdansk University of Technology, Poland
TUW	Technische Universität Wien (Vienna University of Technology), Austria
TWC	Thin Wearing Course
UTHMAL	Ultra Thin Hot Mixture Asphalt Layer
VMA	Voids in Material Aggregate
VOC	Volatile Organic Compounds
VTAC	Very Thin Asphaltic Concrete
VTI	Statens Väg- och Trafikinstitut (National Road and Traffic Research Institute), Sweden

WCF        Water Cement Factor

WHO        World Health Organisation

## Appendix A. Measurement methods

The main body of the Guidance Manual refers to a range of different measurement methods that are used for either direct measurement of the acoustic performance of surface or for measurement of intrinsic characteristics that can be used to indirectly determine acoustic performance. This Appendix, based on the SILVIA Project Report by van Blokland and Roovers [157], provides more detail of these methods, particularly those that are used for the classification system described in Chapter 9 and Appendix C.

Procedures for certifying components of the apparatus used in performing these measurements are described in Appendix B.

### A.1 The Statistical Pass-By (SPB) method

The Statistical Pass-By (SPB) method was developed to assess the road surface influence on road traffic noise and the methodology is defined in ISO 11819-1 [26]. Additional requirements to this Standard were found necessary in the SILVIA project for the labelling procedure described in Chapter 9. They are described in the following section and concern corrections for temperature effects and speed range validity. For details regarding to instrumentation, site selection, measurement procedures including traffic and meteorological conditions, the ISO standard should be consulted.

#### A.1.1 Overview of the method

In Chapter 3 of this manual, it was explained that road traffic noise is the accumulation of noise emissions from all vehicles in the traffic stream and is dependent on several factors including vehicle type and speed. To develop a method of classifying the acoustic properties of road surfaces it is therefore important for comparison purposes to be able to normalise for both vehicle type and speed.

The basic principle of the SPB method, as described in ISO 11819-1 [26], is to measure the maximum A-weighted sound pressure levels,  $L_{Amax,m}$ <sup>13</sup>, of a statistically significant number of individual vehicle pass-bys at a specified road-side location together with the vehicle speeds. Each vehicle is classified into one of three vehicle categories,  $m$ , and are described in the ISO Standard as follows<sup>14</sup>:

- *Vehicle Category 1*: Passenger cars; (Category 1) ;
- *Vehicle Category 2a*: Dual-axle heavy vehicles with more than 4 wheels, including commercial trucks, buses and coaches (Category 2) ;

---

<sup>13</sup> Vehicles are selected such that the maximum sound pressure level recorded during a vehicle pass-by is not significantly disturbed by other vehicles in the traffic stream [26].

<sup>14</sup> The category values in brackets are those adopted in the SILVIA procedures and follows closely that used in the HARMONOISE model.

- *Vehicle Category 2b*: Multi-axle heavy vehicles with more than 2 axles including commercial trucks, buses and coaches (Category 3).

This classification system assumes that vehicles with common physical features correspond to similarities in their sound emission when driven under the same operating conditions.

The recommended number of vehicles selected for measurement from each vehicle category is:

- Vehicle Category 1: 100 vehicles
- Vehicle Category 2: 50 vehicles
- Vehicle Category 3: 50 vehicles

Each individual maximum pass-by noise level together with the vehicle speed is recorded, and a regression line of the maximum A-weighted sound pressure level versus the logarithm of speed is calculated for each vehicle category,  $m$ , using the method of least squares [158].

The general form of the regression line for each vehicle category  $m$ , may be expressed as:

$$\text{Maximum Noise Level, } L_{A \max, m, v} = a_m + b_m \cdot \log_{10}(v) \text{ dB} \quad (\text{A.1})$$

where  $a_m$  and  $b_m$  are the intercept and slope derived from the regression equation for each vehicle category,  $m$ , and  $v$  is the corresponding vehicle speed (km/h).

An alternative method for expressing the regression equation is given by

$$\text{Maximum Noise Level, } L_{A \max, m, v} = L_{A \max, m, v_{ref}} + b_m \cdot \log_{10}(v / v_{ref}) \text{ dB} \quad (\text{A.2})$$

where  $L_{A \max, m, v_{ref}}$  is the maximum noise level for category  $m$  vehicles travelling at a reference speed,  $v_{ref}$  km/h derived from Equation (A.1).

The ISO standard recognises the importance of the influence of both air and surface temperature on pass-by noise levels and advises that maximum noise levels should be corrected to a reference air temperature of 20°C [26]. However, there is no standard method to allow for variation in temperature to be included in the methodology. Until the ISO standard is updated to include a correction for temperature, it is advised that SPB measurements should be carried out when air temperatures are close to 20°C.

Although there have been a number of research programmes designed to investigate the influence of temperature effects on tyre and vehicle noise emissions [10], there are few which have been carried out specifically for use with the SPB method. However, research carried out in the UK and the Netherlands has provided some results.

The correction adopted in the UK is included in the UK Highway Authorities Product Approval Scheme (HAPAS) used for the assessment and certification of thin surfacing



systems for highways [108]. Although it is tentative and based upon on-going research, the following correction may be applied to each individual pass-by noise level prior to calculating the regression equation (A.1) given above:

- *Vehicle Category 1:*

$$\text{Corrected } L_{A \max, 1} = \text{Measured } L_{A \max, 1} + 0.03[0.5(0.7q_s + q_A) - 20] \text{ dB} \quad (\text{A.3})$$

where  $q_A$  and  $q_s$  are the air and surface temperatures taken during each pass-by event.

- *Vehicle Category 2 and 3:* No correction applies.

An alternative correction for temperature is given in the HARMONOISE prediction method but this is strictly to be applied to the sound power level due to the tyre/road noise component. However, as an approximation the following correction for temperature may be applied to the maximum pass-by noise level and is expressed as:

$$\text{Correction} = K (q_{ref} - q_A) \text{ dB} \quad (\text{A.4})$$

where  $q_A$  is the air temperature in °C during the measurement and  $q_{ref}$  is the reference temperature, 20°C.  $K$  is the temperature coefficient.

There are a wide range of temperature coefficients for many different road surfaces. For category 1 vehicles it is normally 0.1 and 0.06 for DAC and SMA surfaces respectively. For category 2 and category 3 vehicles the coefficients to apply are 50% of that of category 1.

A similar approach to that expressed in Equation (A.4) is adopted in the Netherlands where the value of  $K$ , the temperature coefficient, is 0.05 for category 1 vehicles and 0.03 for category 2 and 3 vehicles.

Until there is an ISO standard method for correcting SPB noise levels to take into account variations in temperature, either of the methods described above or alternatively, where Member States have their own methods for correcting SPB noise levels for temperature, then these methods are allowed within the SILVIA method.

Figure A.1 shows a typical plot illustrating the relationship between the temperature corrected maximum pass-by noise level and the logarithm of speed for vehicle category 1 (passenger cars). The equation of the regression line shown in the Figure is calculated and takes the form:

$$\text{Maximum Noise Level, } L_{A \max, 1, v} = 8.04 + 33.5 \log_{10}(v) \text{ dB} \quad (\text{A.5})$$

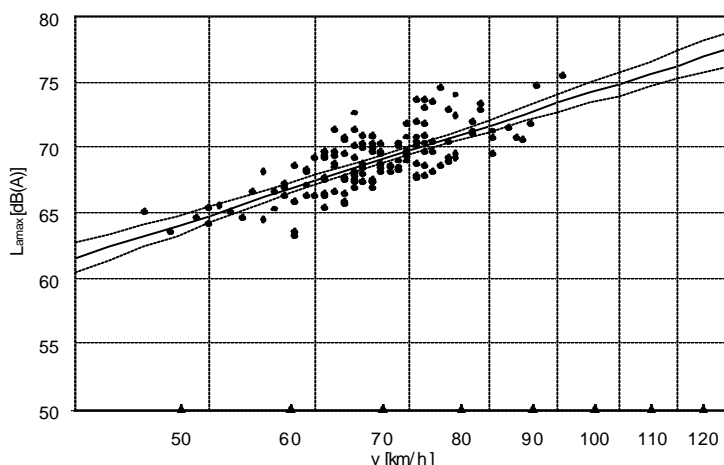

Figure A.1: Scatter diagram of a SPB measurement for passenger cars. The centre drawn line represents the regression function  $a+b.\log(v)$ . The neighbouring curves give the 95% confidence interval of this regression function.

Associated with the regression line are the 95% confidence curves. These curves provide an indication of the error in estimating the true average maximum pass-by noise level at a particular speed. In this example the 95% confidence limits at 70 km/h is 0.3 dB(A) and from the regression equation the maximum vehicle noise level,  $L_{Amax,1,70}$ , is 69.7 dB(A). Therefore, there is a 95% chance that the true average maximum pass-by noise level for category 1 vehicles travelling at 70 km/h on this road surface is  $69.7 \pm 0.3$  dB(A).

Clearly, from Figure A.1, as the speed moves further away from the average value the 95% confidence interval increases, resulting in larger random errors. To minimise the effects of random errors on the accuracy of the results it is necessary to restrict the range of speeds by imposing limits on the 95% confidence interval. For the purposes of classification and COP of road surfaces described in this Guidance Manual the tolerance on the 95% confidence limits shown in Table A.1 will apply for which a valid SPB noise label may be calculated.

Table A.1.: Tolerance on the 95% confidence limits for a valid determination of  $L_{Amax,m,v}$  [26]

Vehicle Category	Tolerance on 95% confidence limits
1	$\pm 0.3$
2	$\pm 0.7$
3	$\pm 0.7$

The valid speed range determined from the tolerances on the 95% confidence limits will be identified and the maximum pass-by noise level at each decade interval e.g. 40, 50, 60 km/h etc, within the valid speed range determined from the regression equation. Using the above example to illustrate this procedure for category 1 vehicles, Table A.2 shows the

values of  $L_{Amax,1,v}$  derived from the regression equation at each decade interval,  $v$ , together with the corresponding values of the 95% confidence interval.

The results from the regression analysis shown in the Table indicate that the valid speeds identified for the purposes of noise labelling are at 60 and 70 km/h.

Table A.2. Tolerance on the 95% confidence limits for a valid determination of  $L_{Amax,1,v}$

Results derived from regression analysis at each 10 km/h interval		
Speed ( $v$ km/h)	Maximum noise level $L_{Amax,1,v}$ dB(A)	95% confidence interval dB(A)
40	61.6	1.1
50	64.8	0.7
<b>60</b>	<b>67.5</b>	<b>0.3</b>
<b>70</b>	<b>69.7</b>	<b>0.3</b>
80	71.6	0.5
90	73.4	0.7
100	74.9	0.9

In this example, the analysis of the SPB data for category 1 vehicles has provided valid noise level values,  $L_{Amax,1,vref}$ , of 67.5 and 69.7 dB(A) at reference speeds,  $v_{ref}$ , 60 km/h and 70 km/h, respectively.

Similar analysis of the SPB data for the other vehicle categories 2 and 3 would need to be carried out to obtain valid noise levels for labelling for these vehicle categories, if required.

The procedure for calculating the **SPB noise labels**,  $LABEL1_{SPB}$  and  $LABEL2_{SPB}$ , for the SILVIA surface classification procedure is described in the next section.

### A.1.2 Procedure for determining SILVIA SPB noise values used for labelling

In Chapter 9 of the Manual, two possible labelling procedures are described, LABEL1 and LABEL2. Both procedures use results from SPB measurements to provided valid noise level values,  $L_{Amax,m,vref}$ , as described in the previous section.

To derive the SPB noise label values  $LABEL1_{SPB}$  and  $LABEL2_{SPB}$  respectively, requires a sufficient number of valid SPB noise level values,  $L_{Amax,m,vref}$ , to be averaged from different work locations. The aim is to reduce the influence of different aggregate types and variations in the laying process on the SPB noise label values.

As a minimum, it is required to average at least two values of valid noise level values,  $L_{Amax,m,vref}$ , for each vehicle category,  $m$ , at a reference speed,  $v_{ref}$  km/h, to obtain the appropriate SPB noise label values  $LABEL1_{SPB}$  or  $LABEL2_{SPB}$ .

The following example illustrates the procedure for deriving the SPB noise label values. Table A.3, shows the results from SPB measurements carried out alongside three different work locations (trial lengths) where the trial surface has been used.

Table A.3.: Example showing results from SPB measurements for each vehicle category carried out at three locations and the determination of noise label values LABEL1<sub>SPB</sub> or LABEL2<sub>SPB</sub>

Speed, $v_{ref}$ (km/h)	Valid SPB noise levels, $L_{Amax,m,vref}$ dB, for each trial length and vehicle category, m									LABEL1 <sub>SPB</sub> or LABEL2 <sub>SPB</sub>		
	Trial Length 1			Trial Length 2			Trial Length 3					
	1	2	3	1	2	3	1	2	3	1	2	3
40		68.0										71.0
50		70.1	73.0									
60	67.5	72.0			72.6	75.6	67.3				67.4	72.3
70	69.7			69.3			69.5	75.5			69.5	
80				70.5								
90												

For each trial, the valid SPB noise levels  $L_{Amax,m,vref}$ , for each vehicle category,  $m$ , are shown at the corresponding reference speed,  $v_{ref}$ . The final column in the Table shows the noise label values, LABEL1<sub>SPB</sub> or LABEL2<sub>SPB</sub> which are determined by averaging at least two SPB noise levels for each vehicle category at the same reference speed. In this example, there is sufficient data from the three trials to provide noise label values for category 1 vehicles at 60 and 70 km/h of 67.4 and 69.5 dB(A) respectively and for category 2 vehicles at 60 km/h of 72.3 dB(A). Although each trial provided valid SPB noise levels for category 3 vehicles the associated reference speeds were all different and therefore did not meet the criteria that at least two SPB noise levels at the same reference speed are required for labelling.

Within each vehicle category, the speed range of vehicles selected from the traffic for SPB measurement will vary from each trial. As a general rule, the range of speeds for which the tolerances on the 95% confidence interval, shown in Table A.1 will be met, lie within ±1 standard deviation from the actually measured average speed for category 2 and 3 vehicles and ±1.5 standard deviation for category 1 vehicles. By careful selection of vehicles, valid SPB noise levels at a particular reference speed may be obtained by controlling the average speed of the sample. Such considerations may help to avoid the situation illustrated above where the reference speeds for the valid SPB noise levels for category 3 vehicles were all at different speeds.

The above procedure describes the method for determining noise level values for LABEL1<sub>SPB</sub> or LABEL2<sub>SPB</sub>. Each value is defined for a specific vehicle category,  $m$ , at a given reference speed,  $v_{ref}$  km/h. However, it may be required to determine label values over a wide speed range when, for example, a surface type is to be used on both low and high speed roads. To extend the range of application, the SILVIA method for SPB noise labelling allows values to be calculated from a regression analysis based on at least five

SPB noise levels for each vehicle category where two values are calculated at a low reference speed, two at the higher reference speed and one at an intermediary speed.

The following example illustrates the method. Figure A.2 shows the results from 5 trial locations where SPB measurements of category 1 vehicles provided two valid noise values at a low reference speed of 40 km/h, two at a high speed reference speed at 110 km/h and an intermediary value at 70 km/h.

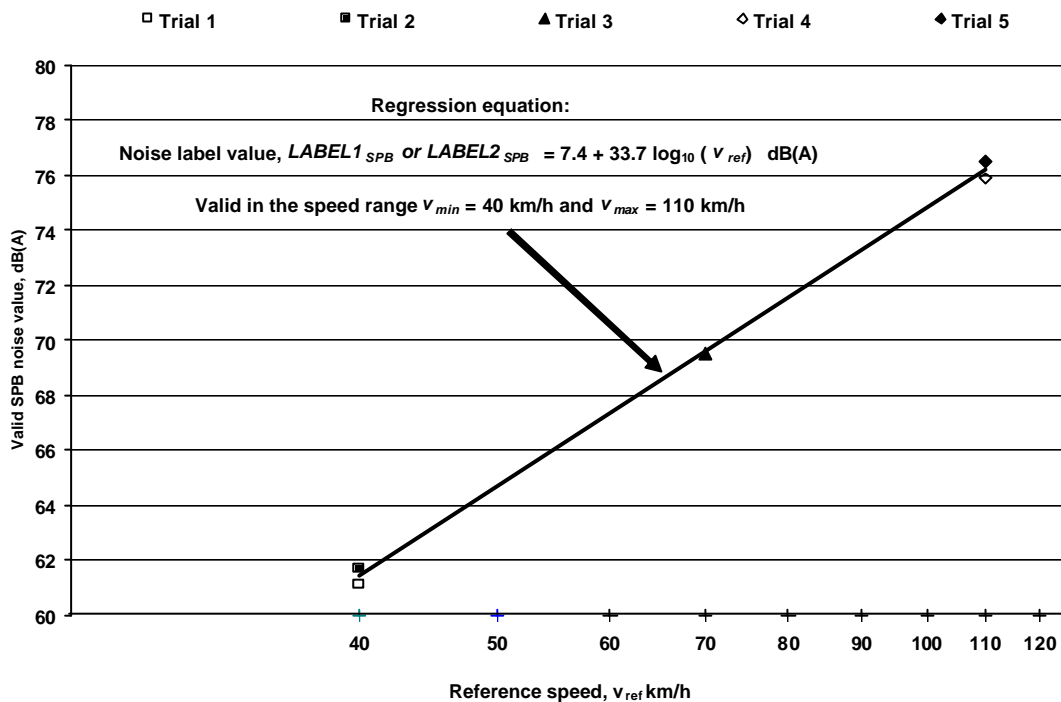

Figure A.2: Scatter diagram of valid SPB noise levels for category 1 vehicles. The regression equation represents the generic expression for determining noise label values,  $LABEL1_{SPB}$  or  $LABEL2_{SPB}$  within the specified speed range.

A linear regression analysis of the data provides the following generic expression to determine noise label values:

$$LABEL1_{SPB} \text{ or } LABEL2_{SPB} = a_{m,surface} + b_{m,surface} \cdot \log_{10} (v_{ref}) \text{ dB} \quad (\text{A.6})$$

Using this equation enables SPB noise label values for both  $LABEL1_{SPB}$  or  $LABEL2_{SPB}$  to be calculated at any reference speed within the regressed speed range:  $v_{min} = 40$  km/h and  $v_{max} = 110$  km/h. Although it is possible to reduce the number of trials to only 4 locations in order to produce a generic expression of the type given in Equation (A.6) i.e. providing two values at each end of the speed range, it is recommended that an intermediary value is measured to check the reliability of the regression equation.

The above procedures have described the method for determining label noise levels for road surfaces used in the SILVIA classification system. Further application of the data used in deriving label values may be used for other purposes such as those described in

Appendix D. An important application is in providing input data to the HARMONOISE prediction method which requires third-octave band power spectral information of both the propulsion and tyre/road noise components of a vehicle.

In addition, under the LABEL2 procedures which rely on measurements of certain intrinsic properties of the surface, it is required that the third-octave band spectra for category 1 vehicles is used as input.

The following section describes the SILVIA method for obtaining average octave and third-octave band spectra from SPB measurements.

### A.1.3 SPB spectral information

Although for the purposes of labelling, only valid noise level values,  $L_{Amax,1,vref}$ , are required, spectral information should also be supplied. Several European prediction models require, as input, octave or third-octave spectra for each vehicle category at a reference speed to enable overall traffic noise levels to be estimated. As part of the SILVIA reporting process, described in Section A.1.4, an average spectrum for each vehicle category should be supplied. As previously mentioned, this information can also be used as input to the HARMONOISE prediction method as described in Appendix D.

The procedure for obtaining SPB spectral information is set out below. The initial procedure describes the method to be adopted at a single trial location, further refinements to the method are described later.

To illustrate this procedure the SPB data shown in Figure A.1 will be used. The results of the regression analysis shown in Table A.2 indicate that the speed range for valid estimates of the maximum pass-by noise level lies between 60 to 70 km/h. The average spectrum is determined by linearly averaging the measured octave band spectral level,  $L_{Amax,m,v,i}$ , in each octave band,  $i$ , at the maximum pass-by noise level,  $L_{Amax,m,v}$ , of only those vehicle passages within the valid speed range. Before averaging, the measured spectra are normalized to an overall value of 0 dB(A). No further speed correction is applied. The resulting average spectrum is in effect also normalized to 0 dB(A). This process is illustrated in Table A.4 and the resultant shape of the normalised spectra is shown in Figure A.3.

The shape of the average normalised octave band spectra is assumed to be independent of speed within the valid speed range for determining SPB noise levels. In the above example shown in Figure A.1, the average normalised octave band spectra shown in Figure A.3 can be used together with the regression equation, Equation A.5, to obtain the absolute spectral levels at the two reference speeds, 60 and 70 km/h. This analysis is shown in the following Table A.5.

Where a series of SPB measurements at five different trial locations have been carried out as described in the previous section, see Figure A.2, a generic form of the normalised octave band spectra may be derived by averaging the individual normalised spectra from each trial. Using the generic regression equation, shown in the Figure, together with the averaged normalised spectra from each trial, the octave spectra at any speed within the valid speed range, 40 to 110 km/h can be derived in a similar manner as that shown in Table A.5.

Table A.4.: Example showing procedure for determining average normalised spectra

Octave Band Centre Frequency (Hz)	Single vehicle event			Average normalised spectra over all $n$ events $\frac{\sum S}{n}$ (dB)
	Maximum pass-by noise level, $L_{Amax,m,v}$ (dB)	Measured Spectra (dB)	Normalised spectra, $S$ (Measured spectra - Maximum noise) (dB)	
63	70	45	-25.0	-25.3
125	70	47	-23.0	-22.7
250	70	52.3	-17.7	-18.6
500	70	61.2	-8.8	-7.8
1k	70	68.1	-1.9	-1.8
2k	70	62.2	-7.8	-9.5
4k	70	54.7	-15.3	-16.5
8k	70	43	-27.0	-23.2

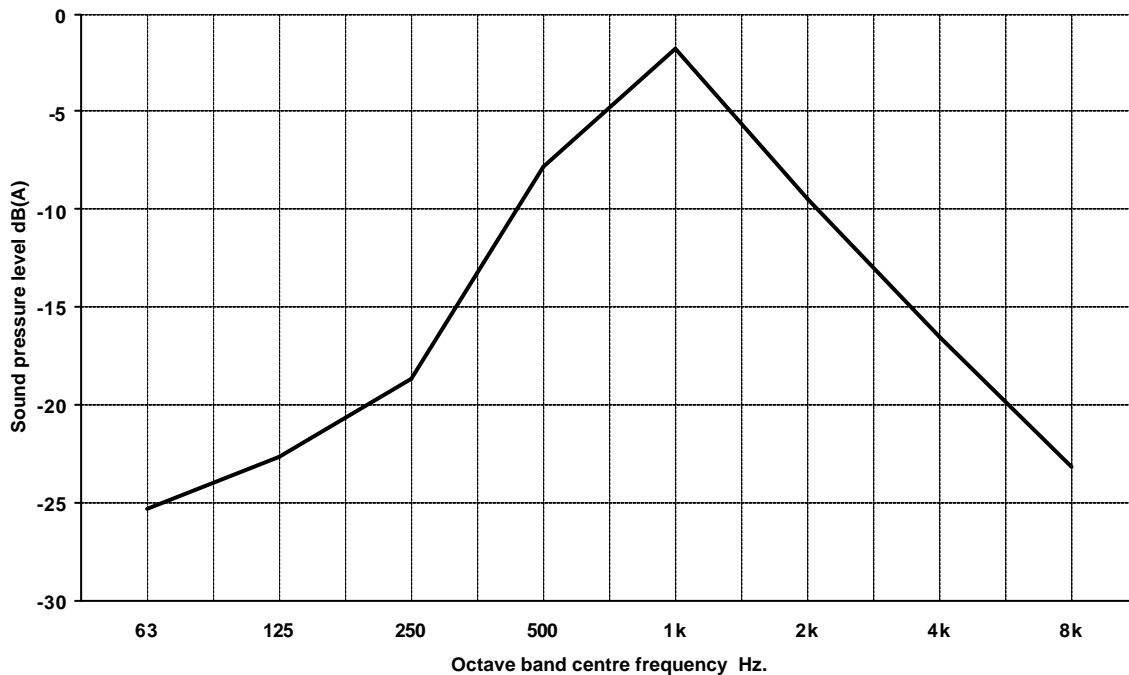

Figure A.3: Average normalised octave band spectra derived from results of SPB measurements within the valid speed range 60 to 70 km/h, shown in Figure A.1

Table A.5.: Example showing procedure for determining spectra at nominated reference speed

Octave Band Centre Frequency  Hz	Average normalised spectra  dB	Maximum noise level at reference speed		Octave band spectral levels at reference speed	
		dB		dB	
		60 km/h	70 km/h	60 km/h	70 km/h
63	-25.3	67.4	69.7	42.1	44.4
125	-22.7	67.4	69.7	44.7	47
250	-18.6	67.4	69.7	48.8	51.1
500	-7.8	67.4	69.7	59.6	61.9
1k	-1.8	67.4	69.7	65.6	67.9
2k	-9.5	67.4	69.7	57.9	60.2
4k	-16.5	67.4	69.7	50.9	53.2
8k	-23.2	67.4	69.7	44.2	46.5

The method described above has been shown to be reliable for octave band spectra. For some applications as discussed earlier, spectra derived from SPB measurements are required to be expressed in terms of third-octave band levels. Under such circumstances, third-octave band levels should be derived by interpolation using measured octave band spectra as illustrated in the next section.

#### **Converting to third-octave band levels:**

To illustrate this procedure the octave band spectra shown in Table A.5 at the nominated reference speed of 70 km/h will be used to estimate the appropriate third-octave band levels. The procedure for conversion is shown in Table A.6.

The second column of Table A.6 shows the octave band levels that require converting to third-octave band levels. The first step is to linearly interpolate the third-octave band levels from the octave band levels as shown in the third column of Table A.6. The overall level of the interpolated spectra is shown to be 4 dB(A) higher than the original spectra and therefore the third-octave band levels need to be normalised accordingly, as shown in the final column of the Table.



Table A.6.: Example showing procedure for converting octave band spectra to third-octave band spectra

Third-octave band centre frequency	Octave band levels	Interpolated third-octave band levels	Normalising for difference in overall levels	Estimated third- octave band levels
Hz	dB(A)	dB(A)	dB(A)	dB(A)
63	44.4	44.4	4	40.4
80		45.3	4	41.3
100		46.1	4	42.1
125	47	47.0	4	43.0
160		48.4	4	44.4
200		49.7	4	45.7
250	51.1	51.1	4	47.1
315		54.7	4	50.7
400		58.3	4	54.3
500	61.9	61.9	4	57.9
630		63.9	4	59.9
800		65.9	4	61.9
1k	67.9	67.9	4	63.9
1.25k		65.3	4	61.3
1.6k		62.8	4	58.8
2k	60.2	60.2	4	56.2
2.5k		57.9	4	53.9
3.2k		55.5	4	51.5
4k	53.2	53.2	4	49.2
5k		51.0	4	47.0
6.3k		48.7	4	44.7
8k	46.5	46.5	4	42.5
<b>Overall Level dB(A)</b>	69.6	73.6		69.6

Figure A.4 shows the octave band spectra together with the estimated third-octave band spectra derived in Table A.6. Clearly, without more detailed information regarding the distribution of energy within each octave band, the shapes of the two spectra are similar and therefore, the resulting third-octave spectra can only be regarded as an approximation.

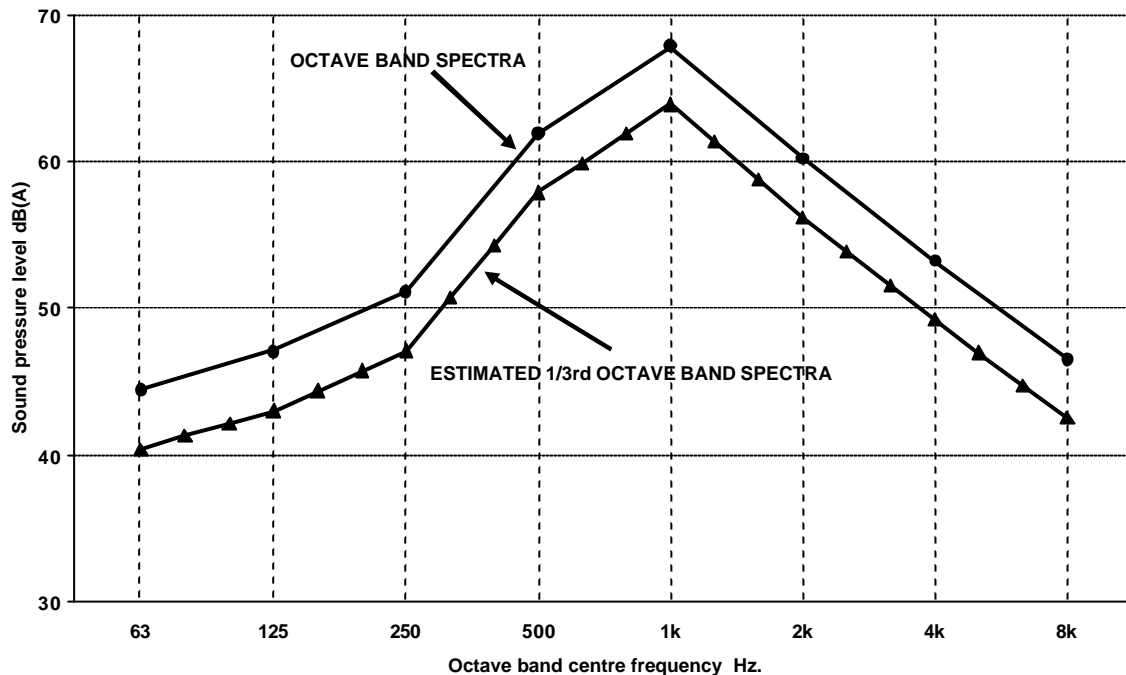

Figure A.4.: Estimated third-octave spectra derived from octave band spectra using the procedure described in Table A.6.

Where a series of SPB measurements at five different trial locations have been carried out as described in the previous section, see Figure A.2, and a generic form of the normalised octave band spectra has been derived, as discussed earlier, the third-octave band spectra can be determined. Using the generic regression equation, shown in the Figure, together with the averaged normalised spectra from each trial the octave spectra at any speed within the valid speed range, 40 to 110 km/h can be derived in a similar manner as that shown in Table A.5. Using the procedure described above the octave band spectra can then be converted to third-octave band levels.

#### A.1.4 Information to be reported for labelling

The following section provides advice on the information which should be included when reporting label SPB noise levels,  $LABEL1_{SPB}$  or  $LABEL2_{SPB}$  and associated spectra.

The reported data from each SPB measurement carried out at each trial location should conform to the corresponding requirements given in the ISO standard (ISO, 1997). Briefly these are listed as follows:

- *General information (Date of measurement and equipment certification);*
- *Location and general appearance of test site;*
- *Road surface detail (Age, type, maximum chipping size, void content etc);*
- *Environmental factors (Average air and surface temperature etc);*

- *Details of vehicles (Category, number of samples);*
- *Results from regression analysis for each vehicle category, to include:*
  - *The temperature corrected regression equation;*
  - *The temperature correction applied to the data;*
  - *The maximum and minimum speed for a valid estimate of SPB noise levels using the regression equation;*
  - *The individual SPB noise levels at each decade of speed i.e. 50-60-70 etc. over the valid speed range, expressed to the nearest 0.1 dB(A);*
  - *The normalised average octave band spectra;*
  - *For LABEL2 classification include the third-octave band spectra for category 1 vehicles.*

For the purposes of labelling, the information as described above, will be required from at least two trial locations where the reference speeds are the same. In addition, the following information should be supplied:

- *The maximum noise level at each reference speed,  $L_{Amax,m,ref}$ , used in calculating label noise levels LABEL1<sub>SPB</sub> or LABEL2<sub>SPB</sub>;*
- *The LABEL1<sub>SPB</sub> or LABEL2<sub>SPB</sub> values derived from the average noise levels,  $L_{Amax,m,ref}$ , expressed to the nearest 0.1 dB(A);*
- *For LABEL2<sub>SPB</sub> values, the corresponding average third-octave band spectra for category 1 vehicles at each reference speed.*

Where sufficient data has been collected to derive a generic regression equation i.e. from at least five trial locations the following information should be included for each vehicle category,  $m$ :

The generic regression equation in the form:

$$LABEL1_{SPB} \text{ or } LABEL2_{SPB} = a_{m,surface} + b_{m,surface} \cdot \log_{10}(v_{ref}) \text{ dB};$$

- *The maximum and minimum speed for a valid estimate of LABEL1<sub>SPB</sub> or LABEL2<sub>SPB</sub> noise levels using the generic regression equation;*
- *The generic normalised averaged octave band spectra.*

### **A.1.5 Representativity**

Results from an SPB measurement i.e. the maximum pass-by noise level from a vehicle measured at the roadside, is assumed to be highly correlated with the total noise

exposure received outside residential properties and other noise sensitive locations situated some distance away from the road. The following sections discuss this relationship, in particular, to what extent do:

- To what extent do maximum noise levels,  $L_{Amax}$ , represent noise exposure levels,  $L_{Aeq}$ , at the measurement position?
- What is the influence of noise propagation on received noise levels at some distance from the road?

### Step 1: $L_{Amax}/L_{Aeq}$ relationship at the measurement position

During the development of the SPB ISO-standard the relationship between  $L_{Amax}$  and  $L_{Aeq}$  levels was studied. It was found that for passenger cars, there was good correlation between the two quantities after correcting for the speed dependence term,  $10\log(v)$ . The estimated standard error was 0.5 dB, half of which can be explained by the uncertainty in the measurement method.

These results are corroborated with the results of the Sperenberg project [159], shown in Figure A.5. The Figure shows the correlation for each third-octave band centre frequency, 125 to 5k Hz, between  $L_{Amax}$  (corrected for speed,  $10\log(v)$ ) and SEL levels. The Figure shows the degree of correlation in terms of the regression coefficient for the case of rolling noise of passenger car tyres measured on SMA0/8 and DAC 0/8 according to ISO 10844.

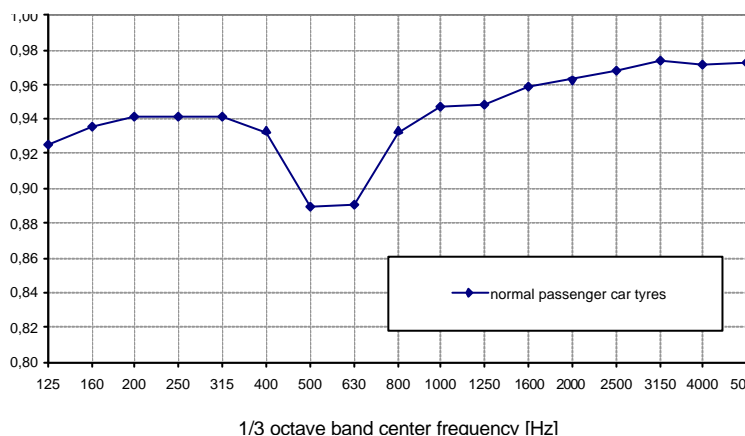

Figure A.5: Correlation values of the regression analysis of the linear relation between SEL and  $(L_{Amax} - 10 \log(v))$  Results for passenger car CPB measurements on Sperenberg [159]

The slightly lower values of the correlation around 500 to 630 Hz can be explained by propagation effects due to differences in the position of the vehicle when measurements are taken; for  $L_{Amax}$ , noise levels are captured when the vehicle is generally positioned adjacent to the microphone whereas, for SEL<sup>15</sup> measurements propagation occurs over a wider range of distances throughout the vehicle pass-by event. However, over the indicated frequency range, the relationship is highly correlated with maximum noise levels,

<sup>15</sup> SEL is the sound exposure level and is the equivalent noise level,  $L_{Aeq}$  measured over a period of one second.

$L_{Amax}$ , providing a good representation of noise exposure levels,  $L_{Aeq}$ , at the measurement position.

### **Step 2: Relationship between 7.5 m position to further distances**

Propagation effects that occur as noise travels away from the road can have a significant influence on the acoustic performance of the road surface.

The propagation of sound from the source to the receiver exhibits frequency dependent processes such as ground effect (interference between direct and reflected path) that leads to strong attenuation effects at specific frequencies in the sound spectrum, diffraction effects by barriers that in general are stronger for high frequencies than for low frequencies, and air absorption that suppresses the propagation of high frequencies over longer distances. In the case of frequency dependent SPB results, a propagation model (like the ones developed in HARMONOISE) takes such spectral propagation effects into account, leading to a good prediction at the far field. These expectations are supported by a study of LCPC [160].

Care should also be taken during the SPB measurement concerning the intervening ground cover between the microphone and the vehicle. The effects observed at the SPB measurement position can deviate from the effects found at larger distances [161]. It is important that sites selected for measurement conform to that described in the ISO standard [26].

## **A.1.6 Repeatability and reproducibility**

Selecting the SPB procedure as a favourable procedure for road surface classification requires a high level of reproducibility and repeatability. An extensive study on this subject was performed by LCPC in which they studied the statistical variance within and between laboratories [162, 163].

The reported values for the spread (defined as the square root of the variance) within laboratories was 0.3 dB for light vehicles and 0.5 dB for heavy vehicles, leading to an estimated repeatability of 0.8 dB for light vehicles and 1.3 dB for heavy vehicles (80% coverage factor). The reproducibility (that also comprises the spread between laboratories) was found to be 1.1 dB for light vehicles and 1.8 dB for heavy vehicles.

It can be concluded that the main cause of uncertainty lies within the procedure itself and not so much on the operator.

Within the scope of the SILVIA project the SPB method has been studied further and the following observations made:

- *The repeatability and reproducibility of the SPB method* was tested by performing two SPB measurements taken at the same location using different teams and apparatus. This study led to the following findings:
  - *Repeatability*: differences found within a team are 0.2 to 0.4 dB (peak-peak) for different vehicle classes;
  - *Reproducibility*: 0.4 to 0.6 dB (peak-peak) differences found between the teams

These results corroborate the findings of LCPC.

- With regard to tests carried out *investigating the influence of ground cover and measurement height*, although earlier measurements demonstrated that a higher microphone position is less sensitive to impedance changes to the intervening ground cover between the microphone and the vehicle, no clear conclusions could be drawn from the current tests;
- For tests investigating the classification of vehicles, within the population of heavy vehicles (the number of axles being 3 or larger) comprising different axle configurations, a subset was identified consisting of a very common axle configuration, namely a 2-axle tractor/3-axle trailer (2T3T) combination. The results found for the total population when compared with those found for the 2T3T, led to the following conclusions:
  - That the average levels for the two populations were the same;
  - That the residual error (after regression) was about 30% larger for the total population;
  - That the 95% confidence intervals were similar.

Thus a narrower subset does exhibit less spread as expected, however the average values were about the same (can be understood from the large contribution of the driving axle), but due to the smaller number of vehicles in the more narrow vehicle class, the smaller spread does not lead to a more accurate value for the average.

### A.1.7 Standardisation

The general acceptance of the SPB procedure has been acknowledged by the national standard institutes organized within ISO and has led to the development of an international standard [26]. This standard has received world-wide acceptance and is the basis of many national studies and acoustical classification schemes for road surfaces.

The experience in applying the method over the last 15 years has highlighted a need for updating some parts of the standard. A new work item proposal on this topic was accepted by ISO and the task was given to TC43/WG 33.

The WG will address such items as the microphone position, microphone height, requirements on propagation and controlling reflection effects particularly in urban areas, data processing and vehicle classification.

The main objective of this revision is to broaden the application area and to improve representativity and reproducibility. It is expected that within 3 years a revised version of the ISO 11819-1 will be available.

### A.1.8 Conclusions

It can be concluded that the SPB method is a representative and reliable method for standardizing vehicle noise levels for a given vehicle category on a certain road surface

under defined driving conditions and environmental conditions. By comparing SPB levels assessed on different road surfaces the influence of the surface on vehicle noise emissions can be established.

It is the general opinion of the partners in WP 2 that the Statistical Pass-By method is the basic measurement method to be used for road surface classification and that the method for determining noise levels for the purposes of labelling are as described in the above sections.

## A.2 The Close-Proximity (CPX) method

### A.2.1 General description of the method

The Close Proximity (CPX) method described in ISO 11819-2 [113] is designed to assess the acoustic properties of road surfaces by measuring the rolling noise of a set of standard tyres at two microphone positions located close to the tyre/road contact patch.

The method consists of taking measurements with a set of 4 standard tyres (i.e. Avon ZV1 185/65R15, Avon Enviro CR322 185/65R15, Avon Turbogrip CR65 185/65R15 and Dunlop AP Arctic 185R14, simply referred to as tyre A, B, C and D respectively) Examples of the standard tyres used for CPX measurements are shown in Figure A.6.



Figure A.6: Standard tyre set for performing CPX measurements

The measurements are taken at two microphones mounted at 20 cm from the tyre side wall 20 cm in front and behind the centre of the contact patch and 10 cm above the road surface. During the measurements the tyres are allowed to roll freely at a constant speed over the road surface and the noise level at the microphones positions are sampled using suitable instrumentation. The recorded noise levels are averaged over 20 m sections and over the two microphones.

The average levels determined for tyres A, B, C and D has been found to be representative for the effect of the road surface for cars, the level of only tyre D, which has

a coarser tread pattern, was found to correlate reasonably well with the surface effect for trucks [164].

To obtain reliable results averaging shall be performed over at least 200 m length of the surface, either as two repetitions of a 100 m section or as ten repetitions of a 20 m section.

The test tyres can either be mounted on a trailer, which can be towed over the test surface, or can be incorporated in a specially designed vehicle. Ideally, the trailer or vehicle system has to meet the requirement that the influence of both background noise and the construction of the vehicle shall not influence the noise level found at the microphone positions by more than 1 dB. Correction factors have been derived to deal with effects related to the design of the vehicle that affect the measurement results by up to a maximum of 3 dB.

This method can be regarded as being complimentary to the SPB method. The SPB method gives a high quality result, including all relevant noise sources of the vehicle fleet and all relevant vehicle classes. Its result however is limited to a relatively small section of the road surface located opposite to the measurement microphone. Importantly, accurate measurements can only be obtained where the traffic flow is conducive to this type of measurement and the surroundings are free from obstacles and reflecting surfaces. Consequently, the SPB method can have only a limited application in real road situations.

The CPX method is much less sensitive to the environmental conditions, can operate in situations with no traffic up to situations with dense traffic (although with stable driving speeds) and can produce relevant data over the entire length of the road surface being investigated.

The properties of the CPX method make it a favourable system for determining the COP (Conformity of Production) of a road surface. The SPB method is the preferred method for road surface classification applications.

### **A.2.2 The SPB/CPX relationship**

A study was performed as part of the SILVIA project on SPB and CPX data measured on the same road surface (see [165]). The data was obtained from 6 different sources and covered several CPX-systems, widely varying road surfaces, both light and heavy vehicles and speeds between 50 and 110 km/h.

Each set of data was analyzed with a linear regression between the CPX and SPB levels. The residual standard deviations found after the regression analysis were between 0.5 dB and 1.7 dB.

The average difference found between the SPB level for light vehicles and the related CPX level at the same speed was 21.2 dB with a spread of about 0.8 dB. This is consistent with a theoretical approach performed within the SILVIA project, based on models of sound propagation, that predicts a 22 dB(A) difference for dense road surfaces and a slightly higher difference in the case of porous road surfaces [166, 167].

It was noted that the slope of the regression line differed significantly from 1.0 and ranged between 0.8 and 1.2. No clear relation between the slope and any other relevant parameter was found. The cause and nature of this scatter is not well understood.



The CPX method cannot therefore replace the SPB method for the acoustical classification of road surfaces, since it lacks a clear unambiguous relation with the sound emission of vehicles on different road surfaces.

### **A.2.3 Representativity**

The representativity of the CPX method for absolute SPB results is considered to be limited since:

- The CPX system only relates to rolling noise effects and neglects propulsion noise effects;
- It cannot reproduce the mechanical characteristics of truck tyres (although the tyre D for many road surfaces shows a remarkable good representativity for these types of tyres);
- It measures in the near-field of the noise source (and therefore may also include the non-radiating parts in the sound field). Also the propagation effects of absorbing road surfaces affect the close proximity microphone positions differently to the SPB microphone position;
- It measures at two distinct positions while the SPB is the result of an averaging over several radiation directions of the tyres.

These factors are possibly the cause of the poor SPB-CPX relationships found by Roovers and Peeters [165] (see Section A.2.2) but a clear explanation leading the variance back to these factors was not successful.

The general ability to predict SPB levels for cars from CPX, without taking into account the type of surface and of measuring system will exhibit an accuracy of about  $\pm 2$  dB. For heavy duty vehicles, the error is expected to be larger. It can be concluded that such an inaccuracy is inadequate for prediction and classification purposes.

### **A.2.4 Repeatability and reproducibility**

The repeatability and reproducibility of the CPX method was studied in two large scale studies, one performed in 1997-98 [164] and one performed as part of the SILVIA project [185, 168].

Results were taken using five measurement systems and the 24 road surfaces examined in the SILVIA study. The spread in the results, expressed in the CPX-index, found for the same road surfaces is about 0.2 to 0.3 dB and the observed average maximal difference is about 1.0 dB. These results are similar to results found in the 1997-98 study (see Figure A.7) and corroborate the acceptable repeatability of the method.

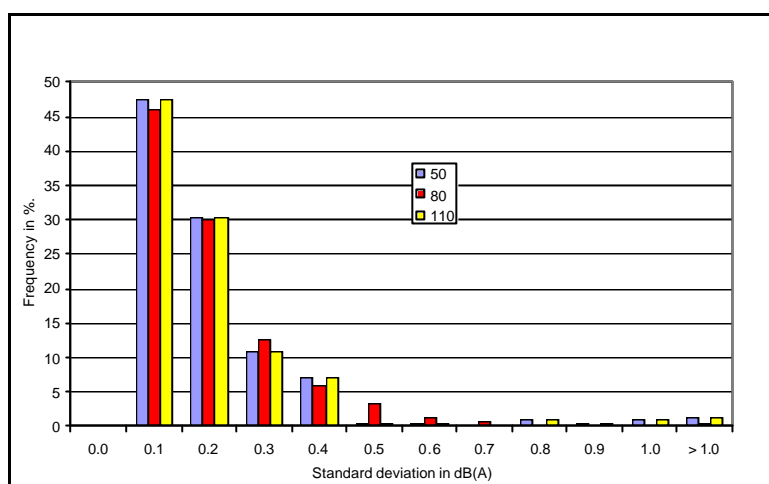

Figure A.7: Comparison of repeatability at 50, 80 and 110 km/h. Given is the percentage of CPX measurements in which the standard deviation of repeated runs is within the given value (0.1 means between 0.0 and 0.1). Data from international CPX validation test [164]

The reproducibility was originally studied in the international CPX validation test [164] and was found to be limited, mainly due to the allowed freedom in microphone positions, even after correcting for this (and other) effects. The results exhibit a scatter of up to 6 dB. This finding has led to a significant improvement of the specification of the measuring systems, allowing a limited disturbing effect on the signal to be measured and allowing only one microphone position.

These changes to the specification have resulted in an improvement in the reproducibility in general, although the reproducibility for a microphone position class (be it outer or inner) has remained the same. This is probably related to differences in the condition of the test tyres used. Changes in the tyre hardness due to ageing, use and storage conditions can affect the noise levels. Figure A8 presents the standard deviation in the results for the different road surfaces studied.

In the SILVIA Round-Robin Test [185, 168] since one system employed non-standard tyres, reproducibility was studied using four different measurement systems. The standard deviation in the results, again expressed in CPX-index, found at the same road surface with different systems ranged between 0.3 and 1.3 dB and was on average 0.6-0.7 dB. The largest difference found was 2.9 dB, which is in line with the assumption that the peak value is about 4 times the standard error. These results are comparable with results found in the 1997-98 study.

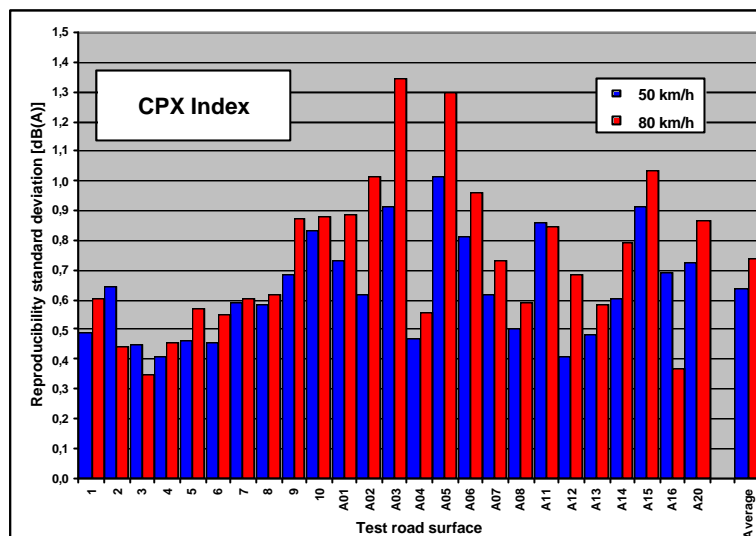

Figure A8: Standard deviation in results (expressed as CPX-index) found at the same road surfaces at speeds of 50 and 80 km/h [185]

Recent comparison of the standard tyres, performed under controlled conditions on a drum, indicated that that differences of up to 2 dB may occur. Although only a small set of tyres was investigated, these results indicate that about half of the reproducibility can be explained by the spread in tyre properties. It was not possible to determine the effects on reproducibility that could be attributed to differences in the measurement systems [169, 170].

### A.2.5 Standardisation of the method

The CPX method is at present being developed into an international standard by ISO TC43/WG33. Although the method is already widely used, the finalization of the standard has been delayed by difficulties in standardizing the test tyres. At time of writing, the method is separated into two parts, one describing the measurement procedure and data processing and one part referencing the tyres. It is anticipated that the first part will, be proposed for standardisation following publication of the SILVIA manual.

The development of the second part is in its primary phase. The standardization of tyre D is seen as a particularly difficult problem to solve.

In addition, there are problems associated with the availability of reference tyres A, C and D. However, recent work carried out by TRL has shown that good correlation between CPX and SPB levels for both category 1 and category 3 vehicles can be attained using reference tyre B which is still available. This work also showed that by averaging noise levels measured in front of and behind the tyre, in line with the direction of travel, improved correlations were obtained when the data included results from porous surfaces compared with results obtained using the mandatory microphone positions [171].

## A.2.6 Monitoring using CPX: Experiences with the GeoCPX-method

The acoustical quality of road surfaces is an important criterion in assessing the physical state of the road network. The application of low-noise road surfaces, as well as any maintenance to ensure the acoustical quality of the road surface, contributes significantly to the quality of life in residential areas.

M+P have developed a method, known as GeoCPX, for monitoring the acoustical quality of a road network. The main output from GeoCPX are noise maps showing the acoustical performance of the road surfaces over regular intervals, e.g. every 20 m. Depending on the available results, further analysis can be carried out to show changes over time, the spread of results for specific types of surfaces, etc.

The results from GeoCPX measurements may be used for environmental purposes (for instance in noise maps) and for road administration purposes (to determine “black spots” due to clogging or ravelling).

### A.2.6.1 Details of the measurement method

CPX measurements are carried out using M+P’s two-wheeled CPX-trailer, set up to run tyre A in the right wheel track and tyre D in the left wheel track (i.e. the survey method defined in ISO 11819-2). The measurement speed is set to 80 km/h using cruise control in the towing vehicle. Average CPX values for both inner-position microphones are calculated for road segments of 100 m. dGPS is used to track the position of the trailer on the road network as measurements are taken. Figure A.9 shows the M+P trailer<sup>16</sup>

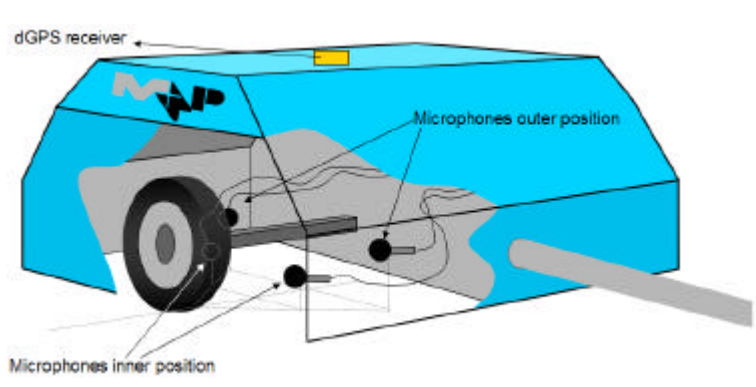

Figure A.9: M+P CPX trailer with dGPS receiver

### A.2.6.2 Example application of GeoCPX: Results for highways in the Netherlands and Belgium

As part of the SILVIA project M+P carried out three GeoCPX measurements as follows: In the Netherlands, a 100 km route on the A2 and A76 highways from Heerlen to Vught and a 50 km route on the A58/N65 highway from Breda to Vught were measured; In Belgium, a route in excess of 120km was measured on the E19/E17 from Gent via Antwerp to the Dutch border near Breda.

<sup>16</sup> It is noted that other CPX systems (e.g. TRL’s TRITON system) are available which have the capability to take CPX measurements linked to dGPS data, but have not been used for GeoCPX-type data analysis

Figure A.10 and Figure A.11 show the GeoCPX map corresponding to the route on the A76/A2.

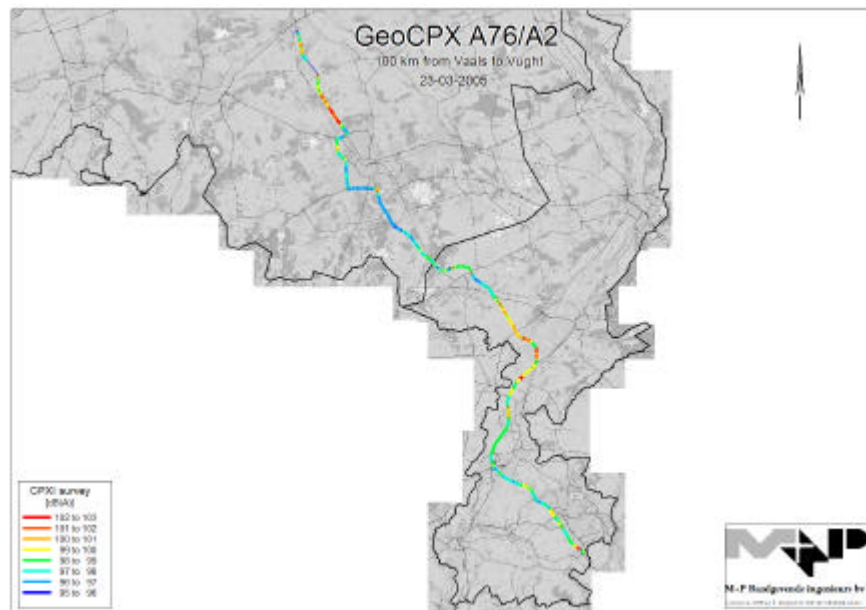

Figure A.10: GeoCPX-map of A76/A2 in southern part of the Netherlands

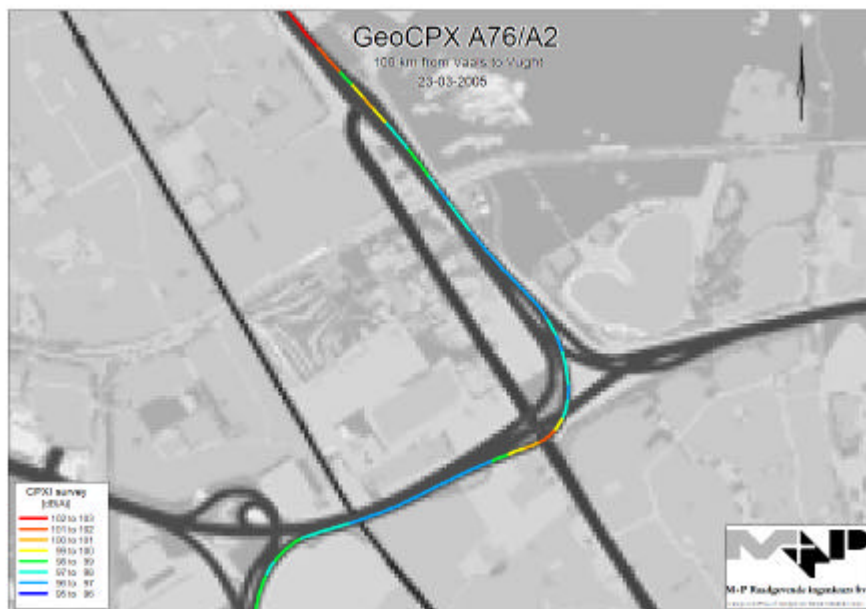

Figure A.11: Detail of the GeoCPX-map for the A2 near Eindhoven

A comparison of the GeoCPX results on the Dutch and Belgium highways, based on 100 m road segments is given in Figure A.12. The results show a spread in the rolling noise levels of approximately 10-11 dB(A). The Belgian results show higher levels which are

most likely due to the roads being rough dense asphalt and cement concrete. The results for the Dutch roads are quieter and most likely due to the wide application of porous asphalt over the selected routes

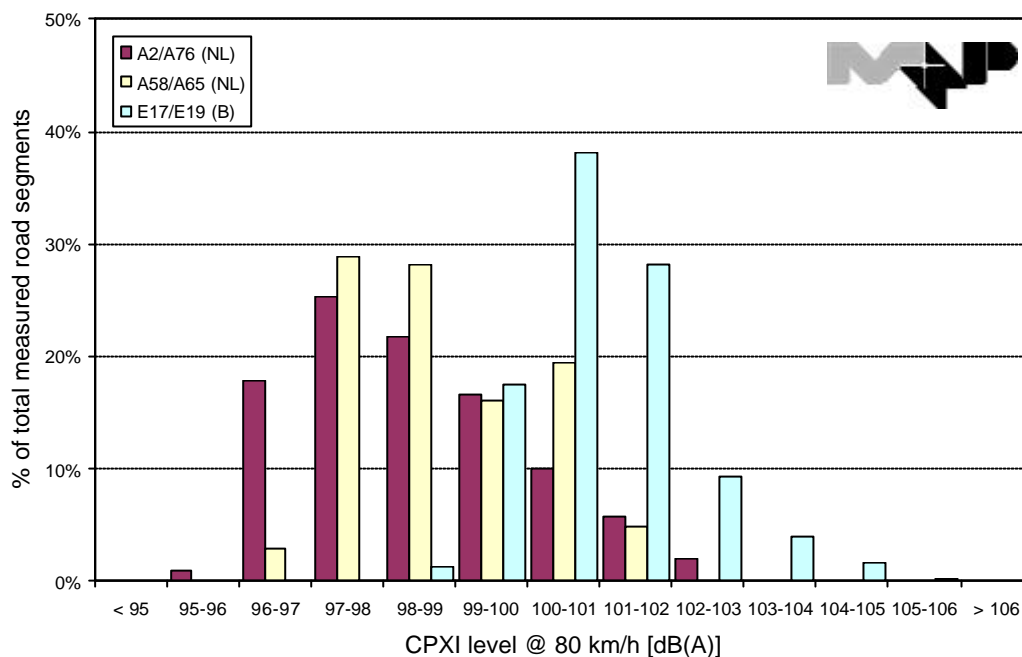

Figure A.12: Results of three GeoCPX-measurement runs in the Netherlands and Belgium

### A.2.7 Procedure for determining SILVIA CPX noise values used for labelling

For the purposes of classification and conformity of production the SILVIA CPX noise value,  $LABEL1_{CPX}$  is the average CPXI value,  $CPXI_{Average}$ , determined for each trial used in determining the SPB noise label,  $LABEL1_{SPB}$ . For each trial surface, the CPXI is determined using the *investigatory method* as described in the draft ISO Standard [113] where CPXI is calculated using the following equation:

$$CPXI = 0.20L_A + 0.20L_B + 0.20L_C + 0.40L_D \quad [dB] \quad (A.7)$$

$L_A$ ,  $L_B$ ,  $L_C$  and  $L_D$  are the Tyre/Road Sound Levels,  $L_{tr}$  for tyres A, B, C and D respectively, determined at a reference speed of 50 km/h, 80 km/h or 110 km/h. In order to distinguish between different speeds and tyres, additional suffixes are used, for example  $L_{trB80}$  refers to the tyre/road sound level for tyre B at a reference speed of 80 km/h.

It should be noted that at the time of writing, it is expected that the draft Standard will be revised in the near future, with the reference tyres being replaced; most probably there will only be two reference tyres in the revised Standard.

### A.2.8 Information to be reported for labelling

The following section provides advice on the information which should be included when reporting label CPX noise levels,  $LABEL1_{CPX}$ .

The reported data from each CPX measurement carried out at each trial location should conform to the corresponding requirements given in the ISO standard [113]. Briefly these are listed as follows:

- *General information (Date of measurement and equipment certification);*
- *Location and general appearance of test site;*
- *Road surface detail (Age, type, maximum chipping size, void content etc);*
- *Environmental factors (Average air and surface temperature etc);*
- *Details of test tyres (Date of manufacture, hardness value etc);*
- *Measured and calculated values including:*
  - *$L_{tr}$  for each reference tyre and each reference speed*
  - *CPXI, expressed to the nearest 0.1 dB;*

For the purposes of labelling, the information as described above, will be required from at least two trial locations where the reference speeds are the same. In addition, the following information should be supplied:

*The LABEL1<sub>CPX</sub> value is derived from the average CPX noise levels, CPXI<sub>Average</sub>, expressed to the nearest 0.1 dB(A).*

### **A.3 Road Surface Absorption**

As observed in Section 3.3.1.2, porous and semi-porous road surfaces exhibit important acoustical properties that can affect the generation and propagation of vehicle noise. These acoustical effects are generally combined under the term sound absorption. Several measurement methods are available which determine in either a direct or indirect way the effects of the road surface on sound absorption.

Traditionally, the absorption characteristics of porous and semi-porous surfaces are determined by firstly extracting test cores from the road surface. The test cores are then mounted in an impedance tube in accordance with the methodology defined in ISO 10534-2 [114]. However, the cores are unlikely to be truly representative of the road surface since detritus present in the road surface will tend to be washed out of the core sample due to the large volumes of water required as part of the core extraction process. Furthermore, where cores are extracted from the surface there are also problems with reinstatement and potential damage to the surface and, of course, the cores extracted only represent a small section of the road surface under investigation

Other methods, such as level difference measurements or in-situ impedance tube measurements, can also be applied with varying success. These methods overcome the problems associated with core extraction but are not particularly well suited for rapid application at multiple positions along a road surface.

### A.3.1 General description of the measurement method

The work in SILVIA has focussed on the application of the *Extended Surface Method* as described in ISO 13472-1 [115]. This is a non-destructive, normal incidence, in-situ technique which is well suited for taking measurements at multiple positions along a length of road surface. The technique can be applied under static conditions, directly in accordance with the standard, or under dynamic conditions as reported by Morgan and Watts [172] (see also [173]).

Figure A.13 shows the measurement set-up that is used for the Extended Surface Method. The measurement is based around the cross-correlation of two signals, i.e. that propagating directly from the loudspeaker to the microphone and that which is reflected from the road surface. This information is then used to calculate the sound absorption coefficient of the road surface in one-third-octave bands.

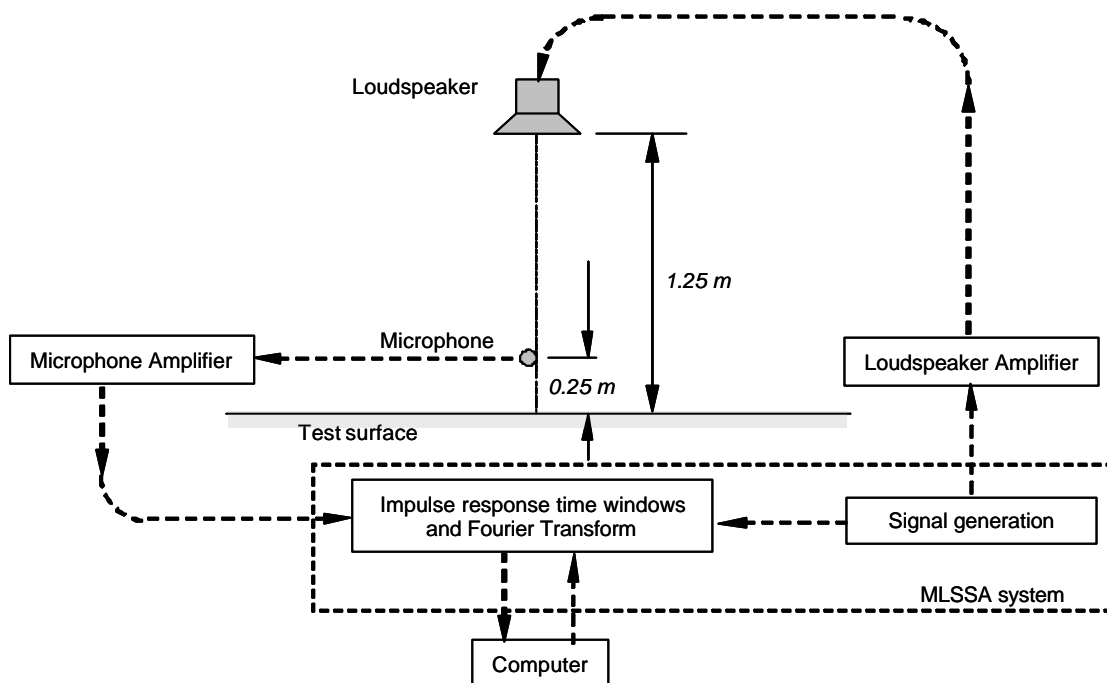

Figure A.13: Extended surface measurement set-up in accordance with ISO 13473-1 (the indicated MLS signal is nowadays frequently replaced by a modified frequency sweep)

The measurement principle of the method is that a microphone positioned 0.25 m above the surface, measures the sound signal from a source placed 1.0 m above the microphone. This signal comprises a component coming directly from the source and a part that arrived at the microphone after reflection at the surface under test. The quotient of both complex spectra (of which the reflected is corrected for the longer source-receiver distance) directly gives the complex spectral impedance. From this the frequency dependent absorption can be derived. The actual data processing is done in the time domain and uses a reference measurement with the whole system oriented upwards to determine the direct signal without contamination from the reflected part.



### A.3.2 Representativity of descriptive parameters for sound absorption

The sound absorbing properties of a road surface is strongly dependent on the acoustic frequency of the incident sound wave. Examples of the sound absorption spectra for a porous asphalt road surface is given in Figure A.14. It can be seen that the peak of the absorption spectra is dependent on the thickness of the layer.

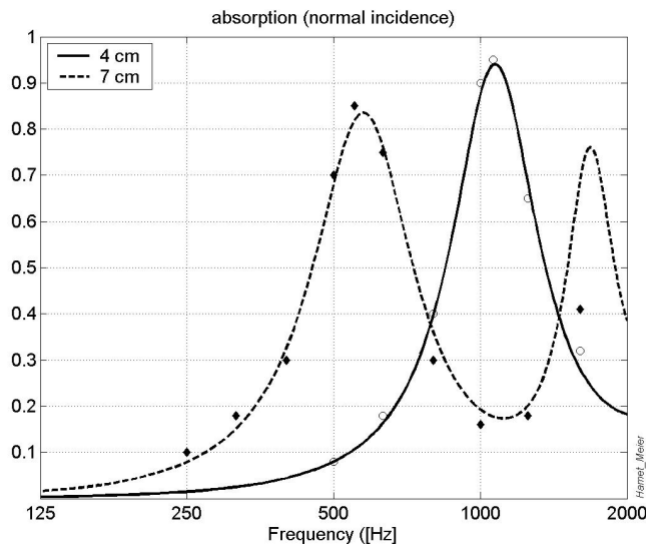

Figure A.14: Typical absorption spectra for a porous asphalt surface. The thickness of the surface defines the frequency of maximal absorption, solid line: 40 mm, dashed line: 70 mm thick.

The typical absorption curves are described by:

- $a_{max}$ : the value at which the measured absorption curve reaches its first maximum;
- $f_{a,max}$ : the frequency at which the measured absorption curve reaches its first maximum;
- $a_{max}$  is related to the porosity and air flow resistance of the absorbing material,  $f_{a,max}$  is defined by the effective layer thickness of the material (given by the actual layer thickness and the tortuosity).

However, it is more effective to describe the absorption properties in terms of a single number rating that is representative of the actual effect on vehicle noise; such a system would simplify the direct ranking of road surfaces, based on absorption properties. This single number for sound absorption is supposed to give an estimation of the noise reduction due to acoustic absorption by the surface as compared to the same surface, but with no absorption at all. Such a scheme has been developed by Klein and Hamet [116] as part of the SILVIA project and is referred to as the **Expected pass-by Noise level Reduction from acoustic absorption of the road surface**,  $ENR_a$ . The estimated effect, given in dB is calculated by the following formula:

$$ENR_{\alpha} = 10 \times \log 10 \left( \frac{\sum_{i=3}^{18} 10^{\left( \frac{L_{i,ref} - 12\alpha_i}{10} \right)}}{\sum_{i=3}^{18} 10^{\frac{L_{i,ref}}{10}}} \right) \text{ dB} \quad (\text{A.8})$$

with  $i$  denoting the third-octave bands between 250 Hz and 4 kHz,  $L_{i,ref}$  denoting a certain defined reference spectrum for road traffic noise and  $\alpha_i$  denoting the measured absorption in the  $i^{\text{th}}$  third-octave band. The  $ENR_{\alpha}$  characterizes the reduction of pass-by noise by acoustic absorption of the road.  $ENR_{\alpha}$  does not solely depend on the acoustic absorption of the road surface; it also depends on a reference pass-by noise level.

### A.3.3 Single number rating for SILVIA classification/COP system

For porous surfaces, the SILVIA classification system requires that the absorption properties of the trial length selected for labelling does not significantly vary along its length. The procedure requires that a series of spot measurements of the absorption spectra is carried out along the trial length. The absorption properties of the surface at each spot position is compared with the average spectra over the whole trial length. This comparison is evaluated using a single number descriptor, developed by Klein and Hamet [116], called the **Expected Noise Difference** due to a difference in acoustic absorption,  $END_{\alpha}$ , given by:

$$END_a = 10 \log \left( \frac{\sum_i 10^{\left( \frac{L_{Amax,1,vref,i} - 12\Delta\alpha_i}{10} \right)}}{\sum_i 10^{\left( \frac{L_{Amax,1,vref,i}}{10} \right)}} \right) \text{ dB} \quad (\text{A.9})$$

where

- $L_{Amax,1,vref,i}$  is the third-octave band spectral level in each third-octave band,  $i$ , measured at the maximum pass-by noise level,  $L_{Amax,1,vref}$ , for category 1 vehicles at a reference speed  $v_{ref}$  km/h
- $\Delta\alpha_i$  is the third-octave band absorption spectra difference between the average absorption coefficient and the absorption coefficient for each spot position along the same surface

This descriptor is based on the **Expected pass-by Noise level Reduction** from acoustic absorption of the road surface,  $ENR_a$ , described earlier.

For the purposes of labelling, the traffic noise spectra used in Equation (A.8) is replaced by a vehicle noise spectra,  $L_{Amax,1,vref,i}$ , determined from SPB measurements carried out midway along the trial length. In addition,  $\Delta\alpha_i$ , is the third-octave band absorption coefficient difference, in each third-octave band,  $i$ , between the average absorption coefficient over whole of the 100 m section identified for labelling, ( $\alpha_{i,Average}$ ) and the absorption coefficient for each spot position under consideration ( $\alpha_{PT,i,n}$ ).

For the purposes of COP, the traffic noise spectra used in Equation (A.8) is replaced by the third-octave band spectra for category 1 vehicles, reported with the SPB noise label,  $LABEL2_{SPB}$ , for the equivalent surface type. In addition,  $\Delta\alpha_i$ , is the third-octave band absorption coefficient difference, in each third-octave band,  $i$ , between the average absorption coefficient defined by  $LABEL2_{Absorption}$ , ( $\alpha_{i,Average}$ ) and the absorption coefficient for each spot position under consideration ( $\alpha_{PR,i,n}$ ).

It should be noted that the development of the algorithms expressed in Equations (A.8) and (A.9) assumes that the corresponding vehicle noise spectra have been normalised at a reference position, 1.2 m above the road surface and 7.5 m from the centre of the vehicle path. Furthermore, these equations have not been validated experimentally and therefore their application should be used with caution.

### A.3.4 Repeatability and reproducibility of sound absorption measurements

The SILVIA Round-Robin Test [168] has demonstrated that the Extended Surface Method, including the method as applied using the mobile MIRIAD system developed by TRL (Figure A.15), can be applied with a good repeatability and a reasonable reproducibility when the acoustic absorption characteristics of the test surface are moderate to high.



Figure A.15: Mobile MIRIAD system developed by TRL for extended surface method measurements of sound absorption

Differences of the determination of the value for  $ENR_a$  between results on one road surface are 2.0 dB(A) (peak-to-peak).

The results on the test tracks display a total scatter in the determination of  $a_{max}$  between 0.05 and 0.14 at different road surfaces. The determination of  $f_{a,max}$  displays a scatter between 0 and 185 Hz at different road surfaces.

An important source of scatter is the time window applied to window out the impulse response. A rectangular time window is the optimal one to achieve a good frequency resolution, but causes strong distortion when the signal is not zero at the beginning and end of the window. A "safe" window is a Hanning or cosine window, which exhibits a

smooth weighting at both sides of the time window but broadens and flattens the frequency response considerably. This explains the major part of the differences found between the mobile system and the stationary systems.

Measurements on a calibration material (Figure A.16) show differences in the determination of  $\alpha_{max}$  of up to 0.30 for individual one-third-octave bands using the different measurement systems. However, it is noted that at low levels of absorption the accuracy of the method is poor. For system comparison a material with a known absorption would be desirable. Further research on a calibration material is recommended.

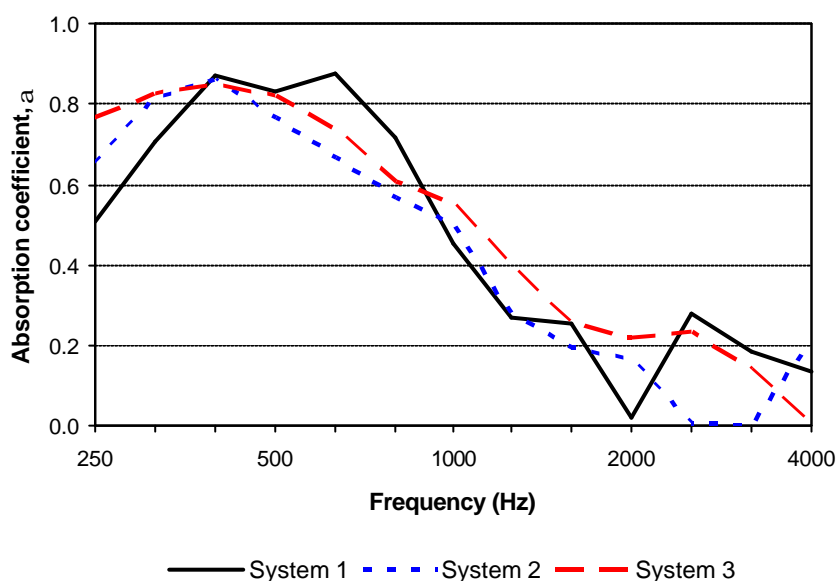

Figure A.16: Reproducibility of the measurement of sound absorption on a highly absorptive material using different measurement systems

The agreement between results taken using static measurements at regular intervals along a surface and a single corresponding dynamic measurement is dependent upon the homogeneity of the surface along the test length in terms of construction and/or the presence of oil and other detritus. It has been shown that good correlation between static measurements taken at 2 m intervals along a surface and dynamic measurements on the same surface can be achieved for dynamic speeds of approximately 15 km/h.

## A.4 Road Surface Texture

The road surface texture is considered to be the most important intrinsic parameter of a road surface influencing the rolling noise of road traffic. Texture wavelengths of about 0.5 mm to 500 mm are relevant for the noise emission (interior and exterior). This range contains both the mega- and macro texture, as shown in Figure A.17.

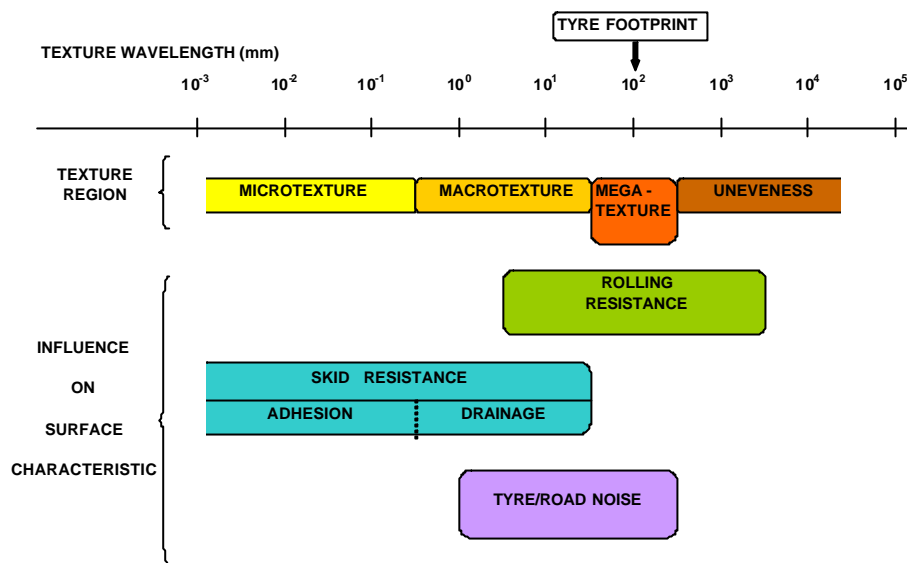

Figure A.17: Ranges in terms of texture wavelength and spatial frequency of texture and unevenness and their most significant, anticipated effects

#### A.4.1 General description of the measurement method

The ISO standards 13473-1 to 3 [117, 118, 119] and ISO-draft 13473-4 [120] address the measurement of the texture of road surfaces using laser profilometers (see Figure A.18). Common now is the application of laser triangulate sensors to perform non-contact measurement of the height of the road surface in relation to a given reference plane. By moving this sensor along a road surface, a profile along the path of the sensor can be made. Both mobile and stationary systems are now available. To obtain information on surface profile over a wider range, several sensors can be mounted in parallel. Further developments allow x-y scanning to obtain full-3-D representation of the surface.

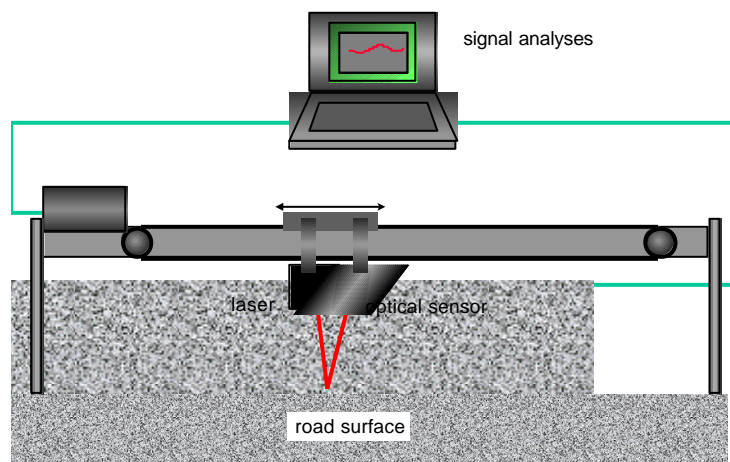

Figure A.18: Schematic representation of a static surface texture profilometer

#### A.4.2 Representativity of descriptive parameters for surface texture

Recent models that have been developed to predict the influence of the road surface texture on tyre/road noise requires an understanding of the time varying contact forces between the tyre tread and the texture profile across the full width of the tyre. Such models are complex and involve knowledge of the dynamic properties of the tyre. However, some success has been found in a simpler approach, but one which is still relevant for the prediction of noise emission. This approach models the static contact forces on the tyre by equating the downward force exerted by the tyre inflation pressure with the upward force due to the deformation of the tyre tread by the indentation of the texture profile, taking into account the stiffness of the rubber, characterised by the Young's Modulus,  $E$ , see Figure A.19. Such an approach has been reported by Klein and Hamet [174], and Beckenbauer and Kuijpers [175].

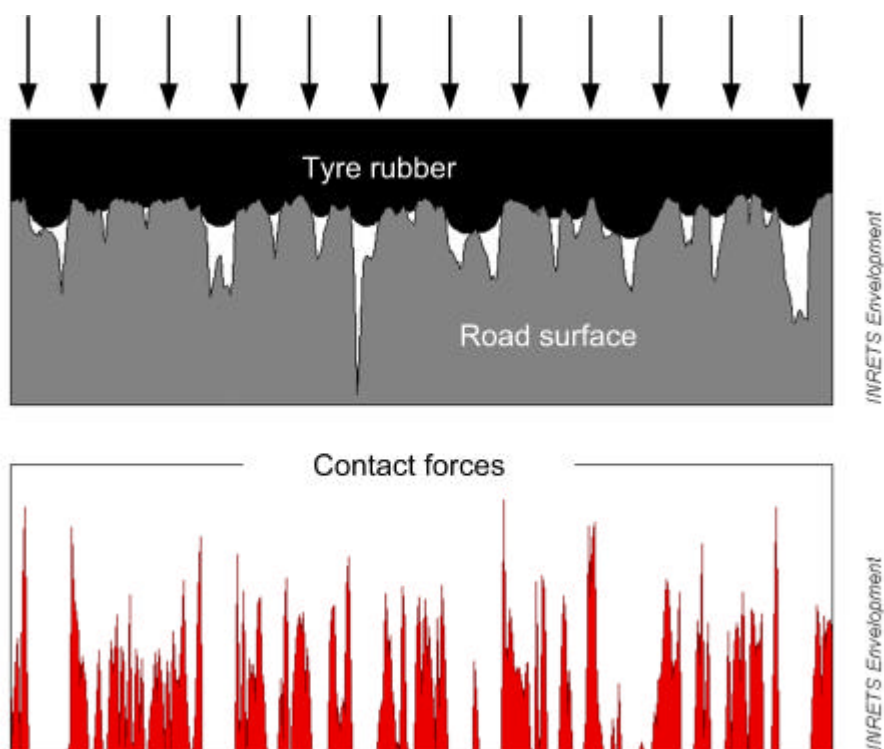

Figure A.19: Contact pressure modelling. In this model, the tyre is indented by the road texture profile. The rubber deformation creates a reaction pressure that should be in equilibrium with the tyre inflation pressure (Calculation result using INRETS enveloping procedure)

The force versus position relationship is transferred to a force versus time plot, by taking into account the vehicle speed. The resulting force spectrum is then used as input into a prediction model, SPERON [175, 159], used for estimating tyre/road noise emissions.

The procedure reported by Klein and Hamet [174] has been adopted as the enveloping procedure for use within the SILVIA classification system described in Appendix C. This procedure, which is described in a subsequent report by Klein and Hamet [176] is summarised in Section A.4.4.

### A.4.3 Single number representing texture effect on noise

The SILVIA classification system requires that the texture properties of the trial length selected for labelling does not significantly vary along its length. The procedure requires that a series of texture profile measurements are carried out along the trial length. The texture profile from each measurement is compared with the average profile over the whole trial length. For classification purposes a single parameter evaluation  $END_T$ , the estimated pass-by noise level difference from texture level variations, has been developed within the SILVIA project by Klein and Hamet [121] to assess deviations in texture during both the labelling and COP procedure. The approach is similar to that of absorption characteristics and the single number rating proposed here is based on the enveloped texture information.

This seems a good compromise between calculation simplicity (envelopment procedure as compared to dynamic rolling) and pertinent texture information (using enveloped texture yields a better correlation than using rough texture).

It is given by the relation:

$$END_T = 10 \times \log_{10} \frac{\sum_i 10^{(L_{A_{max,1,vref,i}} + b_i \cdot \Delta L_{eT,i})/10}}{\sum_i 10^{L_{A_{max,1,vref,i}}/10}} \text{ dB} \quad (\text{A.10})$$

where

- $L_{A_{max,1,vref,i}}$  is the third-octave band spectral level in each third-octave band,  $i$ , measured at the maximum pass-by noise level,  $L_{A_{max,1,vref}}$ , for category 1 vehicles at a reference speed  $v_{ref}$  km/h
- $\Delta L_{eT,i}$  is the third-octave band enveloped texture level difference (see Section A.4.4 for further details on enveloping) at a given speed  $v$  between the average enveloped texture and the enveloped texture measured at different locations along a same surface;
- $b_i$  is the regression slope calculated for each third-octave band (see Table A.7).

The coefficients,  $b_i$ , have been derived from correlations between enveloped texture levels and noise power levels in the frequency range associated with noise caused by tyre vibrations (= 1000 Hz). Although these coefficients  $b_i$  depend, strictly speaking, on the rolling speed. Fixed values are however proposed (Table A.7), which are the average values of the regression slopes obtained for  $v = 80$  km/h and  $v = 130$  km/h, rounded down.

Table A.7: Texture versus noise level coefficient,  $b_i$ , for calculating  $END_T$

f (Hz)	250	315	400	500	630	800	1000	1250	1600	2000	2500	3150	4000
$b_i$	0.90	0.85	0.80	0.75	0.70	0.65	0.40	0.0	0.0	0.0	0.0	0.0	0.0

The above procedure addresses the influence of texture profile on noise radiating due to tyre vibration which, for porous surfaces, where the effect of air pumping on noise generation is less dominant, provides an adequate method for examining acoustic homogeneity due to variation in texture. However, for dense surfaces, an additional parameter is required to take into account the influence of texture levels at high spatial frequencies which are thought to influence noise radiation due to air pumping and takes the form:

$$END_T = 10 \times \log_{10} \frac{\sum_i 10^{(L_{A \max, i, v_{ref}} + b_i \cdot \Delta L_{eT, i})/10}}{\sum_i 10^{L_{A \max, i, v_{ref}}/10}} - 0.25 \cdot L_{T, 5mm} \quad \text{dB} \quad (\text{A.11})$$

where  $L_{T, 5mm}$  is the texture level difference in the 5 mm wavelength octave band between the labelling and the COP.

It should be noted that this approach is limited to passenger car tyres. The effect of texture on truck tyres can be very different and requires further study.

For the purposes of labelling,  $\Delta L_{eT, i}$  is the third-octave band enveloped texture level difference at a given speed  $v_{ref}$  km/h between the average enveloped texture over the whole of the trial length and the enveloped texture measured for the segment or spot position under consideration. In addition where the surface is dense,  $\Delta L_{T, 5mm}$  is the texture level difference in the 5 mm wavelength octave band between the average texture over the whole of the trial length and the enveloped texture measured for the segment or spot position under consideration.

For the purposes of COP,  $\Delta L_{eT, i}$  is the third-octave band enveloped texture level difference at a given speed  $v_{ref}$  km/h between the average enveloped texture spectrum reported under  $LABEL2_{Texture}$  procedure and the enveloped texture measured for the segment or spot position under consideration. In addition where the surface is dense,  $\Delta L_{T, 5mm}$  is the texture level difference in the 5 mm wavelength octave band between the average texture level reported with the label ( $LABEL2_{Texture}$ ) and the texture level measured for the segment or spot position under consideration.

It is recommended that static measurements of texture at spot positions are carried out over a minimum length of 5 m to provide a valid estimate of  $END_T$  for vehicle speeds up to 130 km/h.

It should be noted that the development of the single number rating algorithms expressed in Equations (A.10) and (A.11) are based on a set of measured textured profiles which may not be representative of all road surface types and on noise data obtained by numerical simulation. Further experimental work to validate these results is recommended and, in the meantime, the application of the procedure described above should be used with caution.



#### A.4.4 Analysis of texture profiles for use with the SILVIA classification scheme

The INRETS enveloping procedure [176] evaluates the contact between a two-dimensional profile of length  $L$  pressed on an elastic half-space with a mean pressure  $P$ . The average of the pressure distribution  $p(x)$  taken over the contact zone  $C$  must equal the applied pressure  $P$ , i.e.

$$\frac{1}{L} \int_{(C)} p(x) dx = P. \quad (\text{A.12})$$

The displacement  $u(x)$  of the surface of the elastic half-space is related to the pressure distribution in the contact zone by the relationship [177]

$$u(x) - u(x_0) = -2 \frac{1 - \nu^2}{\pi E} \int_{(C)} p(\xi) \ln \left| \frac{\sin \pi(\xi - x)/L}{\sin \pi(\xi - x_0)/L} \right| d\xi \quad (\text{A.13})$$

where  $x_0$  is a reference point chosen to be the first possible contact between the half-space and the texture profile. The numerical values used for the parameters are  $\nu = 0.5$ ,  $E = 106 \text{ N/m}^2$  and  $P = 2 \times 10^5 \text{ Pa}$ .

The calculation requires that the contact surface be known. An iterative procedure, based on Kalker's algorithm [178], is thus used. It is described in a report by Poinas [179] and works on two principles:

- **Principle 1:** if at  $x$  there is an interpenetration between the half space and the profile, there is contact at  $x$ ;
- **Principle 2:** if at  $x$  the calculation yields a negative pressure, there is no contact at  $x$ .

The flow chart of the algorithm can be found in the report by Poinas [179].

#### A.4.5 Reproducibility

The four measurement systems tested in the SILVIA Round-Robin Test [168] were compared on the basis of the relevant single number results, the most relevant being the  $END_T$ . For the  $END_T$  comparison, the extra term for dense surfaces was applied in the appropriate situations.

Table A.8: Reproducibility in terms of the standard deviation of the determination of texture parameters by four measurement devices

Tyre Enveloping Filter	MPD mm	ETD mm	RMS mm	$\sigma_{\max}$ mm	$L_{r,\max}$ dB	g	ERNL dB(A)	$END_T$ dB(A)
No	0,20	0,16	0,14	3,68	1,42	8,49	0,87	xx
Yes	0,18	0,14	0,12	12,41	2,23	5,11	0,72	0,73

The standard deviation found within the  $END_T$  values (expressed as the differences between each pair of measuring devices at each surface tested) can be interpreted as an accuracy of  $\pm 1.1$  dB with 80% coverage.

#### **A.4.6 Calibration of texture devices**

During the SILVIA Round Robin-Test [168], results obtained from using the different measurement systems to measure on two types of calibrating profiles (a block shaped profile and a triangular profile) were also compared. Several single value parameters were determined with the profiles. The RMS value is a valid descriptor for the calibration results. Regarding this parameter the results for the triangular pattern show a good match for all three measurement devices (all differences smaller than 0.05 mm). For the block pattern differences of 0.6 mm, 0.2 mm and 0.1 mm were found.

It was concluded that:

- A block shaped calibration profile was less suitable for the functioning of the devices compared to the triangle form;
- The calibration did only give indications of the functioning of the systems, but could not be used for determining correcting values.

### **A.5 Measurement methods for additional Surface Characteristics**

This section addresses measurement methods that are related to surface characteristics that have a secondary importance on tyre/road noise emissions compared with texture and absorption. With further research, these methods may be developed to a stage where they can be satisfactorily used for COP assessment purposes on appropriate road surfaces, or for more general investigation of performance characteristics related to low-noise road surfaces.

#### **A.5.1 Mechanical impedance**

The mechanical impedance, or dynamic stiffness, of a road surface can be measured by applying an impact to the road surface and registering the response of the material in terms of its vibration. This simple procedure has been practically implemented in two kinds of measurement systems:

1. A system whereby the measurement of the response is made at the same place at which the impact is applied. This implementation needs a detailed modelling and tuning approach of the dynamic behaviour of the measurement system which affects the measurement results.
2. A system whereby the measurement of the response is made at fixed distances on the horizontal plane from the place at which the impact is applied. This implementation needs a detailed modelling approach of the medium in which waves travel from the place of the impact to the measurement locations. Such a

transfer method has been developed in the SILVIA project by LCPC and showed a promising correlation with laboratory characterisation of stiffness on road core samples [180].

As part of the SILVIA project, a spot method has been developed by M+P based on earlier work by Nilsson and Sylwan [181]. The apparatus for this method consists of an aluminium ground plate with a diameter of 40 mm and a height of 10 mm. A force sensor is mounted on the top of this ground plate. An accelerometer is then mounted in housing on top of the force sensor. The accelerometer housing is then struck with an impedance hammer. In this way, an in-line synchronous measurement of the force and the velocity can be achieved (system (i) as described above) instead of measuring the two at a fixed distance apart in the horizontal plane. Figure A.20 shows the apparatus developed by M+P and the work is described in more detail in the SILVIA Project Report by Kuijpers and Schwanen [122].



*Figure A.20: Measurement system for mechanical impedance developed by M+P (The narrow part on top of the ground plate is the force transducer; the upper-part being struck by the impedance hammer comprises an accelerometer and its housing)*

The principles behind the procedure for measuring the mechanical impedance for roads have been demonstrated. However the actual measurement method requires further development. Several aspects require to be investigated including the geometry of the excited area, the pre-applied load and the spread of the force over the contact area. An optimum design for the measurement apparatus must also be developed.

As such the system can be satisfactorily applied for R&D purposes. However, the issues described above and others relevant for standardization have to be addressed before the method can be applied on a wider scale and used as a standard part of COP procedures for open-graded, elastic road surfaces. Therefore, no further details are included in this Guidance Manual.

## **A.5.2 Rolling resistance**

The rolling resistance of a tyre on a road surface is responsible for a significant part of the energy consumption of the vehicle. Comparing different types of road surfaces, differences in rolling resistance of up to 32% have been observed [183]. A direct procedure for determining this property is to measure the force required to tow the tyre at a constant speed. An indirect way is to assess the fuel consumption of a vehicle.

In a recent study these two approaches were compared and for each approach two systems [183]. It was found that the correlation between the two approaches was very low, but that between the two towing based types a very good correlation was found, as shown in Figure A.21.

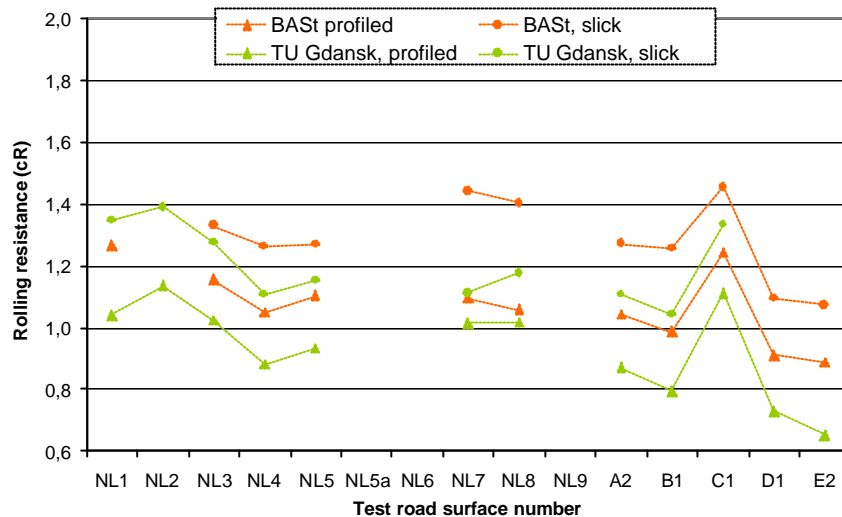

Figure A.21: Results of measurements of the rolling resistance on 15 different road surfaces. Two systems (from TUG and from BAST) were applied with two types of tyres. Although the levels differ significant, their mutual relation is stable. Differences can be explained by the slightly differing measuring methods (from [183])

As rule of thumb, a certain difference in rolling resistance implies a difference in energy consumption of the vehicle (and thus CO<sub>2</sub>, NO<sub>x</sub> and fine particle emission) of ¼ of this. Thus 32% difference in rolling resistance leads to about 8% lower fuel consumption.

Tyre rolling resistance may be measured both on the road and in the laboratory. Measurements on the road are generally more difficult to conduct but account better for road surface characteristics, and so are preferred when the goal is to evaluate road surface influence on rolling resistance. Laboratory methods give better reproducibility and repeatability but it is difficult to use them to test the road surface influence.

Various existing road-based measurement approaches are available, including coast-by, “rolling down a hill”, driving torque, maximum speed and towed vehicle methods. However, there are inherent difficulties with all of these approaches. Further details are given in the SILVIA Project Report by Ejsmont *et al.* [32].

As part of the SILVIA project, TUG have carried out rolling resistance measurements using a purpose-built trailer, as shown in Figure A.22, to try to develop an improved method. However, only a limited number of surfaces were studied and further research is required [32]. No further details are included in this Guidance Manual.

The present widening interest in air quality and pollution, may lead to the application of roads with low rolling resistance in the future, at which point reliable measuring systems should be available. However, no requirement for standardization is foreseen at the present time.

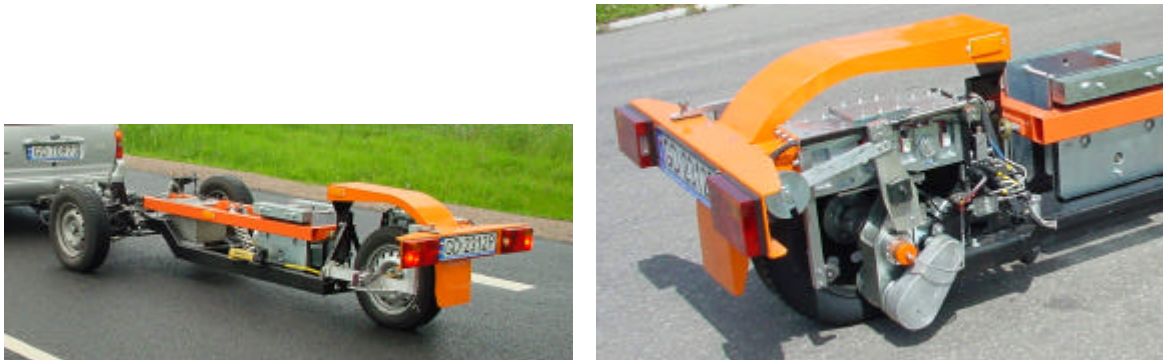
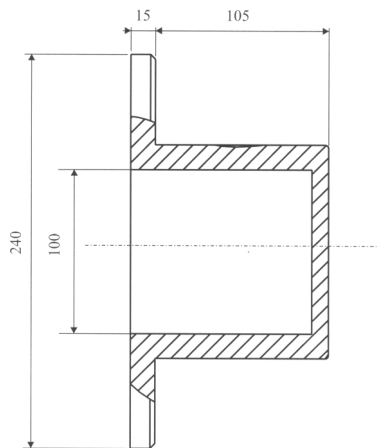

Figure A.22: Rolling resistance trailer developed by TUG [32]

### A.5.3 Airflow resistance measurements

As part of a project reported by Hübelt *et al.* [184] to develop methods for the characterisation of the acoustical properties of open porous road surfaces, a method based on the measurement of the effective airflow resistance has been tested.

The determination of the effective air-flow resistance  $R'_s$  is carried out according to ISO 9053 [123], although it is recommended to use the “comparing method” proposed by Stinson and Daigle [124]. This procedure is a variation of the laminar air-flow-method described in the ISO Standard.



(a) Adapter for road surfaces

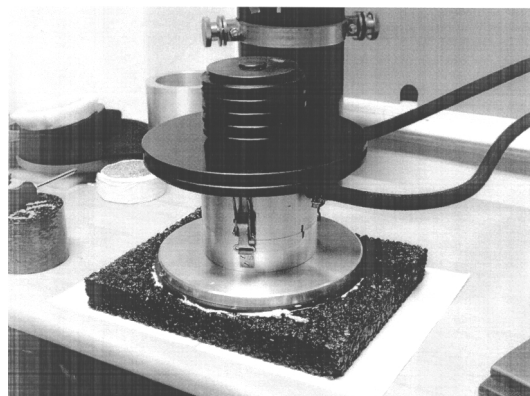

(b) Laboratory measurement on a sample of porous road surface

Figure A.23: Measurement of the effective specific airflow resistance of porous road surfaces

The measurement of the effective specific air-flow resistance  $R'_s$  on a road is carried out by fitting the standard laboratory measurement apparatus with a cylindrical adapter incorporating a rim (Figure A.23a). This adapter is to be put directly on the road surface. The radius of the rim is 12 cm and is optimised for the thickness of the asphalt and the expected flow resistance. For studies investigating the sustainable development of acoustically effective open porous asphalt, the rim has to make an airtight seal with the road surface; this can be achieved using a glued silicon ring (Figure A.23b).

With further standardisation of the test apparatus, this method could be used as an alternative to the Extended Surface Method described in ISO 13472-1 [115].

## Appendix B. Procedure for the certification of measurement apparatus

This Appendix sets out the recommended procedures for the certification of measurement apparatus and systems that are used for the measurement of acoustic and non-acoustic parameters. It is pointed out that these procedures are not mandatory nor standardised (unless drawn from appropriate ISO standards).

The full documentation on Certification Procedures can be found in the text of the SILVIA Project Report by Ejsmont *et al.* [169] (also [170]).

### B.1 CPX trailers and vehicles

The certification procedures for CPX apparatus are primarily concerned with ensuring the CPX measurements are unaffected by noise from unwanted sources. The main sources of background noise likely to affect CPX measurements can be summarised as follows:

- **Aerodynamic noise:** This is due to airflow and dependent on the ambient air and wind speeds in relation to the speed at which the microphone moves (the latter generally being the vehicle speed). For a trailer without any form of enclosure around the microphone(s), this noise is mainly generated by the largely turbulent airflow around the microphone(s). For a trailer fitted with an enclosure, the lower edge of the enclosure could itself be responsible for additional turbulent airflow noise. A vehicle having CPX microphone(s) mounted outside one of its wheels will create substantial air turbulence that will add to the airflow around the microphone when it moves along with the vehicle in the ambient air;
- **Noise generated by supporting wheels:** Wheels on self-powered test vehicles and any additional wheels fitted to trailers to provide support/stability may contribute to the background noise depending on the distance to the microphone(s) and windshields;
- **Vibration-induced noise:** Produced by the trailer structure due to the tyre/road interaction, this may possibly be transmitted to the enclosure and then radiated from it;
- **Suspension noise:** Generated by the suspension of the test tyre;
- **Bearing noise:** Generated by the bearings and hub assembly of the test wheel;
- **Noise from the towing vehicle:** This includes contributions from the engine, exhaust and tyres;
- **Other noise sources:** e.g. incidental contact between the enclosure and the road surface, passing vehicles, horns and so on). In case of such noise interference, actions should be taken by the instrument operator to make sure that their effect on the final result is eliminated.

Direct measurement of the background noise cannot easily be done, particularly for CPX trailers where the only support for the trailer comes from the measurement wheel.

### **B.1.1 Determination of hub assembly noise**

To measure hub assembly noise it is necessary to rotate the test wheel, without any contact between the test tyre and road. Although, under this condition the bearings are not properly loaded, nevertheless if the bearings are faulty or worn, the excessive noise will be recorded. In order to keep all acoustical conditions similar to the normal measurements it is not recommended to test the hub without the wheel fitted. The measured noise levels will be a contribution of hub assembly noise, aerodynamic noise generated by the tyre tread and ventilation noise generated by the wheel rim. It is therefore important not to use wheel rims on the CPX trailer/vehicle that have strong ventilation effects (although the selection of rim must be balanced with the need to provide sufficient ventilation during routine CPX measurements to avoid overheating of the wheel bearings).

Table B.1 shows reference spectra measured for ISO tyres B and D and the smooth PIARC tyre, all of which were measured on a specially quieten hub using a low ventilation rim. These spectra can therefore be considered as being solely due to the aerodynamic noise generated by the passage of the tyre tread through the air ("ventilation noise").

The suggested certification procedure is as follows:

1. Connect the test wheel hub assembly to an appropriate external power unit and ascertain that the measuring area around the wheel is well screened from the noise of the power unit. If necessary, the hub assembly may be removed from the test vehicle and mounted on a separate supporting jig.
2. Spin the wheel to the speed corresponding with CPX test speeds.
3. Measure the noise at the standard CPX microphone positions. Since the wheel is lifted above the ground surface, the microphone positions should be based on the distance below the centre of the wheel axle (the same distance as would be used if performing actual CPX measurements).
4. Compare the measured results for the selected CPX/PIARC tyre (from 315 - 4000 Hz) with the reference spectra presented in Table B.1.
5. If the measured levels are greater than the reference levels by 10 dB or more, then this is an indication of a noisy hub. If such situations occur, it is recommended to compare the measured spectra for the hub assembly noise with a tyre/road noise spectrum for ISO tyre A on the ISO reference surface. If the signal-to-noise (S/N) ratio is greater than 15 dB, then the hub quality is acceptable.



Table B.1: A-weighted ventilation noise spectra for the ISO tyres B and D and the smooth PIARC tyre

Freq (Hz)	v=70 km/h			v=110 km/h			v=160 km/h		
	PIARC	Tyre D	Tyre B	PIARC	Tyre D	Tyre B	PIARC	Tyre D	Tyre B
100	37.5	37.0	42.5	41.9	42.9	43.5	47.1	53.2	51.6
125	41.1	36.4	41.6	52.0	46.5	46.5	52.2	54.3	53.1
160	47.5	39.7	48.5	53.0	47.6	52.2	57.8	54.2	57.5
200	54.4	45.9	57.2	58.3	51.9	58.1	63.1	56.7	62.6
250	56.3	51.4	57.8	62.8	56.3	63.6	68.7	61.4	68.6
315	53.1	51.1	54.9	65.1	59.5	68.7	70.4	63.5	71.3
400	48.2	49.7	50.3	65.9	60.5	66.7	71.5	65.2	73.7
500	47.3	50.5	49.3	62.3	60.6	62.1	75.6	71.2	77.7
630	42.8	52.2	46.8	57.4	61.1	58.6	75.5	72.3	76.3
800	41.7	53.3	47.0	56.2	62.4	57.7	70.5	72.0	71.2
1000	37.8	53.1	47.4	50.0	62.8	55.5	64.2	73.0	66.6
1250	36.9	52.7	48.0	48.7	63.2	56.4	62.7	74.0	66.3
1600	37.1	52.9	48.4	47.7	63.4	58.0	60.2	74.9	66.3
2000	37.4	52.7	48.8	48.8	63.3	59.1	60.3	75.4	67.7
2500	36.1	51.9	47.3	47.8	62.2	57.7	58.7	74.5	67.9
3150	33.4	51.0	45.7	45.7	61.2	56.6	56.2	73.3	67.3
4000	32.3	49.8	44.1	45.1	60.7	55.9	55.5	72.2	66.3
5000	31.4	47.8	41.4	42.8	59.3	53.7	53.2	70.8	64.8
6300	26.5	46.2	38.2	41.4	58.4	52.4	53.0	70.8	64.2
8000	23.1	44.0	34.5	39.2	57.1	50.5	51.3	69.6	62.9
10000	19.3	41.4	29.8	35.4	55.6	47.7	48.3	68.5	61.6
LA	60.7	63.4	63.5	71.2	73.4	73.5	81.0	84.4	83.1

### B.1.2 Determination of supporting wheel noise

Many CPX vehicles utilize extra supporting wheels located in front of the test wheel, to either side, or at the front and rear corners of the vehicle/trailer. These wheels may contribute to the measured noise and it is therefore necessary to evaluate this contribution.

The best method to establish the level of the background noise coming simultaneously from the supporting wheels and the towing vehicle, as well as any aerodynamic noise is the "**Lifted/Removed Tyre Method**" which is described in ISO/DIS 11819-2 [113]. Whenever possible, this method should be used. Unfortunately this method cannot always

be applied if the CPX vehicle/trailer uses the test wheel(s) as part of its suspension system such that the test wheel supports part of the vehicle/trailer load to main stability.

If the “*Lifted/Removed Tyre Method*” cannot be used, the noise emitted by the supporting wheels and the towing vehicle should be determined separately. To establish the background noise from supporting wheels alone, one of two methods should be used, i.e. either the “*direct*” method (based on measurements at the standard positions performed on a drum, with the supporting wheels (or at least one of them) rolling on the drum which should be fitted with a replica road surface; ideally all supporting wheels should be tested on the drum simultaneously), or the “*indirect*” method (based on measurements taken close to the supporting wheel during standard CPX measurements). The “*direct*” method is preferable and should be used wherever feasible. The basic measurement set-ups for the two methods are shown in Figure B.1

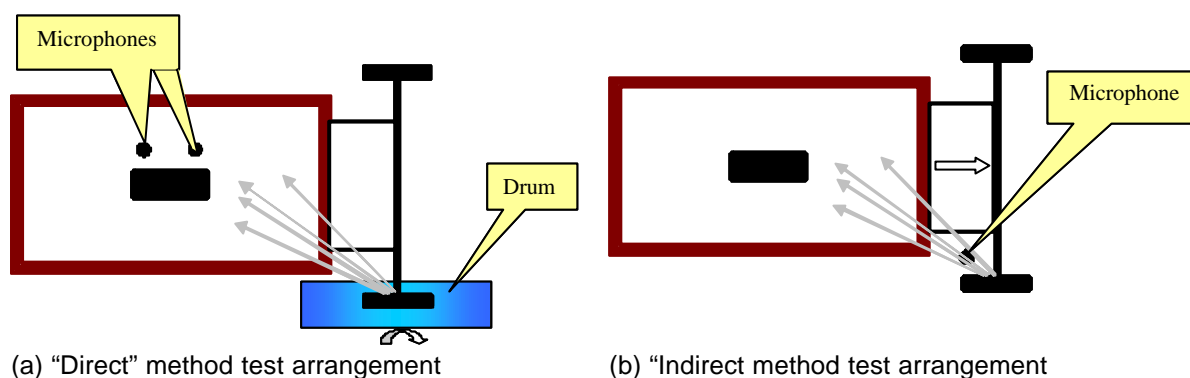

Figure B.1: Test arrangements for the “*direct*” and “*indirect*” methods for evaluating the noise of supporting wheels

The suggested certification procedure using the “*direct*” method is as follows:

1. Position the CPX vehicle in such a way that its supporting wheel (or in case of the self-powered vehicle its “basic”<sup>17</sup> wheel) rests on the test drum equipped with replica road surface.
2. Rotate the drum to speeds 50, 70 and 90 km/h and measure the noise ( $L_{Aeq}$  and spectra from 315 - 4000 Hz) at the standard CPX microphone positions (i.e. close to the test wheel and not the supporting wheel).
3. Repeat steps 1 and 2 for all supporting wheels.
4. Add the noise ( $L_{Aeq}$  and third-octave band levels) coming from all supporting wheels on energy basis to obtain the overall contribution of supporting wheels on test results for given speed.
5. Compare the results obtained in step 4 with typical tyre/road noise measurements on a similar surface. If the S/N ratio is above 15 dB the influence of the supporting wheels is negligible.

The suggested certification procedure using the “*indirect*” method is as follows:

<sup>17</sup> The “basic” wheels of a self-powered vehicle refer to all wheel excepts the CPX test wheel

1. Mount the microphones close to the supporting wheels (30 - 50 cm) in the direction of the test wheel. In the case of self-powered test vehicles the "basic" wheels should be treated as supporting wheels according to this procedure.
2. Perform CPX measurements for speed 50, 70 and 90 km/h and measure noise ( $L_{Aeq}$  and spectra from 315 - 4000 Hz) with the microphones close to the supporting wheel.
3. Repeat steps 1 and 2 for all remaining supporting wheels if not measured simultaneously.
4. Recalculate the noise recorded close to the supporting wheels to the real distance between the supporting wheels and the CPX test microphones in their "standard" positions (using the distance law or, preferably, the measured or calculated propagation filter).
5. Add the recalculated noise levels ( $L_{Aeq}$  and third-octave band levels) coming from all of the supporting wheels on energy basis to obtain the overall contribution of the supporting wheels on the test results for a given speed.
6. Compare the results obtained in step 5 with typical tyre/road noise measurements on a similar surface. If the S/N ratio is above 15 dB the influence of the supporting wheels is negligible.

**Note:** If there are technical problems in mounting the microphones close to the supporting wheel(s) it is also possible to test the noise of the supporting wheels by mounting the supporting tyres as "test tyres" on the CPX vehicle and then adjusting the microphone positions and the tyre load in such a way that the test conditions simulate the rolling conditions of the supporting wheels.

The "direct" method is strongly preferred in comparison to the "indirect" method and should be used whenever the *"Lifted/Removed Tyre Method"* cannot be applied. The "indirect" method can only be used if vehicle elements around the supporting wheels do not influence the result by either reflecting noise or generating air turbulence noise. In the case of efficient noise screening by the enclosure, the "indirect" method may give a severe overestimation of the noise contributed by the supporting wheels.

### B.1.3 Determination of towing vehicle noise

In most cases noise from the towing vehicle is not a problem during typical CPX measurements provided that the vehicle is in good technical condition. The main sources of towing vehicle noise may be exhaust noise and car tyre/road noise.

The suggested certification procedure is as follows:

1. If the CPX trailer is not a self-powered vehicle then connect the trailer to the towing vehicle. Start the engine and adjust the engine speed to the value typical for CPX test.
2. Measure the noise ( $L_{Aeq}$  and spectra from 315 - 4000 Hz) at the standard microphone positions.

3. Measure (using the CPX method) the tyre/road noise of the towing car tyres or, in the case of self-powered vehicles, the “basic” tyres. Note! Do not use the “standard” microphone positions for these measurements but use microphone positions corresponding to the direction of the test wheel as seen from the position of the supporting or the basic wheel in question.
4. Recalculate the noise measured in step 3 to the real distance between the wheels of the towing car (or the basic wheels of the self-powered vehicle) and the CPX test microphones in their “standard” positions (using the distance law or, preferably, the measured or calculated propagation filter).
5. Add the recalculated noise levels ( $L_{Aeq}$  and third-octave band levels) coming from the rear wheels of the towing vehicle (or all basic wheels of the self-powered vehicle) and the noise of its exhaust system (measured in point on an energy basis) to obtain the overall contribution of the towing car on the test results for a given speed.
6. Compare the results obtained in step 5 with typical tyre/road noise measurements. If the S/N ratio is above 15 dB then the influence of the towing vehicle (or self-powered vehicle) is negligible.

#### B.1.4 Determination of the noise influence of passing vehicles

One of the great advantages of CPX method is its ability to measure tyre/road noise in relatively dense traffic. This means that the test vehicle may be passed or overtaken by other vehicles. Since the noise from these vehicles may reach the CPX microphones and influence the results, it is therefore important to determine the screening quality of the test wheel enclosure (if an enclosure is used) and estimate noise levels related to the passage of other vehicles. Such measurements may be carried out in a relatively simple way using random vehicles on the road as noise sources.

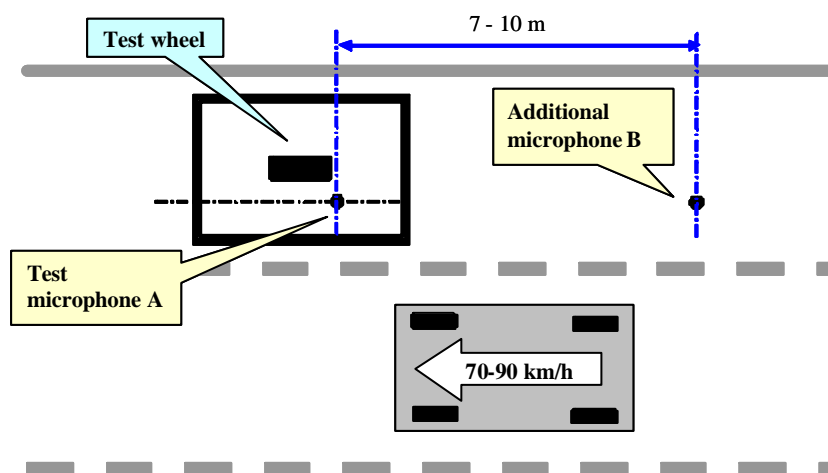

Figure B.2: Set up for determining the influence of other cars passing by the test vehicle

The suggested procedure is as follows:

1. Position the CPX test vehicle on the road-side or in the nearside traffic lane.
2. Mount microphone "A" inside the enclosure at the standard rear microphone position (Figure B.2).
3. Mount microphone "B" outside the enclosure as shown in Figure B.2.
4. Make at least 20 measurements of the maximum noise (including spectra) of passing cars. Cars should be passing-by with a speed of 70-90 km/h
5. Subtract the noise spectra recorded by microphone "A" from the spectra recorded by microphone "B". The averaged difference shows the insulation properties of the chamber for disturbing noise sources that are typical for CPX tests.
6. Compare the averaged spectra obtained at the microphone position "A" with the sound spectra at the rear microphone position for CPX tyre A. The spectra for tyre A should be obtained on SMA or asphalt concrete surface at speeds 30, 50, 70, 80 and 90 km/h.
7. Find the spectrum (among different speeds) for tyre A that is at least 10 dB above the averaged spectrum for microphone "A".
8. For test speeds higher or equal to the speed related to the spectrum selected in item 7 then the influence of passing vehicles is negligible. For lower speeds it is recommended to repeat the measurements, unless the time of influence was very short (less than 10% of total measuring time).

### **B.1.5 Determination of the influence of reflections**

One of the most important issues for the accuracy of CPX measurements is the reduction of noise reflections in the vicinity of the test wheel and test microphones. Most CPX vehicles/trailers utilize protective chambers/enclosures around the test wheel(s) and microphones. These enclosures help to screen extraneous noise from passing traffic and therefore help to isolate the noise from the test tyre. However, the enclosure can reflect noise back to the test microphones unless care is taken to treat the internal surfaces of the enclosure with acoustically absorbent materials

It is considered that the best way to estimate the influence of acoustical reflections on the tyre/road noise measured with the CPX method is to perform and compare tests under "standard" and "ideal" (i.e. in the absence of any reflections) conditions.

The suggested certification procedure when using a drum facility is as follows:

1. Position the CPX Test Vehicle on the drum facility in such a way that the test wheel runs on the drum covered with replica road surface.
2. Make measurements (LA and spectra 315 - 4000 Hz) at speed 80 km/h.
3. Remove or cover with thick layers of absorbing material all reflective surfaces that are close to the tyre and microphone (best of all remove whole chamber and

replace it with very thick absorbing plates) and ascertain that the tyre load is exactly the same like before.

4. Repeat measurements at speed 80 km/h.
5. Compare measurements from steps 4 and 2. Any resulting differences between the two results can be assumed to be caused by reflections inside the chamber.
6. The differences calculated in step 5 should not exceed 3 dB within the frequency range of 315 to 4000 Hz and 1 dB for A-weighted SPL.

The suggested certification procedure when using an artificial noise source (preferably of a sort similar to the artificial wheel sources developed by either M+P or TUG [170]) is as follows:

1. Position the CPX Test Vehicle on the flat, reflective surface and instead of test wheel install an artificial noise source that has geometrical shape similar to the typical car wheel and noise properties concerning directivity pattern corresponding as much as possible to the typical tyre/road noise source.
2. Make measurements (LA and spectra 315 - 4000 Hz) using the artificial noise source and "standard" CPX microphone positions.
3. Remove the artificial noise source and test its noise characteristics in the free-field using exactly the same microphone location like in step 2.
4. Compare measurements from step 3 and 2. Any resulting differences between the two results can be assumed to be caused by reflections inside the chamber.
5. The differences calculated in step 4 should not exceed 3 dB within the frequency range of 315 to 4000 Hz and 1 dB for A-weighted SPL.

*The following important points should be noted for either method:*

The absorbing material used in the CPX test vehicle should be very dry. It has been demonstrated elsewhere that water accumulated in deep part of the material may not be perceptible from outside but still may influence the results considerably.

Due to this fact, neither the certification procedure nor the standard CPX test should be performed if the CPX vehicle is wet or damp.

### **B.1.6 Certification of speed measurement apparatus**

The speed measuring equipment used on/with CPX vehicles should be tested annually by comparing the readings with a calibrated radar, laser device or photo-optic device. If the system is dependent on wheel rotation, the calibration must be repeated when the tyre on the measuring wheel is changed, the load on the wheel changes by more than 10% relative to the calibration conditions or the inflation pressure changes by 10% or greater.

### **B.1.7 Checking the position of the measurement microphones**

Microphone positions should be tested prior to each measurement (that is at the beginning of the measurement session and after each tyre exchange). For test-vehicle, it should be checked with a similar load as in operating conditions: equipment and operators on board. Microphone positions should be tested with gauge and adjusted according to the standard. It is recommended to use specialized gauge that is based on the undeflected sidewall of the test tyre and has arms showing proper microphone positions. The gauge should be constructed in such a way, that its geometrical dimensions are stable over time.

## **B.2 SPB measurement apparatus**

All requirements related to the instruments used during Statistical Pass-By (SPB) measurements are documented in Chapter 5 of the standard ISO 11819-1 [26]. There is no need to introduce any new procedures in this respect.

## **B.3 Absorption measurement apparatus**

The following certification procedures are applicable to systems for carrying out measurements of the acoustic performance of road surfaces in-situ using the “Extended Surface Method” as described in ISO 13472-1 [115].

The mounting frame connecting the loudspeaker to the microphone should be certified before the remainder of the supporting structure. The certification procedures set out in the following text are applied under static conditions but are applicable to *both* static and dynamic<sup>18</sup> systems. It is not considered feasible to certify dynamic systems under dynamic operation.

Care must be taken in the selection of the surface to be used for the certification procedure. Ideally, the surface should have relatively low absorption to maximise any reflection effects, although it should be sufficient to select a surface that would be expected to have lower absorption properties over the full frequency spectra than the road surfaces on which the method would normally be applied.

### **B.3.1 Stage 1 - Certification of the frame connecting the microphone with the loudspeaker**

Since the method set out in ISO 13472-1 is based upon the *signal subtraction technique*, it is recommended that the loudspeaker and microphone used for absorption measurements should be physically connected to ensure that the separation of the two remains constant (as far as is possible) as the orientation is changed for measurement of the free-field and combined direct/reflected impulse response components (pointing

---

<sup>18</sup> A dynamic absorption measurement is defined as one where the apparatus is moving along the test surface as the measurement is being taken (see for example Morgan and Watts (2003))

towards and away from the road surface respectively). The physical connections, referred to in the following text as the “*microphone support frame*”, should have as small a cross-section as possible to minimise contributions to the received signal from reflections off of the frame. Due to these reflections, the type of support used may influence the length of time window that can be used for the analysis of the measurement data and consequently the lowest usable frequency.

It is recommended that the influence of the microphone support frame should be examined by performing two full measurements on the chosen certification surface: one with the loudspeaker and microphone connected together by the mounting frame and one where the microphone is supported independently of the loudspeaker. In the latter case, the microphone should be supported between thin wires so that at the same time, reflections from the microphone holder itself can also be eliminated. The set-ups for these measurements are shown in Figure B.3. In Figure B.3(a) the set-up including the microphone support frame is shown, Figure B.3(b) shows the set-up without the support frame. In all cases, the test area should be free of any reflective surfaces that might result in the unwanted reflections within the measurement time window.

The method used for supporting the loudspeaker for these certification measurements will depend upon the facilities available where the apparatus is being certified. As shown in Figure B.3(b), the loudspeaker should either be suspended from a hoist or in between two tripods (where the separation from the loudspeaker and microphone is sufficient to ensure any reflections are outside of the required time window). This may also affect the approach used for the free-field measurements: this should either be performed with the loudspeaker oriented vertically downwards, the microphone and loudspeaker being at such a height that the reflected signal from the ground/reference surface arrives outside of the selected time window, or with the loudspeaker and microphone oriented in the horizontal plane at least 2.0 m above the ground (this could be done with the loudspeaker mounted on a single tripod).

1. A comparison of the absorption spectra with and without the mounting frame should be made, based upon the frequency interval determined by the time window or at one-third-octave band centre frequencies depending upon the output from the measurement system. At each frequency, the difference between the absorption coefficients with and without the frame should be less than 0.05 for the frame to be deemed as not contributing significantly to the windowed time signal.
2. If the differences are significantly outside the allowed tolerance, it will be necessary to modify the support frame to eliminate the unwanted reflections, either for example by changing the design, material dimensions, or by applying some form of sound absorptive treatment.

### **B.3.2 Stage 2: The main loudspeaker/microphone system support structure**

The intended use of the measurement system, i.e. whether the system will be used for static or dynamic measurements, is also likely to affect the way in which the loudspeaker/microphone system is supported; a more significant structure will be required if the system is to be used under dynamic conditions so as to reduce vibration and swing/bounce of the components. Whatever the mounting arrangement, it is important to check that no significant reflections from the supporting structure occur within the time window to be used in the analysis of the signals.



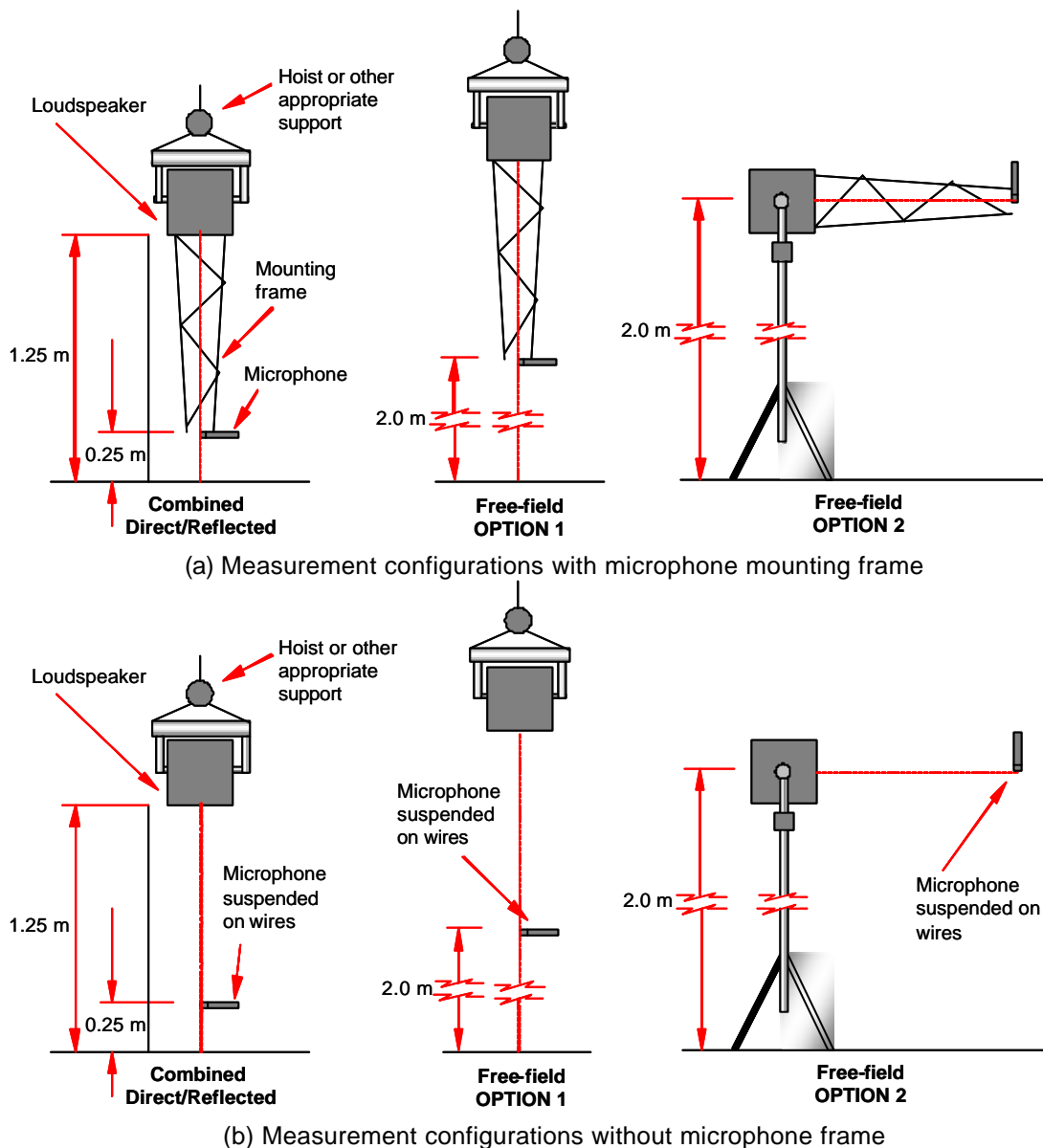

Figure B.3: Measurement set-ups for certifying microphone support frame

In the simplest of situations for static measurements, the loudspeaker/microphone system might be simply suspended, for example, between two tripods. In such a case, it may be sufficient to look at the basic geometry to ensure that any possible reflections would arrive at the microphone outside of the required time window.

For those systems where the support structure is in close proximity to the loudspeaker or where the support structure is more complex, for example as on the trailer system tested by Morgan and Watts [172], it is recommended that the influence of the microphone support frame should be examined by performing two full measurements on the selected certification surface: one with the loudspeaker/microphone suspended from the support structure and one where the loudspeaker/microphone are supported in the absence of the support structure.

The recommended set-ups for these measurements are shown in Figure B.4 (the support structure shown in the figure is a trailer-type structure for dynamic measurements, but the same principles apply for testing simpler support structures). In Figure B.4(a) the measurement setup with the support structure is shown; Figure B.4(b) shows the setup without the support structure. It is noted that this is the same set-up as that in the Stage 1 calibration including the microphone support frame. If the Stage 1 measurements have successfully certified the support frame, then the Stage 2 certification can be carried out during the same measurement session. If the two certification stages are not performed during the same measurement session, then the measurements with only the microphone support structure should be repeated during the Stage 2 certification.

In all cases, the test area should be free of any reflective surfaces that might result in the unwanted reflections within the measurement time window.

The method used for supporting the loudspeaker/microphone system for the measurements in the absence of the main support structure will depend upon the facilities available where the apparatus is being certified. As shown in Figure B.4(b) the loudspeaker should either be suspended from a hoist or in between two tripods (where the separation from the loudspeaker and microphone is sufficient to ensure any reflections are outside of the required time window). The free-field measurements should either be performed with the loudspeaker oriented vertically downwards, the microphone and loudspeaker being at such a height that the reflected signal from the ground arrives outside of the selected time window, or with the loudspeaker and microphone oriented in the horizontal plane at least 2.0 m above the ground (this could be done with the loudspeaker mounted on a single tripod).

1. A comparison of the absorption spectra with and without the support structure should be made, based upon the frequency interval determined by the time window or at one-third-octave band centre frequencies depending upon the output from the measurement system. At each frequency, the difference between the absorption coefficients should be less than 0.05 for the support structure to be deemed as not contributing significantly to the windowed time signal.
2. If the differences are significantly outside the allowed tolerance, it will be necessary to modify the support structure to eliminate the unwanted reflections, either for example by changing the design or material dimensions (this will obviously depend upon the complexity of the structure), or by applying some form of sound absorptive treatment.

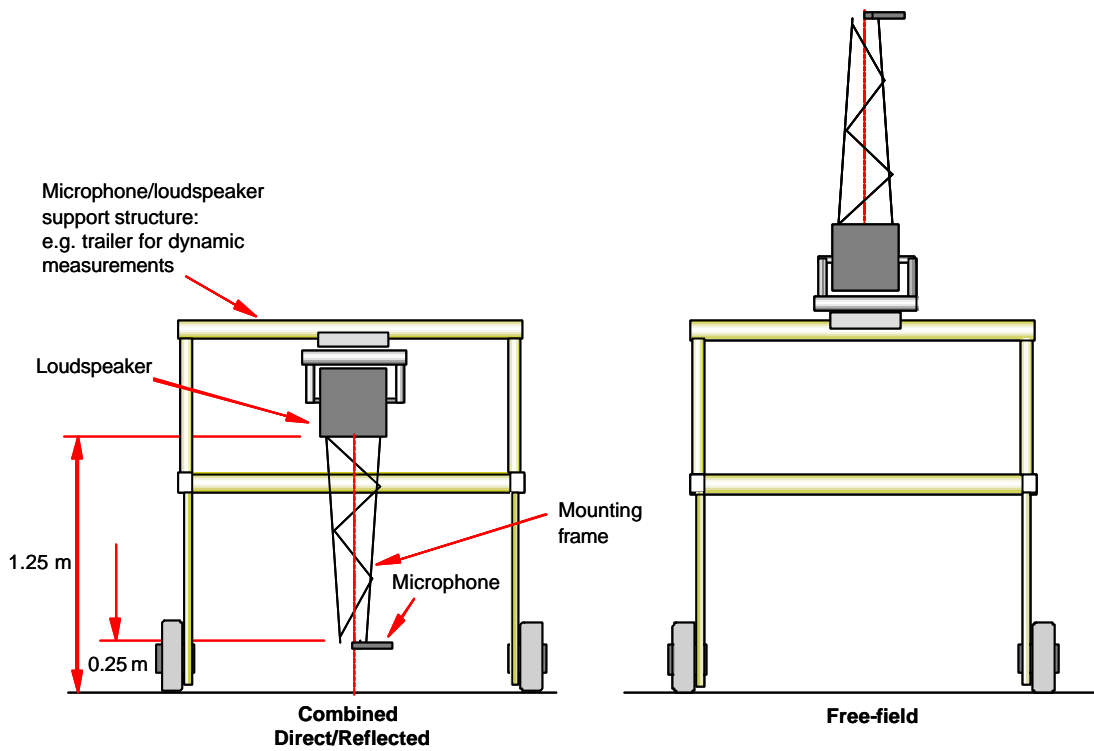

(a) Measurement configurations with support structure

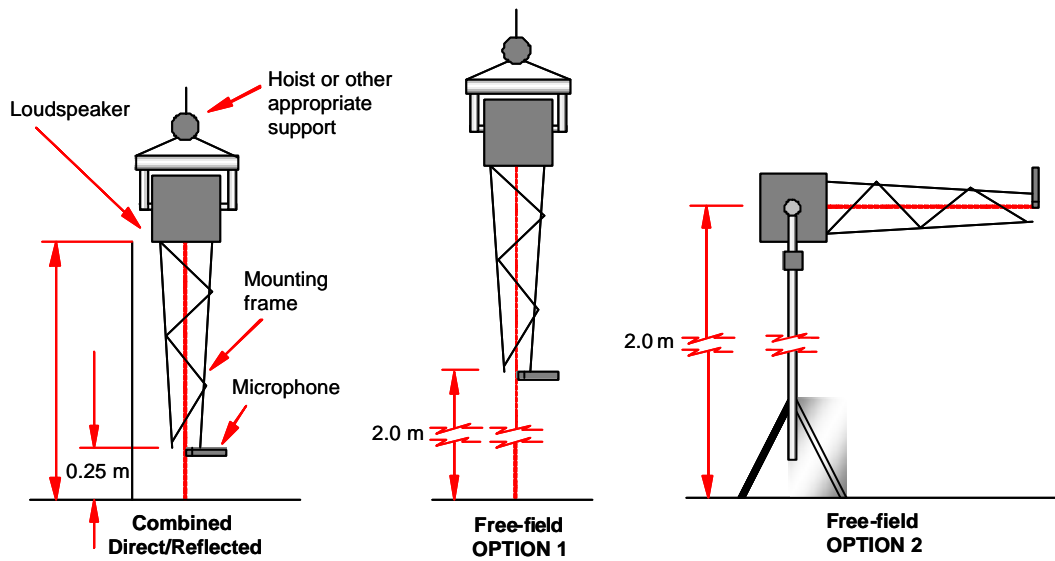

(b) Measurement configurations without support structure

Figure B.4: Measurement set-ups for certifying main support structure

## B.4 Surface texture equipment

### B.4.1 Compliance with regulations for equipment standards

Texture measuring equipment is specified in ISO 13473-3 [119]. In this application, two cases can be distinguished:

- Measurement of Mean Profile Depth (MPD) is sufficient – see ISO 13473-1 [117];
- Measurements must include the analysis of texture in texture spectral bands – see ISO 13473-2 [118].

In both cases, the profilometer shall meet the requirements of ISO 13473-3 as follows:

- Wavelength Range Class DE (Table 2 of ISO 13473-3).

From this, all other requirements, such as horizontal and vertical resolution, bandwidth, background noise, linearity, etc, in ISO 13473-3 follow.

Certification of equipment shall rely on conducting tests relevant to the requirements of ISO 13473-3 and certifying that the results meet the requirements of a profilometer of Wavelength Class DE (or a wider range, if applicable).

The tests are recommended to be made by a nationally approved test agency in the country (such as TÜV in Germany and SP in Sweden), but may also be made by the producer of the equipment. In the former case, it is sufficient if the results are recorded and made publicly available. In the latter case, all test procedures as well as the test results shall be clearly described in a publicly available document.

### B.4.2 System calibration

Before a measurement of texture is made, and preferably also after it (this could include a number of measurements in a series of tests during the same day), the equipment shall be calibrated. It is recommended that this calibration follows the principles outlined in Annex A of ISO 13473-3. This relies on rotating a well known profile produced on a circular disc under the profilometer. If this rotation speed is chosen to give a speed which is similar to the ordinary measuring speed of the profilometer, the texture wavelength scales are directly comparable.

If only the profile is measured, it may be most practical to use a calibration surface of rectangular type, as outlined as the second option in Annex A of ISO 13473-3.

If the texture spectrum is evaluated, it is recommended to use a triangular profile with a 20 mm periodicity and 10 mm peak-bottom amplitude, as outlined as the first option in Annex A of ISO 13473-3. Calibration shall then NOT consider the peak and bottom parts of the triangular wave, but the RMS value of the fundamental component (at 20 mm texture wavelength). Adjusting the profilometer output to an RMS reading fitting the theoretical RMS of this fundamental component, will give the best calibration. With regard to the

texture wavelength spectrum, checking the RMS values of the harmonics and comparing them with theoretically calculated values for a triangular wave, as well as the wavelengths of these harmonics, will provide a fair estimation of the frequency response and the spatial frequency scale of the profilometer system.



## Appendix C. SILVIA proposals for a classification scheme

### C.1 Introduction

The acoustic performance of road surfaces is presently assessed differently in the individual Member States of the EU, making it difficult for suppliers to operate in markets outside their own country. The provision of a harmonised classification system for road surfaces will help to overcome this problem and also assist other stakeholders and parties responsible for road networks.

This Appendix describes in detail proposals for a classification system for the acoustic labelling of low-noise surfaces. The system has been designed, as far as possible, to provide outputs that are compatible with existing national and future EU noise prediction models and existing classification systems.

The following key points should be noted:

- This system is only a *proposal* and should not be interpreted as being legislative or in any way mandatory;
- The procedures and methods described are considered by the SILVIA consortium as being *the preferred approach*, but these may be modified or adapted by the relevant users or contracting parties as considered necessary (e.g. performing fewer measurements, considering fewer vehicle categories, etc.). However, *it must be clearly stated in the label information* for the surface type where deviations from the recommended procedure have taken place to avoid uncertainty;
- The SILVIA classification system addresses acoustic labelling, COP assessment and routine/periodic monitoring and uses, wherever possible, standard measurement methods and practices. As such, the ISO standards etc, cited in these procedures are the versions *that were available when the procedures were written*. However, it is recommended that the versions of the Standards used when actually applying the classification system are those *that are in current circulation* when the classification system is applied;
- The labelling and COP procedures described have not been assessed in practice due to the timescale for development of the classification system within the SILVIA project. *It is therefore recommended that care be exercised when following these procedures;*
- It should also be noted, that the tolerances specified in the procedures are based on the expert judgement of the SILVIA consortium at the time of writing and have not been fully validated by field trials. Experience gained in applying the described procedures and carrying out the acoustic labelling of road surfaces will help to refine the tolerances that have been recommended in this manual.

## C.2 Labelling procedures

The acoustic labelling procedure described in this proposal is based around the assessment of trial sections of road surface that will most likely have been laid specifically for the purposes of acoustic labelling (i.e. to ensure as a high and consistent a quality as possible over the test length).

The following terminology is used in the labelling procedures defined within this section:

- *Trial length*: Total length of road from which trial section will be selected for use in the labelling procedure;
- *Trial section*: A section of the trial length that will be used for defining the acoustic label;
- *Trial segment*: A 20 m segment of the trial length identified as the length over which a CPX Index value is averaged.

A minimum length of 100 m is required for a trial length, not including the first 20 m after the paving operation commences, since the homogeneity of the surface over that part cannot be guaranteed.

It is also recommended that a trial length is not longer than 1000 m, which is a sufficient distance to demonstrate that the surface can be laid homogeneously. If the trial length is very long, say several km, then the requirements for trial length suitability defined in the following sections might eliminate sites where a sufficiently long length of homogenous test section might be readily identified.

As described in Chapter 9 of this Guidance Manual, there are two levels of label that can be determined for the acoustic labelling of a low-noise road surface and these are based on different measurements as follows:

- *LABEL1* (preferred): Assessment based on SPB and CPX measurements;
- *LABEL2*: Assessment based on SPB measurements and the measurements of intrinsic properties of the road surface, e.g. texture and, where relevant, acoustic absorption and mechanical impedance.

*LABEL1* is the preferred choice of label since the associated measurements provide a direct assessment of noise over the full trial length. This in turn means that there are fewer assumptions made with regard to the homogeneity of the surface.

The labelling procedures outlined here have not been assessed in practice due to the timescale for the development of the classification system within the SILVIA project. It is therefore recommended that care be exercised when following these procedures and that the recommended tolerances might require adjustment in the light of practical experience.



### C.2.1 Procedure for determining LABEL1 values

The procedure for determining LABEL1 values is based on performing SPB and CPX measurements.

SPB measurements should be performed in accordance with ISO 11819-1 [26]. CPX measurements should be carried out using the *investigative method* (4 tyres) in accordance with draft ISO 11819-2 [113]. Further information on these measurement methods is included in Appendix A of this Guidance Manual.

The measurements are performed using the site layout shown in Figure C.1. For illustrative purposes, it is assumed that the trial section for acoustic labelling is 100 m long.

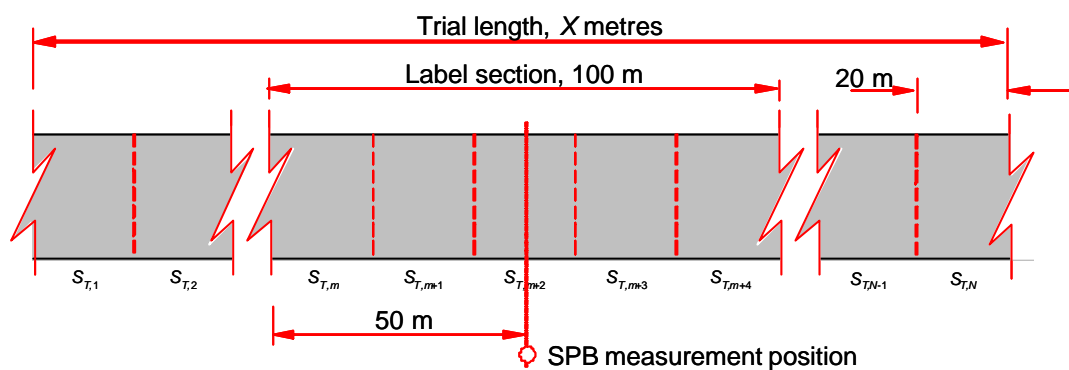

Figure C.1: Site layout for SPB and CPX measurements to determine LABEL1 values

The procedure is shown schematically as a flowchart in Figure C.2; the details of each stage of the procedure are as follows:

**STAGE 1:** Select an appropriate  $X$  m long trial length of the surface to be labelled. Ideally this will have been laid specifically for the purposes of acoustic labelling.

**STAGE 2:** Carry out CPX measurements along the whole length of the  $X$  m long trial length. The trial length is divided into  $N$ , 20 m, trial segments,  $S_{T,1}, S_{T,2}, \dots, S_{T,N}$ <sup>19</sup>. A minimum of ten measurements is required, so that if the trial length is less than 200 m, the segments must be measured twice.

**STAGE 3:** Determine the CPX Index for each individual 20 m segment, i.e.  $CPXI_{S_{T,n}}$   $n = 1, 2, \dots, N$ . Also, determine the average CPX Index,  $CPXI_{Average}$ , over the whole  $X$  m of the trial site (or 200 m whichever is the shorter). This is calculated simply as the mean of the CPXI indices for each of the 20 m segments.

<sup>19</sup> The subscript T denotes that this is a segment at trial location, T.

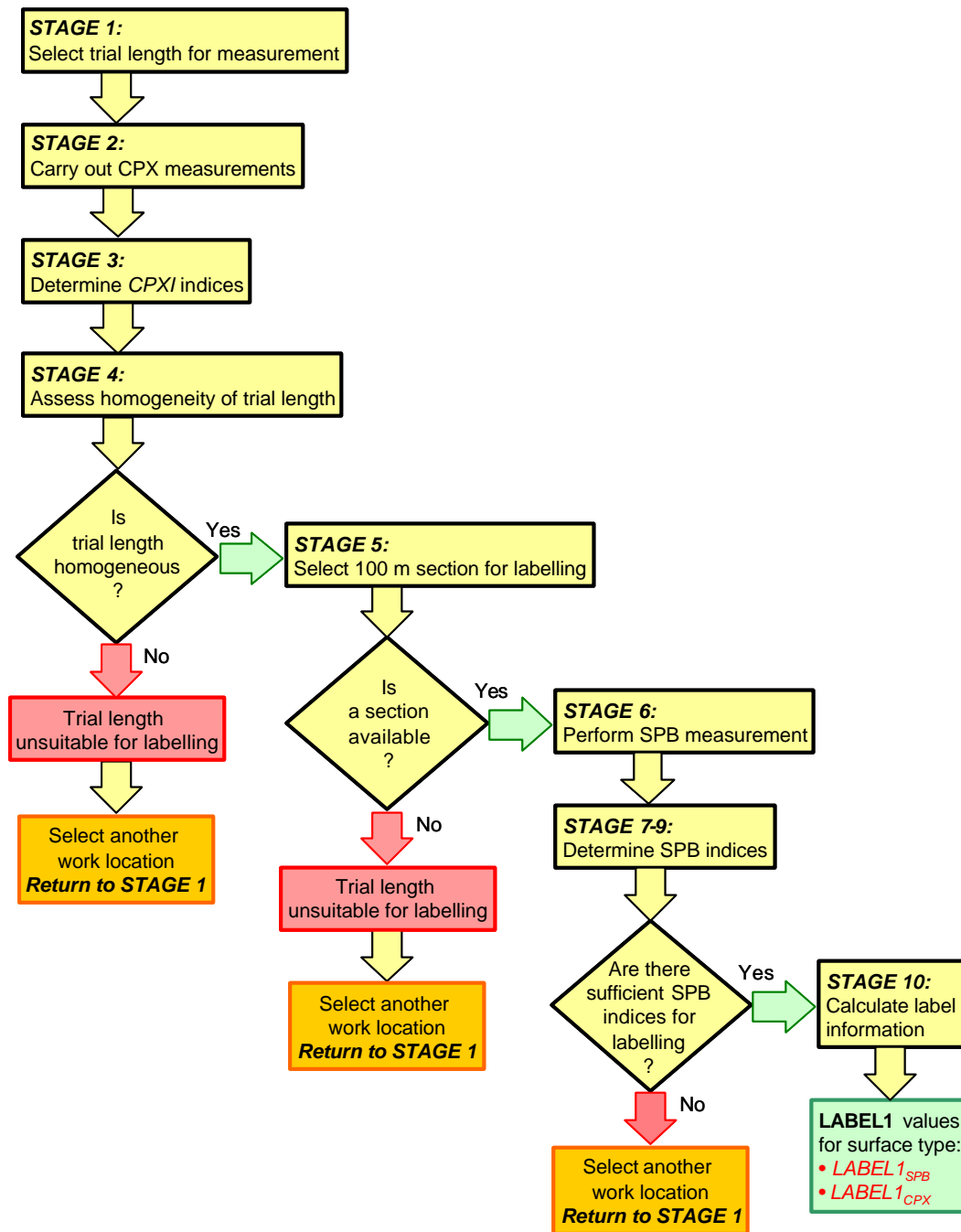

Figure C.2: Flowchart showing procedure for determining LABEL1 values at a single site

**STAGE 4:** Determine the degree of homogeneity of the whole trial length by determining if the CPX Index for each 20 m segment,  $CPXI_{ST,n}$ ,  $n = 1, 2, \dots, N$ , falls within the tolerance defined in Table C.1, i.e. 0.5 dB(A) peak-to-peak of the average CPX Index for the whole section,  $CPXI_{Average}$ .

Table C.1: Tolerances for acceptance of trial length (LABEL1 parameters)

Measurement type	Homogeneity Indicator	Tolerance limit	Tolerance requirement	Segment Length
CPX (Investigative method)	CPXI	0.5 dB(A) peak-to-peak around mean value	90% of 20 m segments to be within tolerance	20 m

The tolerance requirements specified in Table C.1 are based on the expert judgement of the SILVIA consortium at the time of writing and *have not been fully validated by field trials*. It is likely that these tolerances will be revised at some point in the future following experience with applying the classification system.

If more than 10% of the CPXI indices fall outside of this tolerance, then the trial length is defined as being unsuitable for labelling and a new trial length will be required for the surface type to be labelled.

If the trial length is confirmed as being sufficiently homogeneous for labelling purposes, then the procedure continues to Stage 5.

**STAGE 5:** Having established that the whole trial length is sufficiently homogeneous, it is necessary to select a 100 m length section within the trial length that is suitable for the derivation of the label parameters. For a label section to be suitable, it must satisfy the following stricter criteria:

- Each of the five 20 m segments,  $S_{T,m}$ ,  $S_{T,m+1}$ , ...,  $S_{T,m+4}$ , must have a corresponding CPXI value that falls within the tolerance defined in Table C.2, i.e. within 0.5 dB(A) peak-to-peak of the average CPX Index for the trial length;
- The site should be suitable for performing an SPB measurement, conforming to the requirements stated in the ISO standard 11819-1.

If a suitable 100 m section cannot be identified within the trial length, then the trial length is defined as being unsuitable for labelling. A new trial length will therefore be required for the surface type to be labelled.

If a 100 m section can be identified, then the procedure continues to Stage 6.

Table C.2: Tolerances for acceptance of 100 m label section (LABEL1 parameters)

Measurement type	Homogeneity Indicator	Tolerance limit	Tolerance requirement	Segment Length
CPX (Investigative method)	CPXI	0.5 dB(A) peak-to-peak around mean value	All 20 m segments to be within tolerance	20 m

The tolerance requirements specified in Table C.2 are based on the expert judgement of the SILVIA consortium at the time of writing and *have not been fully validated by field trials*. It is likely that these tolerances will be revised at some point in the future following experience with applying the classification system.

**STAGE 6:** Carry out an SPB measurement midway along the selected 100 m section within the trial length, as described in Section A.1 of Appendix A, for each vehicle category to be considered in the label.

**STAGE 7:** Determine the valid speed range for each vehicle category,  $m$  as described in Section A.1.1 of Appendix A.

**STAGE 8:** For each vehicle category  $m$ , calculate  $L_{Amax,m}$  at each 10 km/h interval within the valid speed range (see Section A.1.1 of Appendix A).

**STAGE 9:** For each vehicle category, select an appropriate reference speed for which the label will be defined. Determine the  $L_{Amax,m,vref}$  level for each vehicle category at the defined reference speed,  $v_{ref}$  km/h, (see Section A.1.2 of Appendix A).

To reduce the influence of different aggregate types and variations in the laying process, a number of  $L_{Amax,m,vref}$  values at different trial locations should be obtained. At this stage it needs to be established whether, for each vehicle category, there is the required number of  $L_{Amax,m,vref}$  values for labelling. For the purposes of labelling at one reference speed, then at least two  $L_{Amax,m,vref}$  values at that reference speed is required for each vehicle category, as illustrated in Table A.3 of Appendix A. For the purposes of deriving a generic relationship between  $L_{Amax,m,vref}$  and speed,  $v_{ref}$ , this procedure should ideally be repeated for at least five different trial sites, as illustrated in Figure A.2 of Appendix A. If there are insufficient values for labelling, a new trial length should be selected and assessed according to the above procedure.

If there is the required number of  $L_{Amax,m,vref}$  values for labelling, then the procedure continues to Stage 10.

**STAGE 10:** Determine the corresponding label values for the surface type under study as follows:

- **$LABEL1_{SPB}$**  Calculate the average  $L_{Amax,m,vref}$  values from each trial length for each vehicle category,  $m$ , at the appropriate reference speed,  $v_{ref}$  km/h as described in Section A.1.2 of Appendix A. The corresponding normalised octave spectra should also be recorded as described in Section A.1.3 of Appendix A;
- **$LABEL1_{CPX}$**  Calculate the average CPXI value from all trial lengths. For each 100 m trial length, the average CPXI is calculated from the five CPXI values recorded on each 20 m section.

### C.2.2 Procedure for determining **LABEL2** values

The procedure for determining **LABEL2** values is based on performing an SPB measurement together with measurements of some intrinsic properties of the road surface that are known to affect the acoustic performance. For dense, non-absorptive road

surface the additional measurements required will be some specific measurements of the surface texture. However, if the surface is porous then measurements of the acoustic absorption spectra can be used. Finally for elastic materials a measurement of the mechanical impedance can be used. The additional measures are included, essentially to establish the degree of acoustic homogeneity exhibited by the surface. It should be noted that, the method for assessing the acoustic performance of surfaces using *LABEL2* procedures are implicitly less reliable than the *LABEL1* procedure because of the assumptions that need to be made in relating the non-acoustic measures to acoustic performance.

SPB measurements should be performed in accordance with ISO 11819-1 [26]. Mobile and static texture measurements should be carried out in accordance with ISO 13473-1 [117], ISO 13473-3 [119] and ISO/CD TS 13473-4 [120]. Absorption measurements should be carried out using the Extended Surface Method described in ISO 13472-1 [115]. There is presently no standard method for the measurement of mechanical impedance; a prototype method has been developed as part of the SILVIA project but further research into its application is required. Further information on these measurement methods is included in Appendix A of this Guidance Manual.

The measurements are performed using the site layout shown in Figure C.3 for mobile measurements and Figure C.4 for static measurements. For illustrative purposes, it is assumed that the label section is 100 m long.

In the case of the static measurements, it is recommended that within both the trial length and the label section the first measurement position ( $P_{T,1}$  and  $P_{T,m}$  respectively in Figure C.4) be located 5 m from the left-hand end of the section.

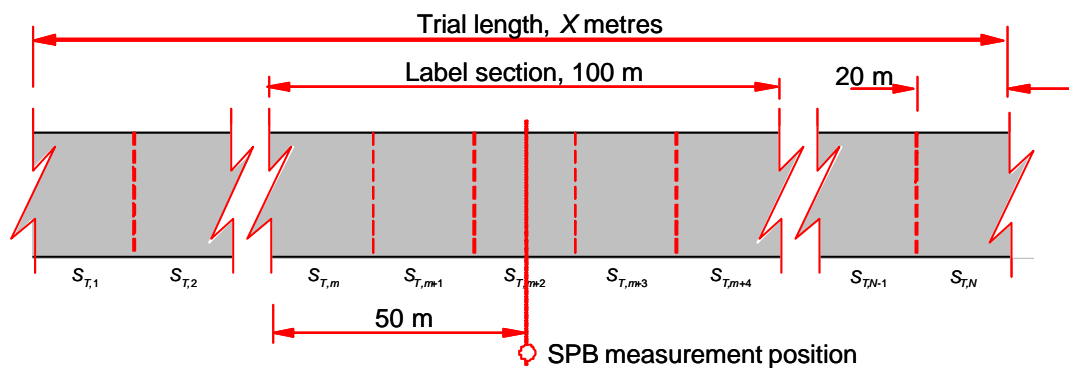

Figure C.3: Site layout for SPB and mobile texture measurements to determine *LABEL2* values

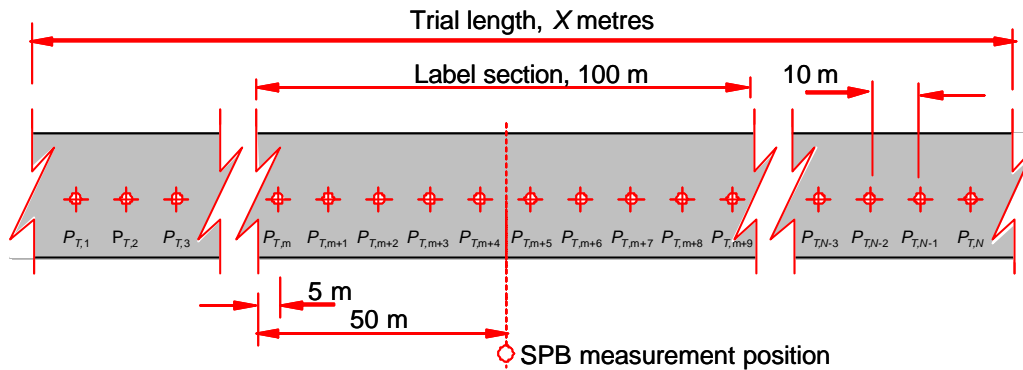

Figure C.4: Site layout for SPB and static measurements to determine LABEL2 values (Measurement positions only shown with respect to distance along length, not with respect to position across the carriageway)

The procedure is shown schematically on the following pages as a flowchart in Figure C.5 and Figure C.6; the details of each stage of the procedure are as follows:

**STAGE 1:** Select an appropriate  $X$  m long trial length of the surface to be labelled. Ideally this will have been laid specifically for the purposes of acoustic labelling.

**STAGE 2:** Carry out a single SPB measurement (for each vehicle category to be considered in the label) at an arbitrarily chosen site within the  $X$  m long trial length. This site should be selected to be visually representative of the whole trial length and conforms to the site requirements stated in the ISO Standard 11819-1.

**STAGE 3:** Determine the valid speed range for each vehicle category,  $m$  as described in Section A.1.1 of Appendix A.

**STAGE 4:** For each vehicle category  $m$ , calculate  $L_{Amax,m}$  at each 10 km/h interval within the valid speed range (see Section A.1.1 of Appendix A).

**STAGE 5:** For each vehicle category, select an appropriate reference speed for which the label will be defined. Determine the  $L_{Amax,m,vref}$  level for each vehicle category at the defined reference speed,  $v_{ref}$  km/h, (see Section A.1.2 of Appendix A).

**STAGE 6:** Determine  $L_{Amax,1,vref,i}$ , the third-octave band noise spectrum derived from the SPB measurement for category 1 vehicles at the reference speed  $v_{ref}$  km/h (the speed to be used in the texture envelopment) as described in Section A.1.3 of Appendix A.

**STAGE 7:** Carry out texture measurements along the whole length of the trial site. The site should be considered as being comprised of either  $N$ , 20 m segments (if mobile texture measurements are being used; a minimum of ten measurements are required, so that if the trial length is less than 200 m, the segments must be measured twice.), or  $N$  spot positions at 10 m intervals (if static texture measurements are being used.)

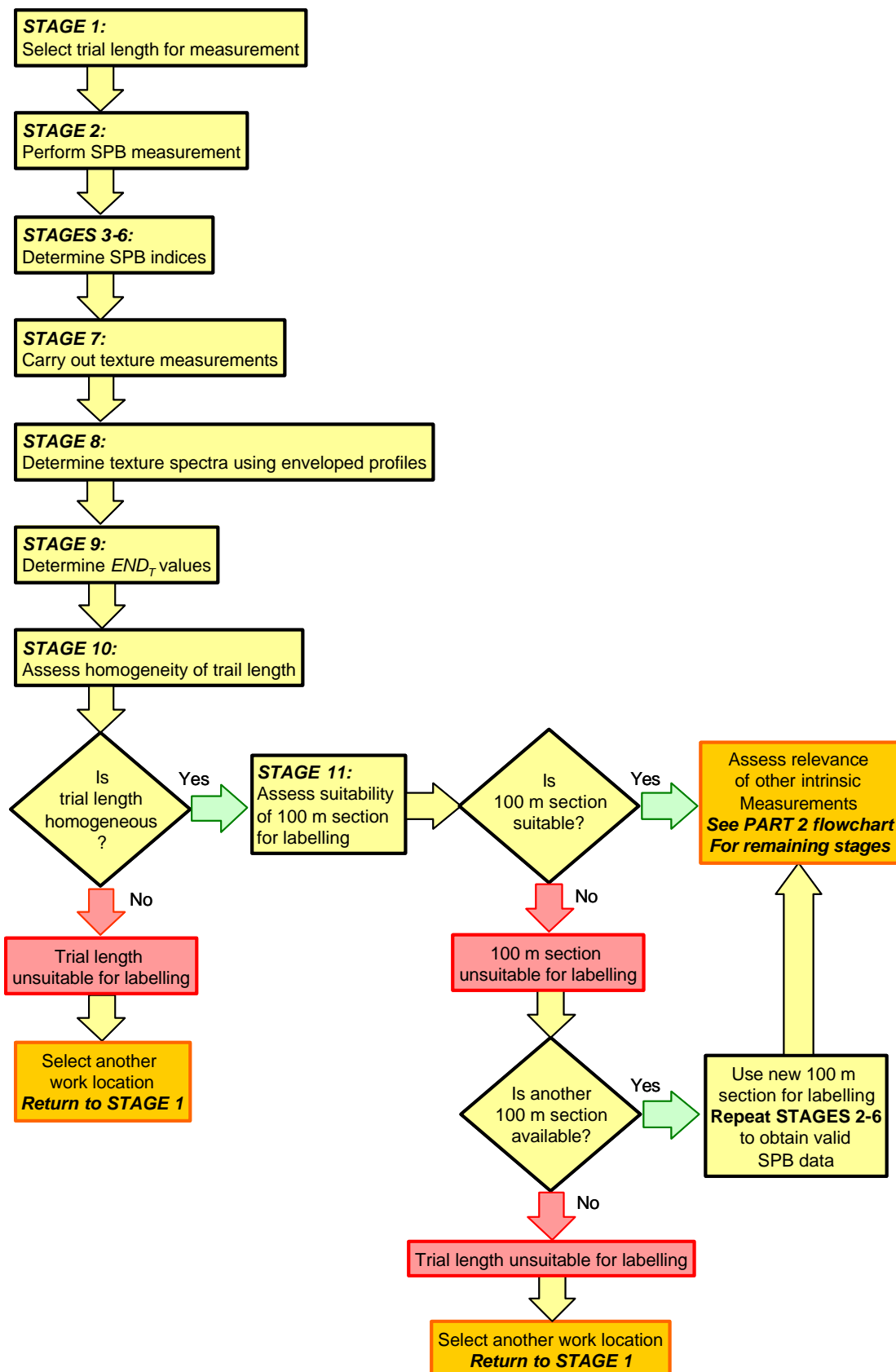

Figure C.5: PART 1 flowchart showing procedure for determining LABEL2 values

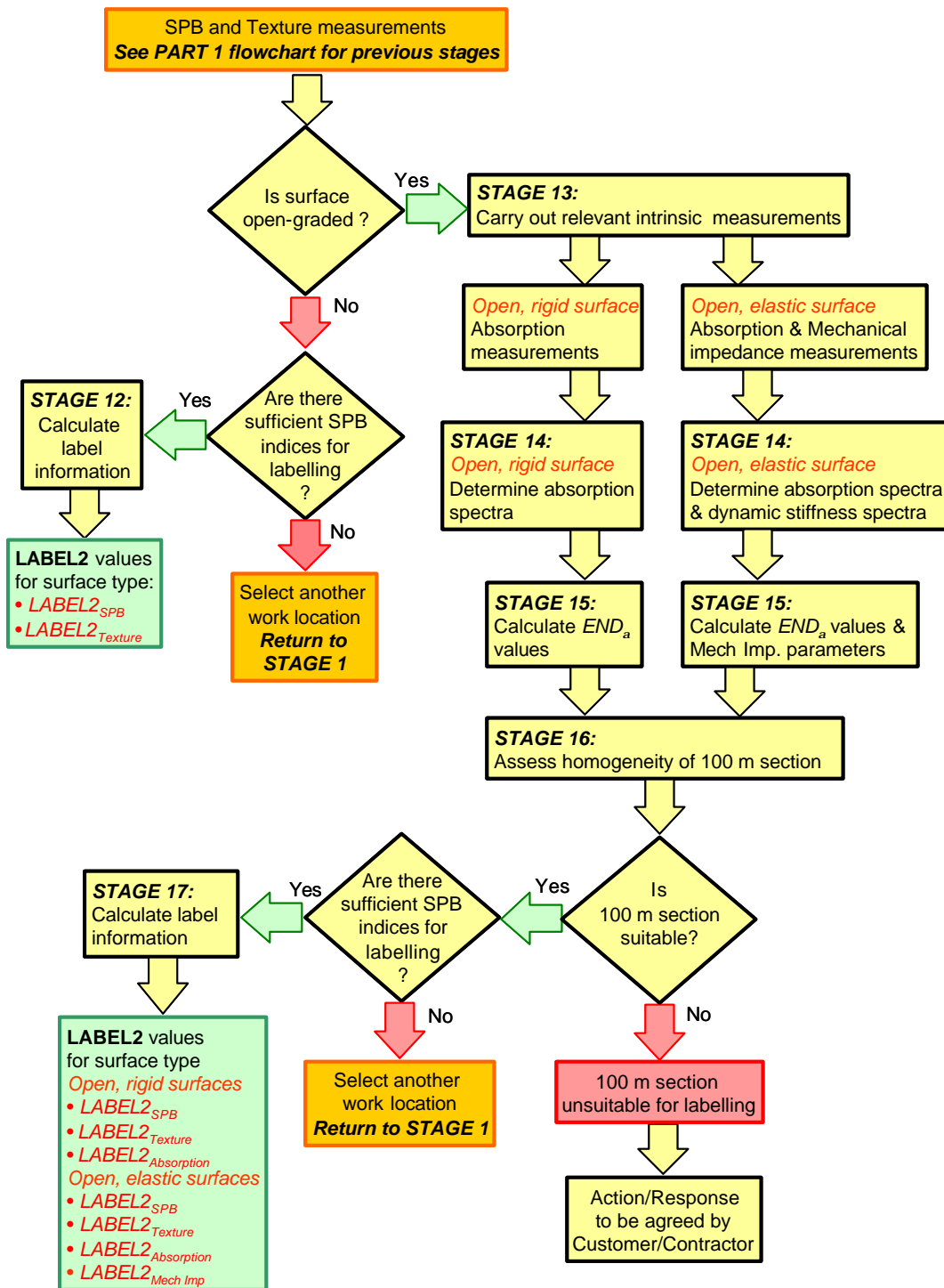

Figure C.6: PART 2 flowchart showing procedure for determining LABEL2 values



**STAGE 8:** Using the enveloped texture profile (envelopment parameter  $E = 1 \text{ MN/m}^2$ , see Section A.4.4), determine the third-octave band texture spectrum given by

- $L_{eT,i,ST,n}$  for each 20 m segment  $S_{T,n}$ ,  $n = 1, 2, \dots, N$  (if using mobile texture measurements), or
- $L_{eT,i,PT,n}$  for each spot position  $P_{T,n}$ ,  $n = 1, 2, \dots, N$  (if using static texture measurements).

Similarly, also determine the average third-octave band texture spectrum  $L_{eT,i,Average}$  over the whole  $X$  m of the trial length. This is calculated by linearly averaging texture levels, dB.

For dense surfaces, an additional parameter is required, the texture level in the 5 mm octave band wavelength for each segment (mobile texture measurements) or at each spot (static texture measurements),  $L_{T,5mm,ST,n}$  or  $L_{T,5mm,PT,n}$ , respectively, together with the average texture level over the trial length,  $L_{T,5mm,Average}$ .

**STAGE 9:** Determine the  $END_T$  (the estimated pass-by noise level difference from texture level variations) for each segment  $S_{T,n}$  or position  $P_{T,n}$  using the equation

$$END_T = 10 \times \log_{10} \frac{\sum_i 10^{(L_{Amax,1,vref,i} + b_i \cdot \Delta L_{eT,i})/10}}{\sum_i 10^{L_{Amax,1,vref,i}/10}} \text{ dB} \quad \text{for open-graded surfaces, or (C.1)}$$

$$END_T = 10 \times \log_{10} \frac{\sum_i 10^{(L_{Amax,1,vref,i} + b_i \cdot \Delta L_{eT,i})/10}}{\sum_i 10^{L_{Amax,1,vref,i}/10}} - 0.25 \Delta L_{T,5mm} \text{ dB for dense surfaces. (C.2)}$$

where

- $L_{Amax,1,vref,i}$  is the third-octave band spectral level in each third-octave band,  $i$ , measured at the maximum pass-by noise level,  $L_{Amax,1,vref}$ , for category 1 vehicles at a reference speed  $v_{ref}$  km/h.
- $\Delta L_{eT,i}$  is the third-octave band enveloped texture level difference in each third-octave band,  $i$ , at a given speed  $v_{ref}$  km/h between the average enveloped texture over the whole of the trial length ( $L_{eT,i,Average}$ ) and the enveloped texture measured for the segment or spot position under consideration ( $L_{eT,i,ST,n}$  or  $L_{eT,i,PT,n}$ ) as determined during Stage 8;
- $b_i$  are the coefficients given in Table C.3,
- $\Delta L_{T,5mm}$  is the texture level difference in the 5 mm wavelength octave band between the average texture over the whole of the trial length ( $L_{T,5mm,Average}$ ) and the enveloped texture measured for the segment or spot position under consideration ( $L_{T,5mm,ST,n}$  or  $L_{T,5mm,PT,n}$ ) as determined during Stage 8;

Table C.3:  $b_i$  coefficients for calculating  $END_T$ 

f (Hz)	250	315	400	500	630	800	1000	1250	1600	2000	2500	3150	4000
$b_i$	0.90	0.85	0.80	0.75	0.70	0.65	0.40	0.0	0.0	0.0	0.0	0.0	0.0

**STAGE 10:** Determine the homogeneity of the whole trial length by determining if the chosen level difference for each 20 m segment or spot position,  $END_{T,ST,n}$  and  $END_{T,PT,n}$  respectively, falls within the tolerance defined in Table C.4, i.e.  $\pm 0.5$  dB.

In the case of the static measurements, the assumption is made that the homogeneity of the surface between measurement spots is consistent and falls within the tolerances specified in Table C.4.

Table C.4: Tolerances for acceptance of trial length (LABEL2 parameters)

Measurement type	Homogeneity Indicator	Tolerance	Tolerance requirement	Segment Length	Spot separation
Texture (Mobile)	$END_T$	$\pm 0.5$ dB(A)	90% of 20 m segments to be within tolerance	20 m	N/A
Texture (Static)	$END_T$	$\pm 0.5$ dB(A)	90% of spot measurements to be within tolerance	N/A	10 m

The tolerance requirements specified in Table C.4 are based on the expert judgement of the SILVIA consortium at the time of writing and *have not been fully validated by field trials*. It is likely that these tolerances will be revised at some point in the future following experience with applying the classification system.

If more than 10% of the measurements fall outside of the specified tolerance, then the trial length is defined as being unsuitable for labelling and a new trial length will be required for the surface type to be labelled.

If the trial length is confirmed as being sufficiently homogeneous for labelling purposes, then the procedure continues to Stage 11.

**STAGE 11:** Having established that the whole trial length is sufficiently homogeneous, it is necessary to assess whether the 100 m section of the road surface that is centred on the SPB measurement position used in Stage 1 (i.e. the 50 m either side of the SPB position) is suitable for the derivation of the label parameters. For the section to be suitable, it must satisfy the following stricter criteria:

- Each of the five 20 m segments or 10 spot positions must have a corresponding  $END_T$  value that falls within the tolerance defined in Table C.5, i.e.  $\pm 0.5$  dB.

Table C.5: Tolerances for acceptance of 100 m label section (LABEL2 parameters)

Measurement type	Homogeneity Indicator	Tolerance	Tolerance requirement	Segment Length	Spot separation
Texture (Mobile)	$END_T$	$\pm 0.5$ dB(A)	All 20 m segments to be within tolerance	20 m	N/A
Texture (Static)	$END_T$	$\pm 0.5$ dB(A)	All spot measurements to be within tolerance	N/A	10 m
Absorption	$END_\alpha$	$\pm 0.5$ dB(A)	All spot measurements to be within tolerance	N/A	10 m
Mechanical Impedance <sup>20</sup>	Dynamic stiffness	Unknown	All spot measurements to be within tolerance	N/A	10 m

The tolerance requirements specified in Table C.5 are based on the expert judgement of the SILVIA consortium at the time of writing and *have not been fully validated by field trials*. It is likely that these tolerances will be revised at some point in the future following experience with applying the classification system.

If the chosen 100 m section is suitable, then the labelling procedure continues.

If the chosen section is found to be unsuitable for labelling, another appropriate 100 m section must be identified within the trial length, i.e. a 100 m section with homogeneous texture and suitable for performing an SPB. If a suitable section can be identified, then a new SPB measurement must be performed midway along the section (repeating STAGES 2-6 of this procedure before continuing).

If an alternative 100 m section cannot be located within the trial length then the whole trial length is defined as being unsuitable for labelling so that a new trial length will be required for the surface type to be labelled.

It must next be assessed whether the surface is dense or open-graded, since additional intrinsic measurements are required for open-graded surfaces.

If the surface is dense and there are the required number of  $L_{Amax,m,vref}$  values for labelling, see box below, then the procedure continues to Stage 12, otherwise procedure to Stage 13.

It needs to be established whether there are the required number of  $L_{Amax,m,vref}$  values for labelling. To reduce the influence of different aggregate types and variations in the laying process, a number of  $L_{Amax,m,vref}$  values at different trial locations should be obtained. For the purposes of labelling at one reference speed, then at least two  $L_{Amax,m,vref}$  values at that reference speed is required for each vehicle category, as illustrated in Table A.3 of Appendix A. For the purposes of deriving a generic relationship between  $L_{Amax,m,vref}$  and

<sup>20</sup> There is presently no standard method for the measurement of mechanical impedance; a method has been developed as part of the SILVIA project but further research into its application is required. As such, it is not possible at the present time to specify appropriate tolerances.

speed,  $v_{ref}$ , this procedure should ideally be repeated for at least five different trial sites, as illustrated in Figure A.2 of Appendix A. If there are insufficient values for labelling, a new trial length should be selected and assessed according to the above procedure.

**STAGE 12 (Dense surfaces only):** Determine the corresponding label values for the surface type under study as follows:

- $LABEL2_{SPB}$  Calculate the average  $L_{Amax,m,vref}$  values from each trial length for each vehicle category,  $m$ , at the appropriate reference speed,  $v_{ref}$  km/h as described in Section A.1.2 of Appendix A. The corresponding average third-octave spectra for category 1 vehicle,  $L_{Amax,1,vref,i}$ , should also be recorded, calculated as described in Section A.1.1.3 of Appendix A;
- $LABEL2_{Texture}$  Calculate the average third-octave band enveloped texture level,  $L_{eT,i,Average}$ , in each third-octave band,  $i$ , over the 100 m label section from each trial, and calculate the average value over all trials. In addition, report the octave band texture level in the 5 mm octave band, averaged over the whole of the trial length ( $L_{T,5mm,Average}$ )

If the surface is either open-graded and rigid or open-graded and elastic, the labelling procedure continues with STAGE 13.

**STAGE 13 (Open-graded surfaces only):** In addition to the SPB and texture measurements that have already been taken, it is necessary to perform supplementary intrinsic measurements.

Absorption measurements should be performed at each spot position  $P_{T,m}$  to  $P_{T,m+9}$  within the label section (Figure C.4). If the surface is also elastic then mechanical impedance measurements should also be taken at the same positions.

**STAGE 14 (Open-graded surfaces only):** Determine the third-octave band absorption spectrum,  $\alpha_{i,P_{T,n}}$  in each third-octave band,  $i$ , at each spot position,  $n = m, m+1, \dots, m+9$ , within the 100 m section for labelling together with the average third-octave band absorption spectrum in each third-octave band,  $i$ , for the whole 100 m label section,  $\alpha_{i,Average}$ , should also be determined. If the surface is elastic, then the dynamic stiffness,  $DS_{P_{T,n}}$ ,  $n = m, m+1, \dots, m+9$  should be determined from the mechanical impedance measurements<sup>21</sup> at each spot and the average dynamic stiffness for the trial length,  $DS_{Average}$ , is calculated.

**STAGE 15 (Open-graded surfaces only):** Determine the  $END_{\alpha}$  for each position  $P_{T,m}$  to  $P_{T,m+9}$  within the label section using the equation

$$END_a = 10 \times \log_{10} \frac{\sum_i 10^{(L_{Amax,1,vref,i} - 12\Delta a_i)/10}}{\sum_i 10^{L_{Amax,1,vref,i}/10}} \text{ dB} \quad (C.3)$$

where

<sup>21</sup> There is presently no standard method for the measurement of mechanical impedance; a method has been developed as part of the SILVIA project and further research into its application is required. The suggested measurements are only an indication of how the method might be applied.

- $L_{Amax,1,vref,i}$  is the third-octave band spectral level in each third-octave band,  $i$ , measured at the maximum pass-by noise level,  $L_{Amax,1,vref}$ , for category 1 vehicles at a reference speed  $v_{ref}$  km/h.

$\Delta\alpha_i$  is the third-octave band absorption coefficient difference in each third-octave band,  $i$ , between the average absorption coefficient over the whole of the 100 m label section ( $\alpha_{i,Average}$ ) and the absorption coefficient for each spot position under consideration ( $\alpha_{i,PT,n}$ ) as determined during Stage 14.

The third-octave band frequency range used in the summation expression of Equation C.3 should extend from 250 to 4k Hz.

**STAGE 16 (Open graded surfaces only):** Determine the homogeneity of the 100 m label section in terms of the intrinsic parameters to assess its suitability for labelling. For the chosen absorption index, each of the 10 spot positions must have a corresponding  $END_\alpha$  value,  $END_{a,PT,n}$  that falls within the tolerance defined in Table C.3, i.e.  $\pm 0.5$  dB.

If the surface is also elastic, the homogeneity must also be assessed in terms of the dynamic stiffness, although the tolerance for this is currently undetermined.

The assumption is made that the homogeneity of the surface between measurement spots is consistent and falls within the tolerances specified in Table C.5.

If the chosen section is not fully homogenous, i.e. not all of the  $END_a$  values or dynamic stiffness parameters fall within the required tolerance, it must be agreed between the Customer and the Surface Contractor how to proceed, i.e. whether to accept the section and define the label values based on the available data or whether to identify an alternative 100 m section and repeat the SPB and intrinsic parameter measurements.

If there are the required number of  $L_{Amax,m,vref}$  values for labelling, see box below, then the procedure continues to Stage 17.

At this stage it needs to be established whether, for each vehicle category, there is the required number of  $L_{Amax,m,vref}$  values for labelling. To reduce the influence of different aggregate types and variations in the laying process, a number of  $L_{Amax,m,vref}$  values at different trial locations should be obtained. For the purposes of labelling at one reference speed, then at least two  $L_{Amax,m,vref}$  values at that reference speed is required for each vehicle category is required, as illustrated in Table A.3 of Appendix A. For the purposes of deriving a generic relationship between  $L_{Amax,m,vref}$  and speed,  $v_{ref}$ , this procedure should ideally be repeated for at least five different trial sites, as illustrated in Figure A.2 of Appendix A. If there are insufficient values for labelling, a new trial length should be selected and assessed according to the above procedure.

**STAGE 17 (Open-graded surfaces only):** Determine the corresponding label values for the surface type under study as follows:

- $LABEL2_{SPB}$  Calculate the average  $L_{Amax,m,vref}$  values from each trial length for each vehicle category,  $m$ , at the appropriate reference speed,  $v_{ref}$  km/h as described in Section A.1.2 of Appendix A. The corresponding average third-octave spectra for category 1 vehicle,  $L_{Amax,m,vref,i}$ , should also be recorded, calculated as described in Section A.1.1.3 of Appendix A;

- $LABEL2_{Texture}$  Calculate the average third-octave band enveloped texture level,  $L_{eT,i,Average}$ , in each third-octave band,  $i$ , over the 100 m label section from each trial, and calculate the average value over all trials.
- $LABEL2_{Absorption}$  Calculate the average third-octave band absorption coefficient spectrum level (250 to 4k Hz),  $\alpha_{i,Average}$ , in each third-octave band,  $i$ , over the chosen 100 m section from each trial, and calculate the average value over all trials;
- $LABEL2_{Mech Imp}$  Calculate the average dynamic stiffness over the chosen 100 m section from each trial,  $DS_{Average}$  and calculate the average value over all trials. (only required if the surface is open-graded and elastic)

### C.3 COP-testing

Conformity of Production (COP) is a quality control measure to ensure that the acoustic performance and where relevant the intrinsic properties of a given road length conform to the corresponding label values of a classified road surface type. Each label has a defined range or tolerance which the corresponding values measured for the road length under consideration, are required not to exceed in order to be accepted as conforming to the relevant specification.

It should be noted that where a surface has been labelled according to LABEL1, then any COP assessment must be performed using the procedures relevant to LABEL1 i.e. CPX measurement. Similarly, a surface labelled according to LABEL2 must be COP assessed according to the LABEL2 procedure i.e. the relevant combination of texture, absorption and mechanical impedance measurements. The procedures are not interchangeable between labelling and COP.

The following terminology is used in the COP assessment procedures defined within this section:

- *Road length*: Total length of road which is to be assessed for COP;
- *Road section*: A 100 m section of the road length over which the COP assessment is applied;
- *Road segment*: A 20 m segment of road within a road section identified as the length over which a CPX Index value is averaged.

The road length is assessed as a series of 100 m long sections and the COP is assessed for each individual 100 m section. The consequence of any road section failing the COP assessment is outside the scope of this document. The Customer and Surface Contractor will have to negotiate how to handle these consequences including any appeal procedure. The definition of an appeal procedure is also outside the scope of this document.

It is important to note that when carrying out a COP assessment for a road length based on values determined under LABEL2 procedures, measures relating to the homogeneity of the road section based on the intrinsic property of the surface may rely on a single spot measurement midway along the segment (the exception is where mobile texture measurements are carried out). Under such circumstances, this measure of homogeneity should be treated with caution.

It is therefore recommended, wherever possible, that LABEL1 procedures are the preferred method so that in assessing for COP, more confidence can be attached to the results.

The COP procedures outlined here have not been assessed in practice due to the timescale for the development of the classification system within the SILVIA project. It is therefore recommended that care is exercised when following these procedures and that the recommended tolerances might require adjustment in the light of practical experience.

### C.3.1 Procedure for COP assessment using LABEL1 values

THIS PROCEDURE SHOULD IDEALLY BE CARRIED OUT AFTER THE ROAD LENGTH HAS BEEN OPEN TO TRAFFIC FOR TWO MONTHS.

The procedure for assessing COP according to LABEL1 is based on performing CPX measurements, using the site layout shown in Figure C.7

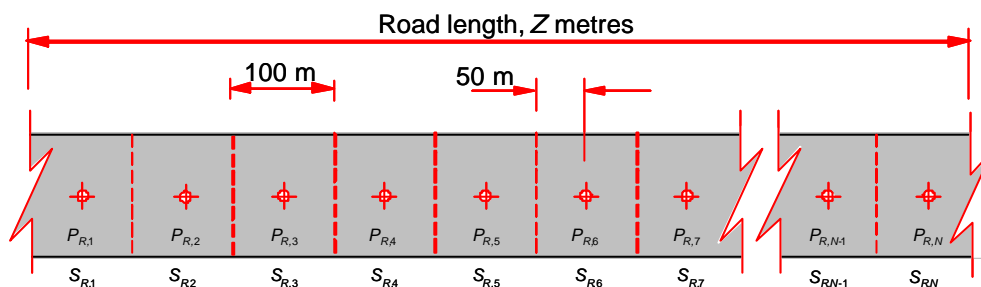

Figure C.7: Site layout for measurements to assess COP according to LABEL1 parameters

The procedure is shown schematically as a flow chart in Figure C.8 and is as follows:

**STAGE 1:** Carry out CPX measurements along the whole length of the  $Z$  m long road length. The road length should be considered as being comprised of  $N$ , 100 m segments,  $S_{R,1}$ ,  $S_{R,2}$ , ...,  $S_{R,N}$

**STAGE 2:** Determine the CPX Index for each individual 100 m road section, i.e.  $CPXI_{S_{R,n}}$ ,  $n = 1, 2, \dots, N$ , calculated as the average of the CPXI indices for the five, 20 m, road segments within each 100 m section.

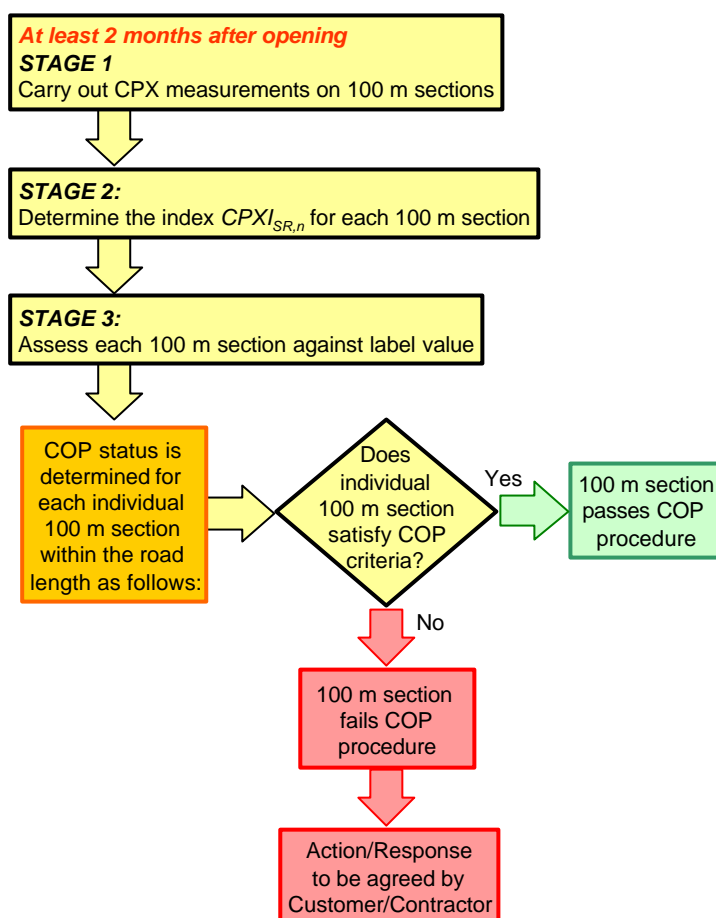

Figure C.8: Flowchart showing procedure for assessing COP using LABEL1 values

**STAGE 3:** The COP assessment of the road length is made by assessing and then passing or failing each individual 100 m section in turn, rather than looking at the overall road length. It is between the Customer and the Surface Contractor to assess how section failures are addressed.

Assess the quality of each individual 100 m section within the road length by comparing the CPX Index for each section,  $CPXI_{SR,n}$   $n = 1, 2, \dots, N$ , with the equivalent label value for the surface type. A section is deemed to have passed the COP assessment if the CPXI value falls within the tolerance defined in Table C.6, i.e.  $COP_{CPX,SR,n} \leq LABEL1_{CPX} + 1.5$  dB(A).

The tolerance requirements specified in Table C.6 are based on the expert judgement of the SILVIA consortium at the time of writing and *have not been fully validated by field trials*. It is likely that these tolerances will be revised at some point in the future following experience with applying the classification system.



Table C.6: Tolerances for COP assessment using LABEL1 values

Measurement Type	Label ID	Label Type	Assess COP using	Tolerance
CPX	$LABEL1_{CPX}$	CPXI	CPXI	$\leq LABEL1_{CPX} + 1.5 \text{ dB(A)}$
SPB Supplementary checks only	$LABEL1_{SPB}$	$L_{Amax,m,vref}$	$L_{Amax,m,vref}$	$\leq LABEL1_{SPB} + 1.5 \text{ dB(A)}$

It is noted that Table C.6 includes tolerance data for SPB measurements. The preferred approach is to assess COP using CPX measurements, although it is acknowledged that SPB measurements could be used, although there is a far greater risk involved, since the SPB measurement only addresses a very localised section of the surface, whereas the CPX measurements are high resolution along the full length of the surface being assessed. It is considered that that SPB measurements may be used in circumstances where the CPX measurements indicate the surface to have failed the COP procedure and the surface contractor and customer agree that supplementary measurements should be carried out. It will be the responsibility of these two parties to determine the course of action if the CPX measurements fail the COP assessment but the SPB assessment meets the specified tolerances.

### C.3.2 Procedure for COP assessment using LABEL2 values

THIS PROCEDURE SHOULD IDEALLY BE CARRIED OUT AFTER THE ROAD LENGTH HAS BEEN OPEN TO TRAFFIC FOR TWO MONTHS.

The procedure for assessing COP according to LABEL2 is based on performing texture measurements and, if relevant, absorption and mechanical impedance measurements, using the site layout shown in Figure C.9.

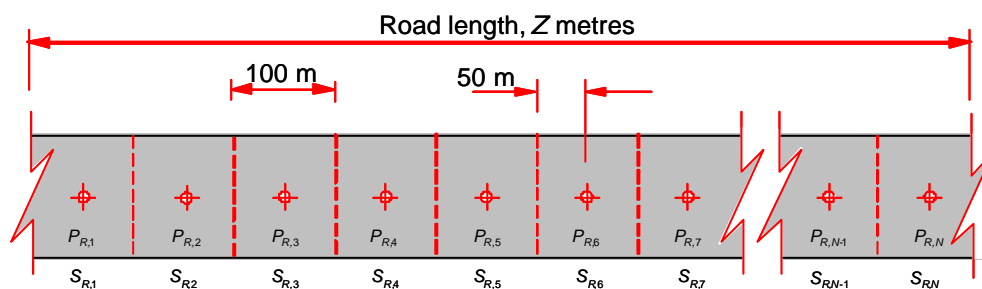

Figure C.9: Site layout for measurements to assess COP according to LABEL2 parameters

The procedure is shown schematically on the following pages as a flow chart in Figure C.10 and Figure C.11 and is as follows:

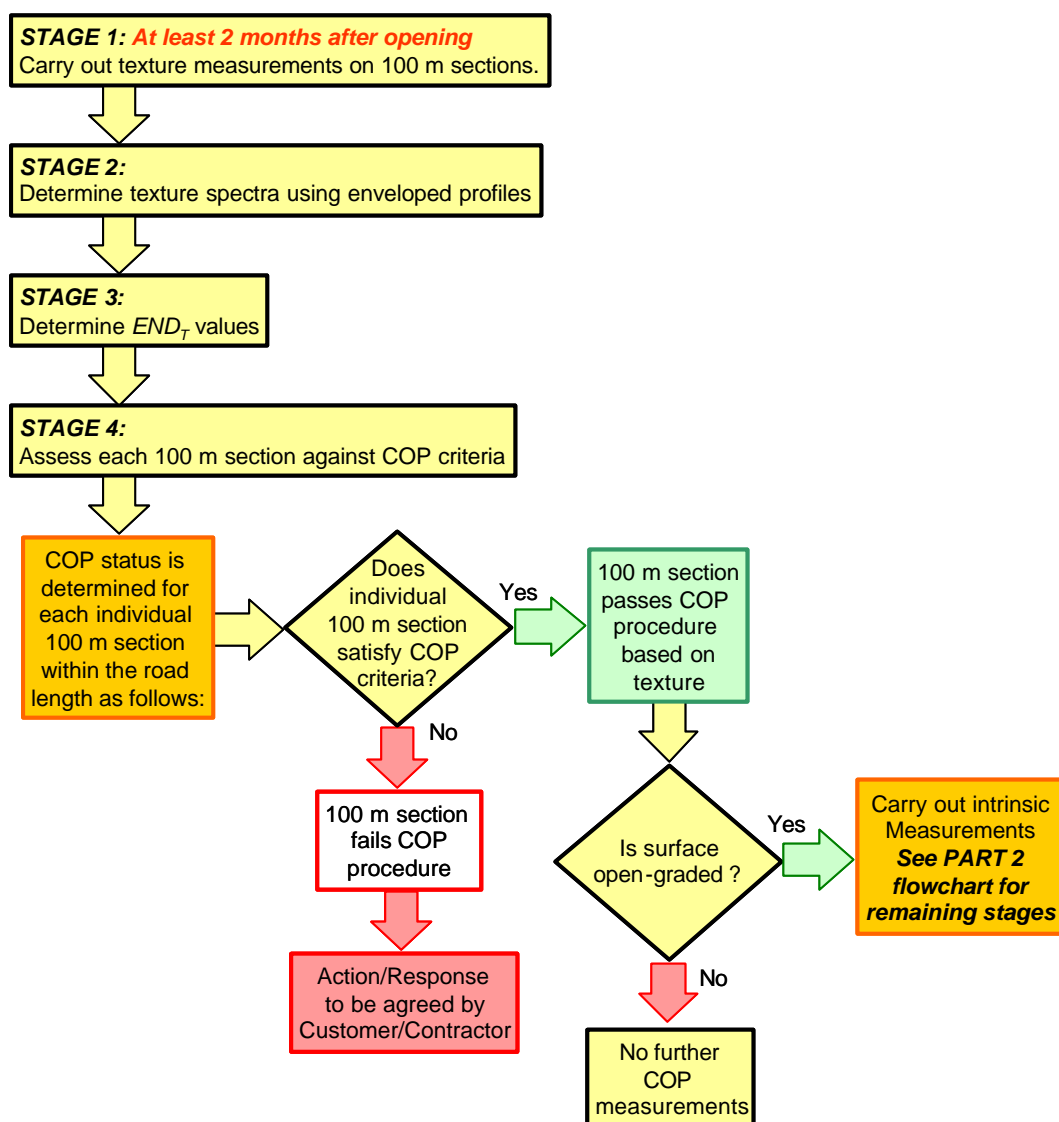

Figure C.10: PART 1 flowchart showing procedure for assessing COP using LABEL2 values

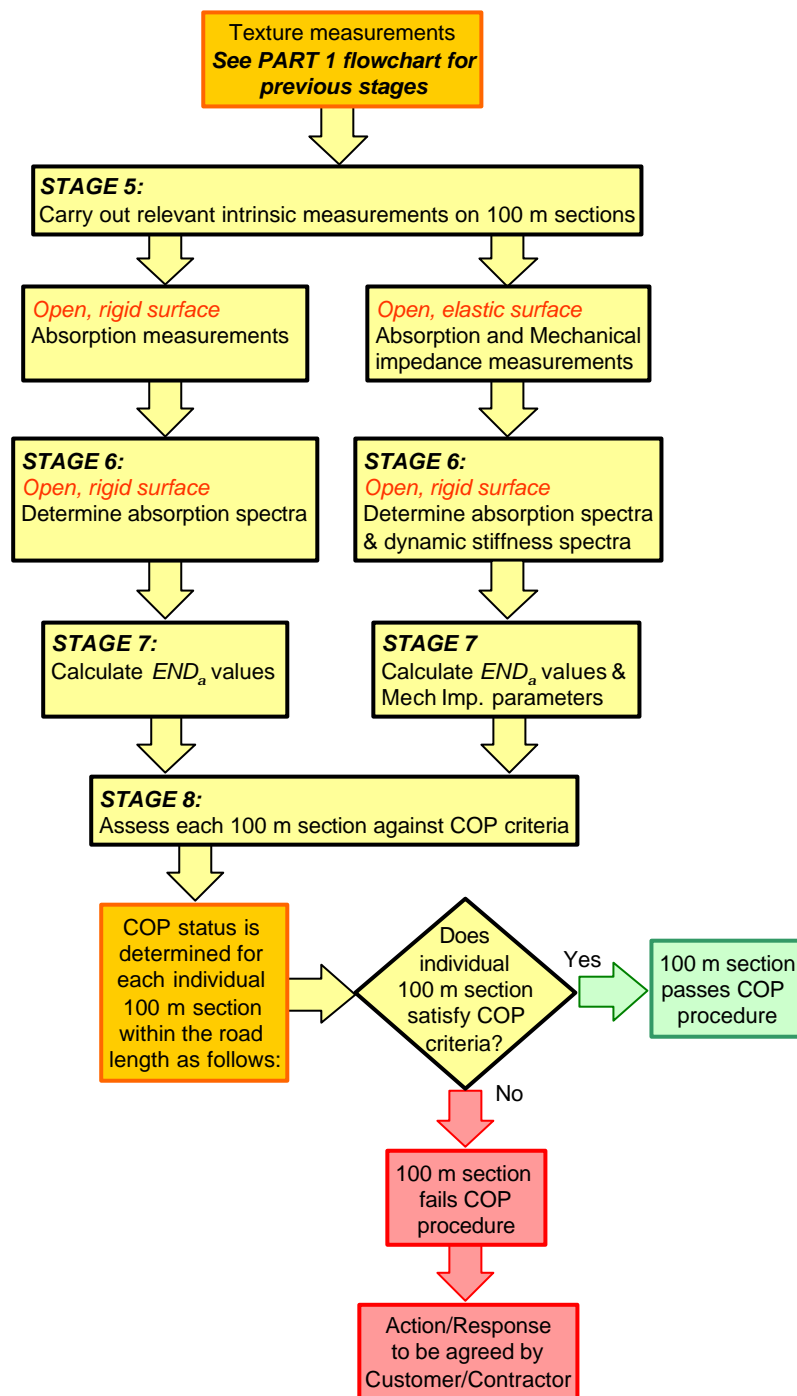

Figure C.11: PART 2 flowchart showing procedure for assessing COP using LABEL2 values

**STAGE 1:** Carry out texture measurements along the whole  $Z$  m length of the road length. The site should be considered as being comprised of  $N$ , 100 m sections. If static texture measurements are being used, these should be taken at the midpoint of each 100 m section.

**STAGE 2:** Using the enveloped texture profile (envelopment parameter  $E = 1 \text{ MN/m}^2$ ), determine the third-octave band texture spectrum

- $L_{eT,i,SR,n}$ , for each 100 m road section  $S_{R,n}$ <sup>22</sup>,  $n = 1, 2, \dots, N$  (if using mobile texture measurements), or
- $L_{eT,i,PR,n}$  for each spot position  $P_{R,n}$ ,  $n = 1, 2, \dots, N$  (if using static texture measurements).

For dense surfaces, an additional parameter is required, the texture level in the 5 mm octave band wavelength for each segment (mobile texture measurements) or at each spot (static texture measurements),  $L_{T,5mm,SR,n}$  or  $L_{T,5mm,PR,n}$ , respectively, together with the average texture level over the trial length,  $L_{T,5mm,Average}$ .

**STAGE 3:** Determine the  $END_T$  (the estimated pass-by noise level difference from texture level variations) for each segment  $S_{R,n}$  or position  $P_{R,n}$  using the equation

$$END_T = 10 \times \log_{10} \frac{\sum_i 10^{(L_{Amax,1,vref,i} + b_i \cdot \Delta L_{eT,i})/10}}{\sum_i 10^{L_{Amax,1,vref,i}/10}} \text{ dB} \quad \text{for open-graded surfaces, or (C.4)}$$

$$END_T = 10 \times \log_{10} \frac{\sum_i 10^{(L_{Amax,1,vref,i} + b_i \cdot \Delta L_{eT,i})/10}}{\sum_i 10^{L_{Amax,1,vref,i}/10}} - 0.25 \Delta L_{T,5mm} \text{ dB for dense surfaces. (C.5)}$$

where

- $L_{Amax,1,vref,i}$  is the third-octave band spectral level in each third-octave band,  $i$ , measured at the maximum pass-by noise level,  $L_{Amax,1,vref}$ , for category 1 vehicles at a reference speed  $v_{ref}$  km/h, as reported under the  $LABEL2_{SPB}$  procedure.
- $\Delta L_{eT,i}$  is the third-octave band enveloped texture level difference in each third-octave band,  $i$ , at a given speed  $v_{ref}$  km/h between the average enveloped texture spectrum reported under  $LABEL2_{Texture}$  procedure and the enveloped texture measured for the segment or spot position under consideration ( $L_{eT,SR,n}$  or  $L_{eT,PR,n}$ , respectively) as determined during Stage 2;
- $b_i$  are the coefficients given in Table C.7, and
- $\Delta L_{T,5mm}$  is the texture level difference in the 5 mm wavelength octave band between the average texture level reported with the label ( $LABEL2_{Texture}$ ) and the texture level measured for the segment or spot position under consideration ( $L_{T,5mm,SR,n}$  or  $L_{T,5mm,PR,n}$ ) as determined during Stage 2;

<sup>22</sup> The subscript R denotes that this is a segment at a road location, R

Table C.7:  $b_i$  coefficients for calculating  $END_T$ 

f (Hz)	250	315	400	500	630	800	1000	1250	1600	2000	2500	3150	4000
$b_i$	0.90	0.85	0.80	0.75	0.70	0.65	0.40	0.0	0.0	0.0	0.0	0.0	0.0

**STAGE 4:** The COP assessment of the road length is made by assessing and then passing or failing each individual 100 m section in turn, rather than looking at the overall road length. It is between the customer and the surface contractor to assess how section failures are addressed.

Assess the quality of each individual 100 m section with the road length relative to the equivalent label value for the surface type by determining if the level difference for each 100 m section,  $END_{T,SR,n}$  and  $END_{T,PR,n}$  for mobile and static texture measurements respectively, falls within the tolerance defined in Table C.8, i.e.  $END_T \leq \pm 1.5$  dB.

If the 100 m section passes the COP assessment with respect to texture, it must next be assessed whether the surface is open-graded and rigid or open-graded and elastic. If the surface conforms to neither of these categories then the COP assessment is complete and no further measurements are required. If the surface conforms to one of these categories, then the procedure moves to Stage 5, as shown in Figure C.11

Table C.8: Tolerances for COP assessment using LABEL2 values

Measurement Type	Label ID	Label Type	Assess COP using	Tolerance
Texture (Static)	$LABEL2_{Texture}$	$T_i$	$END_T$	$\leq 1.5$ dB(A)
Texture (Mobile)	$LABEL2_{Texture}$	$T_i$	$END_T$	$\leq 1.5$ dB(A)
Absorption	$LABEL2_{Absorption}$	$\alpha_i$	$END_\alpha$	$\leq 1.5$ dB(A)
Mechanical impedance	$LABEL2_{Mech Imp}$	Dynamic stiffness	Dynamic stiffness	Unknown
SPB Supplementary checks only	$LABEL1_{SPB}$	$L_{Amax,m,vref}$	$L_{Amax,m,vref}$	$\leq LABEL1_{SPB} + 1.5$ dB(A)

The tolerance requirements specified in Table C.6 are currently based on the expert judgement of the SILVIA consortium and *have not been fully validated by field trials*. It is likely that these tolerances will be revised at some point in the future following experience with applying the classification system.

**STAGE 5 (Open-graded surfaces only):** In addition to texture measurements that have already been taken, it is necessary to perform supplementary intrinsic measurements.

Absorption measurements should be performed midway along each 100 m section at positions,  $P_{R,n}$ ,  $n = 1, 2, \dots, N$ . If the surface is also elastic then mechanical impedance measurements should also be taken at the same positions.

**STAGE 6 (Open-graded surfaces only):** Determine the third-octave band absorption spectrum at each spot position, i.e.  $\alpha_{i,PR,n}$ ; If the surface is elastic, then the dynamic stiffness,  $S_{T,PR,n}$  should also be measured.<sup>23</sup>

**STAGE 7 (Open-graded surfaces only):** Determine the  $END_{\alpha}$  for each position  $P_{R,n}$  using the equation

$$END_a = 10 \times \log_{10} \frac{\sum_i 10^{(L_{A_{max,1,ref,i}} - 12\Delta a_i)/10}}{\sum_i 10^{L_{A_{max,1,ref,i}}/10}} \text{ dB} \quad (\text{C.6})$$

where

- where  $L_{A_{max,1,ref,i}}$  is the third-octave band spectral level in each third-octave band,  $i$ , defined by the SPB label ( $LABEL2_{SPB}$ ) for the equivalent surface type, for category 1 vehicles at a reference speed  $v_{ref}$  km/h.

$\Delta a_i$  is the third-octave band absorption coefficient difference in each third-octave band,  $i$ , between the absorption coefficient defined by the label  $LABEL2_{Absorption}$  and the absorption coefficient for each spot position under consideration ( $\alpha_{i,PR,n}$ ) as determined during Stage 6.

The third-octave band frequency range should extend from 250 to 4k Hz.

If the surface is also elastic, the dynamic stiffness also needs to be determined at position  $P_{R,n}$  where  $n = 1, 2, \dots, N$ .

**STAGE 8 (Open-graded surfaces only):** As already noted, the COP assessment of the road length is made by assessing and then passing or failing each individual 100 m section in turn, rather than looking at the overall road length. It is between the customer and the surface contractor to assess how section failures are addressed.

Assess the quality of each individual 100 m section with the road length relative to the equivalent label value for the surface type by determining if the level difference for each 100 m section,  $END_{a,PR,n}$  falls within the tolerance defined in Table C.7, i.e.  $END_{\alpha} \leq \pm 1.5$  dB.

It is important to note that when carrying out a COP assessment for a road length based on values determined under LABEL2 procedures, measures relating to the homogeneity of the road section based on the intrinsic property of the surface may rely on a single spot measurement midway along the segment (the exception is where mobile texture measurements are carried out). Under such circumstances, this measure of homogeneity should be treated with caution.

**It is therefore recommended, wherever possible, that LABEL1 procedures are the preferred method so that in assessing for COP, more confidence can be attached to the results.**

<sup>23</sup> There is presently no standard method for the measurement of mechanical impedance; a method has been developed as part of the SILVIA project but further research into its application is required. The suggested measurements are only an indication of how the method might be applied. Appropriate tolerances have not yet been identified.

The COP procedures outlined here have not been assessed in practice due to the timescale for the development of the classification system within the SILVIA project. It is therefore recommended that care is exercised when following these procedures and that the recommended tolerances might require adjustment in the light of practical experience.

## C.4 Monitoring

For monitoring purposes a periodical test is proposed. The time interval between tests is variable and will depend on the acoustic durability of the road surface; for instance once every five years for concrete surfaces and once every 2 years for porous surfaces.

It should be noted that these monitoring durations are only *recommendations*; clearly, the chosen duration will be very much dependent upon local conditions and local requirements.

The proposals for monitoring outlined here do not address the durability of the surface in any great detail; the classification system described only addresses the performance of the surface *when it is newly laid* and not how it should perform over time. The durability of the surface will be dependent upon local conditions and therefore cannot easily be routinely specified. Furthermore, the lifetime performance of a surface could be specified in a number of ways, e.g. X dB(A) reduction per year, total reduction of X dB(A) before replacement, etc. It was not feasible to propose a standard definition that was considered appropriate for all surfaces.

Routine monitoring will provide information on the durability of these low-noise surfaces; this is particularly important for new designs of surface. When the classification system is applied to existing surfaces (which still requires that test sections be laid, although these will be based on existing material and structural specifications) the surface contractor may already have sufficient information on durability of the surface to allow lifetime criteria to be stated as an additional component of the classification label.

The preferred test method that is proposed for monitoring is the CPX method. The road authority has to decide if they want to do the test with passenger car tyres only or with two tyres, one representing the passenger car tyres and one representing truck tyres. Further measuring absorption and texture are recommended.

If CPX measuring equipment is not available the test may also be executed using the texture method and if applicable absorption and mechanical impedance measurements.

### C.4.1 Potential uses for monitoring information

The monitoring application described in the above paragraphs refers to monitoring how the performance of a road surface changes over time relative to the defined acoustic label with the emphasis on single roads or stretches of road.

However, of increasing interest to highway authorities is the performance of the whole road network for which that authority is responsible. Monitoring using CPX is a fast and

efficient way of achieving this and the data generated can be used to generate noise maps showing the noise performance of the surface along its length. Appendix A.2.6 gives examples of how CPX measurements have been applied for this purpose.



## Appendix D. Application of the SILVIA classification system

Appendix D is included in the Manual to provide guidance on the application of the SILVIA classification system, and is structured as follows:

- Section D.1, “*Guidelines for stakeholders*”, provides advice to the stakeholders for whom the classification system has been developed. It includes a method for assessing the acoustic performance of road surfaces in terms of changes in traffic noise levels that may assist road planners and politicians in making appropriate choices between different surface types;
- Section D.2, “*Determining road surface corrections*”, describes the procedures for determining a correction for road surfaces that is required as input to several traffic noise prediction models used by Member States and to the European model, HARMONOISE, to allow the acoustic performance of a road surface to be assessed at a distance from the road so that the effects of propagation and other site factors may be taken into consideration;
- Section D.3 (*Reference surfaces*) describes a number of reference surfaces that have been introduced by Member States including that to be used in HARMONOISE. The use of reference surfaces allows the relative assessment/benchmarking of the acoustic performance of a road surface.

### D.1 Guidance for stakeholders

#### D.1.1 Guidance for planners and politicians

Planners, politicians, discussion groups and so on need a system that is easy to use and provides a simple assessment of the likely impact a road surface may have on overall traffic noise levels alongside a road. The following paragraphs provide a method to allow label SPB values to be used in estimating changes in traffic noise levels. Alternatively, such levels may be calculated by Member States using their own equations or methodologies. However, where such an approach is not already available, it is suggested to use the method described below.

The following example is provided to illustrate the type of procedure required to compare traffic noise levels alongside roads with different surfaces and is **based on** the method adopted in the **UK** Highway Authorities Product Approval Scheme (HAPAS) system [108]. The procedure set out below allows Member States to use traffic variables appropriate to their own local conditions.

For comparison purposes, two surfaces are identified. The first is the trial surface for which the overall A-weighted SPB noise label for each vehicle category, according to the procedure described in Appendix A of the Manual, have been derived. The second

surface is the reference surface for which the corresponding SPB noise label for each vehicle category is known. See Section D.3 for information related to reference surfaces.

In this example, the traffic noise level from a given flow of traffic, composition and speed travelling on the trial surface is compared with the noise from the same traffic travelling on the reference surface. The traffic composition is divided into 3 vehicle categories:

- *Category 1*: light vehicles including passenger cars and car derived vans, excluding vehicles towing trailers;
- *Category 2*: commercial trucks with 2 axles;
- *Category 3*: commercial trucks with more than two axles.

The average speed and percentage of vehicles in each vehicle category is assumed to be typical for the type of road that the trial surface is to be considered for use on, e.g. motorway, urban etc. To be applicable, the average speed of the vehicles in each category must lie within the speed range for which the labelled SPB noise levels for both the trial and reference surfaces have been validated

The difference in traffic noise,  $\Delta_{traffic\ noise}$ , from vehicles travelling on the trial surface compared with that for the reference surface can be estimated from the following equation:

$$\Delta_{traffic\ noise} = 10 \times \log_{10} \left\{ \frac{p_1 \times 10^{SEL_1/10} + p_2 \times 10^{SEL_2/10} + p_3 \times 10^{SEL_3/10}}{p_1 \times 10^{SEL_{1r}/10} + p_2 \times 10^{SEL_{2r}/10} + p_3 \times 10^{SEL_{3r}/10}} \right\} \text{dB(A)} \quad (\text{D.1})$$

where

$p_1$ ,  $p_2$  and  $p_3$  are the percentage of vehicles in the traffic stream (expressed as a fraction of the total flow) corresponding to the vehicle categories defined above for typical traffic conditions for the type of road under consideration;

$SEL_1$ ,  $SEL_2$  and  $SEL_3$  are the average sound exposure levels of the pass-by noise levels of vehicles in each of the respective vehicle categories, 1, 2 and 3 derived from the SPB noise labels for the trial surface using the following appropriate equations:

$$SEL_1 = LABEL_{SPB,1} - 10 \times \log_{10} v_1 \text{ dB(A)} \quad (\text{D.2})$$

$$SEL_2 = LABEL_{SPB,2} - 10 \times \log_{10} v_2 \text{ dB(A)} \quad (\text{D.3})$$

$$SEL_3 = LABEL_{SPB,3} - 10 \times \log_{10} v_3 \text{ dB(A)} \quad (\text{D.4})$$

where  $v_1$ ,  $v_2$  and  $v_3$  are the average vehicle speeds corresponding to the vehicle categories defined above that are typical of traffic conditions for the type of road under consideration and  $LABEL_{SPB,1}$ ,  $LABEL_{SPB,2}$  and  $LABEL_{SPB,3}$  are the corresponding SPB noise label values for each vehicle category.

Similarly for the reference surface:

$$SEL_{1r} = LABEL_{SPB,1r} - 10 \times \log_{10} v_1 \text{ dB(A)} \quad (D.5)$$

$$SEL_{2r} = LABEL_{SPB,2r} - 10 \times \log_{10} v_2 \text{ dB(A)} \quad (D.6)$$

$$SEL_{3r} = LABEL_{SPB,3r} - 10 \times \log_{10} v_3 \text{ dB(A)} \quad (D.7)$$

where  $LABEL_{SPB,1r}$ ,  $LABEL_{SPB,2r}$  and  $LABEL_{SPB,3r}$  are the SPB noise labels for the corresponding vehicle categories defined above.

N.B. Equations (D.2) to (D.7) should include a constant term which is dependent on how the noise sources are distributed differently for each vehicle type (see Section D.2.2.1) and also on the site layout where the SPB measurements are taken. As a first approximation it is assumed that all the sources on the vehicle act as a single point noise source at a common position and that the site layout where the SPB measurements are carried out for both the trial surface and reference surface are similar. Under such circumstances, the constant term in each of the above mentioned equations is assumed to be identical and when substituted into equation (D.1) can therefore be cancelled out.

Table D.1 shows an example of how information derived from the application of this procedure might be used. Noise reductions relative to a reference surface, in this case hot rolled asphalt 0/20 (HRA), have been calculated for 3 different fleet compositions on a high speed road and a range of different surface types. The surfaces have then been grouped in 2 dB(A) reduction bands relative to the reference. It can be seen in the Table that the performance of surfaces changes dependent on the fleet composition assumed e.g. the dense asphalt concrete (DAC).

Table D.1: Example of the performance of different surfaces on high-speed roads for different fleet compositions (SPB data based on the average values for each surface type quoted in Chapter 4)

Reduction Class dB(A)	Fleet composition 1: 97% Cat1, 2% Cat2, 1% Cat 3		Fleet composition 3: 90% Cat1, 4% Cat2, 6% Cat 3		Fleet composition 3: 70% Cat1, 10% Cat2, 20% Cat 3	
	Product type	Reduction relative to ref. surface	Product type	Reduction relative to ref. surface	Product type	Reduction relative to ref. surface
0 to +2.0	SD	1.4	SD	1.3	SD	1.0
Reference	HRA	---	HRA	---	HRA	---
0 to -2.0						
-2.0 to -4.0	EACC	-2.3	EACC	-2.2	EACC	-2.0
	SMA	-3.9	SMA	-3.3	SMA	-2.3
	TSF	-3.9	DAC	-3.5	DAC	-2.5
			TSF	-3.8	TSF	-3.5
-4.0 to -6.0	DAC	-4.1			PAC	-5.4
> -6.0	PAC	-7.0	PAC	-6.4	DPAC	-7.1
	DPAC	-8.1	DPAC	-7.8		

It should be noted that for this example, the SPB data used as input to equations (D.2)-(D.7) are the *average levels* over the lifetime of the surfaces as collated in Chapter 4 of this Manual, i.e. the levels do not correspond to surfaces that are all of a similar age

### D.1.2 Specifications for contracting parties

For contracting parties, the following points should be noted:

- For road authorities, the reduction of the noise levels at the dwellings is the most relevant measure of performance. But in order to specify the required reduction, the fleet composition, the traffic speed and influences on sound propagation should all be taken into account. Dependence on local factors would make the specification too complex and leave contractors to take the risk of non-compliance;
- Specifying performance in terms of a reduction of the emission per vehicle category at a defined speed may still lead to differences in measured values due to differences in local propagation conditions and sources. It would be necessary to specify the conditions under which the measurements have been carried out;
- Specifying a road surface in terms of a process that has previously demonstrated the required level of performance leaves some doubt about whether it provides a similar performance when used elsewhere.

- Specifying performance in terms of a COP test using the CPX method is arguably the simplest approach. This permits the requirements to be checked before and after construction. The main problem is that this method does not guarantee a specific level of overall performance, because the CPX-values do not translate consistently into reductions per vehicle category.

### D.1.3 Specifications for environmental officers

Environmental officers involved in assessing the noise impact of a road scheme on residential properties and other noise sensitive locations require data on the acoustic performance of road surfaces to provide input to traffic noise prediction models used for environmental impact assessments. The format of the acoustic data input will vary depending on the requirements of the traffic noise prediction model used for the assessment and how sophisticated the model performs.

Generally, the acoustic performance of a road surface is given relative to a reference surface and input to the most basic prediction model is often referred to as a road surface correction derived from overall SPB noise levels for each vehicle category. Section D.3 discusses the range of surfaces which have been considered for use as a reference surface.

However, it is important that when assessing the acoustic performance of a road surface, propagation effects are taken into consideration. The influence of barriers, ground absorption and meteorological effects on noise propagation are all frequency dependent. The acoustic performance of a road surface based on overall vehicle noise levels is not, therefore, sufficiently robust and input data to more sophisticated models require spectral information for each vehicle category.

The next section describes the procedure for determining the road surface correction typically required as input to traffic noise prediction models.

## D.2 Determining road surface corrections

The first part of this section provides guidance on the procedures for assessing the performance of a road surface relative to a reference surface. The initial procedure uses overall vehicle noise levels derived from SPB measurements to derive a road surface correction,  $C_{road, m, v}$ , for each vehicle category,  $m$ , at a reference speed,  $v$  km/h.

This is followed by a section describing procedures to allow spectral information derived from SPB measurements to provide input data to the European traffic noise prediction model HARMONOISE and as a consequence allow propagation effects to be more fully taken into account when assessing the influence of road surfaces on the environmental impact of road traffic noise.

### D.2.1 Determination of the road surface correction factor $\Delta_{road,m,v}$

The road surface correction,  $\Delta_{road,m,v}$ , indicates the difference between vehicle noise emissions for different vehicle categories travelling on a road surface of a certain type and the corresponding emissions on a reference road surface at a given reference speed,  $v$  km/h. The determination of  $\Delta_{road,m,v}$  is based on a number of SPB trial results that are carried out during the labelling of a road surface type, as described in Section A.1.2..

The regression line through the valid SPB noise values provides the resulting line for the road surface type under study, as shown in Equation (A1.6):

$$LABEL_{SPB,m,v,surface} = a_{m,surface} + b_{m,surface} \times \log_{10}(v) \text{ dB(A)}. \quad (D.8)$$

Similarly, the corresponding regression line for the reference surface can be described in a similar manner, i.e.

$$LABEL_{SPB,m,v,ref} = a_{m,ref} + b_{m,ref} \times \log_{10}(v) \text{ dB(A)}. \quad (D.9)$$

The road surface correction is calculated by subtracting the two formulae:

$$\Delta_{road,m,v} = LABEL_{SPB,m,v,surface} - LABEL_{SPB,m,v,ref}. \quad (D.10)$$

The road surface correction is valid between the speed range  $v_{min}$  to  $v_{max}$ , where  $v_{min}$  is determined as being the lowest speed at which at least two SPB values are available, and  $v_{max}$  is determined as the highest speed at which at least two SPB values are available for both the trial and reference surfaces, as described in Section A.1.2.

### D.2.2 Estimating the road surface correction within the HARMONOISE source model

This section of the Appendix sets out the recommended procedures for estimating the road surface correction for surfaces within the HARMONOISE source model using the normalised average octave band spectra for a vehicle category at a given reference speed. Road surface corrections are defined relative to those surfaces identified in the reference road cluster (i.e. SMA and DAC with maximum stone size from 8 to 15 mm).

The first part of this section provides an overview of the source model which is described in deliverable D9 of the HARMONOISE project [153]. This is followed by a description of the procedure for determining the appropriate road surface correction required as input to the HARMONOISE model. The final section discusses some of the assumptions and limitations in the methodology.

#### D.2.2.1 The HARMONOISE source model

The source model categorises vehicles into three main categories:

- *Light vehicles*: include cars, SUVs, MPVs and light vans up to 9 seats with a maximum of two wheels per axles (category 1);

- *Medium heavy vehicles*: include 2 axle trucks and buses with a maximum of 4 wheels per axle (category 2).
- *Heavy vehicles*: consist of heavy vehicles with more than two axles (category 3 vehicles).

This classification system follows closely to that used in the SILVIA classification system, although a further two classes which cover two-wheelers and specialist heavy vehicles used for construction and agriculture and by the military are included.

In order to be able to combine the source model with an appropriate propagation model it is necessary to describe the source as a number of point sources. In HARMONOISE two source heights are used for each vehicle category. One is 0.01 m above the road surface and the other is either at 0.3 m for category 1 vehicles or 0.75 m for category 2 and 3 vehicles. For heavy vehicles with high exhausts (stack exhausts) an additional position at 3.5 m is used. However, emission data for these vehicles are not yet available.

The model assumes that 80% of the tyre/road noise radiates from the lower source, whereas, 20% is assumed to radiate from the higher source. This allows for some “smearing” of the sources which in practice rarely takes the form of discrete point sources.

The model describes noise emissions in terms of sound power levels which allows for the directivity of the source to be taken into account. The sound power level for the tyre/road component at a reference speed,  $v_{ref} = 70$  km/h is described by the equation:

$$L_{R,W,m,v,i} = a_{R,m,v,i} + b_{R,m,v,i} \times \log_{10} \left[ \frac{v}{v_{ref}} \right] \text{ dB} \quad (\text{D.11})$$

where  $L_{R,W,m,v,i}$  is the sound power level of the tyre/road source noise in the third-octave band centre frequency,  $i$ , for vehicle category  $m$ , travelling at  $v$  km/h.

The regression coefficients  $a_{R,m,v,i}$  and  $b_{R,m,v,i}$  for each vehicle category,  $m$ , are contained within the HARMONOISE report [153].

For category 2 (2 axle medium heavy vehicles) and category 3 (heavy vehicles with >2 axles) vehicles the speed dependent coefficients,  $b_{R,m,v,i}$ , are identical across the frequency range, and that sound power levels increase with the number of axles, such that :

$$L_{R,W,3,v,i} = a_{R,2,v,i} + b_{R,2,v,i} \times \log_{10} \left[ \frac{v}{v_{ref}} \right] + 10 \times \log_{10} \left[ \frac{\text{number of axles}}{2} \right] \text{ dB} \quad (\text{D.12})$$

The default assumption is that a category 3 vehicle on average has 4 axles. Large city buses will often have 3 axles and long distance freight trucks will on average have at least 5 axles.

For propulsion noise, 80% of the sound power is assumed to radiate from a source at a height of 0.3 m for light vehicles and at a height of 0.75 m for heavy vehicles.

Note that 20% of the sound power is assumed to radiate from the low source 0.01 m above the road surface for all vehicle types. In contrast to tyre/road noise it has been found that propulsion noise is best described as a linear function of speed:

$$L_{P,W,m,v,i} = a_{P,m,v,i} + b_{P,m,v,i} \times \left[ \frac{v - v_{ref}}{v_{ref}} \right] \text{ dB} \quad (\text{D.13})$$

where the speed coefficient  $b_{P,m,v,i}$  is the same for category 2 and category 3 vehicles whereas  $a_{P,m,v,i}$  varies across all categories. The reference speed  $v_{ref}$  is again at 70 km/h.

### D.2.2.2 Estimation of the road surface correction

The input requirements of the HARMOMOISE model depend on providing a third-octave sound power spectrum of the tyre/road noise source for a vehicle category,  $m$ , at speed,  $v$  km/h travelling on the trial surface. This spectrum is then compared with the corresponding spectrum for the reference surface used in the HARMOMOISE model. Details of the reference surfaces used in the HARMONOISE model are given later in Section D.3. For each third-octave band,  $i$ , a road surface correction,  $?_{road,m,v,i}$  can then be derived.

The following procedure allows the road surface correction to be estimated.

#### **Converting to third-octave band levels:**

The initial step is to convert the normalised averaged octave band spectra for a vehicle category obtained from the labelling process into third-octave band spectra, as described in SILVIA classification procedure, see Appendix A, Section A.1.3.

#### **Derive the maximum level contributed by the propulsion noise source:**

The total maximum pass-by noise level,  $L_{T,Amx,m,v,i}$  for a vehicle category,  $m$ , at a speed,  $v$  km/h and third-octave band centre frequency,  $i$ , is a result of radiation from all sub-sources. It is estimated from the temperature corrected SPB noise data derived as described in Appendix A. The total maximum level  $L_{T,Amx,m,v,i}$  is obtained by adding the contributions from the tyre/road noise  $L_{R,Amx,m,v,i}$  and propulsion noise  $L_{P,Amx,m,v,i}$ .

$$L_{T,Amx,m,v,i} = 10 \log_{10} \left( 10^{\frac{L_{R,Amx,m,v,i}}{10}} + 10^{\frac{L_{P,Amx,m,v,i}}{10}} \right) \text{ dB(A)} \quad (\text{D.14})$$

From equation (D.14) we can write that:

$$L_{R,Amx,m,v,i} = 10 \log \left( 10^{\frac{L_{T,Amx,m,v,i}}{10}} - 10^{\frac{L_{P,Amx,m,v,i}}{10}} \right) \text{ dB(A)} \quad (\text{D.15})$$

If it is assumed that the contribution from the propulsion noise is independent of surface type, the HARMONOISE model can be used to derive the propulsion noise levels using Equation (D.13) and provide input to Equation (D.15) which together with the SPB derived spectrum levels,  $L_{T,Amx,m,v,i}$ , allows the tyre/road noise spectrum,  $L_{R,Amx,m,v,i}$ , to be derived. However, Equation (D.13) provides the third-octave band power spectrum which



need to be converted to third-octave band maximum A-weighted noise levels before Equation (D.15) can be used.

A table of transfer functions, Table D.1, has been produced listed by third-octave band frequency for both tyre/road noise and propulsion noise sources with a hard reflected surface having an air flow resistance of  $200 \text{ M Pa s / m}^2$  (Jonasson, 2004) and these have been adjusted to give the level difference between power levels and maximum pass-by levels, for each vehicle category, taking into account the reflection effects of the road surface and for tyre/road noise the directivity of the source. For the propulsion noise source no directivity is assumed. It should be noted that the transfer function is specific to the relative position of the receiver to the source position as indicated in the Table. In deriving the level difference values, the sources are assumed not to be divided over the two height positions as described in Section D.2.2.1, i.e. all the tyre/road noise is concentrated at a height of 0.01 m and all the propulsion noise is radiated from a point source at a height of 0.3 m in the case of a category 1 vehicles and 0.75m for category 2 and 3 vehicles.

Using the appropriate level difference levels for the propulsion noise source,  $D_i$ , shown in Table D.1 the third-octave band spectrum at the maximum pass-by noise level contributed by the propulsion noise source can be derived from the following expression:

$$L_{P,A \max,m,v,i} = L_{P,W,m,v,i} - D_i \text{ dB} \quad (\text{D.16})$$

where  $L_{P,W,m,v,i}$  is the third-octave band sound power level of the propulsion noise contribution derived from Equation D.13 (Note after subtracting the level difference values the levels need to be A-weighted).

*Table D.1: Differences between power and maximum levels for each source at 7.5 m and 1.2 m high relative to the receiver position*

Third-octave band, i, centre frequency (Hz)	Difference in Level (Sound Power – Maximum) (dB)		
	Tyre/road source (Ci)		Propulsion source (Di)
	All vehicles (source height 0.01m)	Category 1 vehicles (source height 0.3m)	All vehicles (source height 0.01m)
25	21.7	25	21.7
32	21.7	32	21.7
40	21.7	40	21.7
50	21.7	50	21.7
63	21.7	63	21.7
80	21.7	80	21.7
100	21.7	100	21.7
125	21.7	125	21.7
160	21.7	160	21.7
200	21.7	200	21.7
250	21.7	250	21.7
315	21.8	315	21.8
400	21.8	400	21.8
500	21.8	500	21.8
630	21.8	630	21.8
800	21.8	800	21.8
1000	21.8	1000	21.8
1250	21.8	1250	21.8
1600	21.9	1600	21.9
2000	21.9	2000	21.9
2500	22.0	2500	22.0
3150	22.1	3150	22.1
4000	22.3	4000	22.3
5000	22.5	5000	22.5
6300	22.8	6300	22.8
8000	23.4	8000	23.4
10000	24.1	10000	24.1

**Calculate the maximum level contribution by the tyre/road noise source:**

The next stage is to calculate the third-octave band sound pressure levels at the maximum pass-by noise level contributed from the tyre/road noise source.

This is obtained by substituting Equation D.16 into Equation D.15 together with the appropriate values of the converted third-octave band spectra of the maximum pass-by noise levels,  $L_{T,Am,m,v,i}$ , shown earlier.

**Derive the sound power spectrum of the tyre/road noise source:**

The input requirements of the HARMONOISE model is based on sound power levels. The next stage is to convert the A-weighted third-octave band spectra of the maximum pass-by noise level contributed by the tyre/road source to a linear, third-octave band sound power spectrum using the level differences given in Table D.1 for the tyre/road source,  $C_i$ .

In terms of sound power we have:

$$L_{R,W,m,v,i} = 10 \times \log \left( 10^{\frac{L_{T,Am,m,v,i}}{10}} - 10^{\frac{(L_{P,W,m,v,i} - D_i)}{10}} \right) + C_i \quad \text{dB} \quad (\text{D.17})$$

**Calculate the road surface correction for input to the HARMONOISE model:**

The HARMONOISE model is used to calculate the third-octave power spectrum for the tyre/road noise contribution for the reference surface,  $L_{ref,R,W,m,v,i}$ , where the road correction is set to zero. The road surface correction,  $\Delta_{road,m,v,i}$ , for the trial surface is then given by:

$$\Delta_{road,m,v,i} = L_{R,W,m,v,i} - L_{ref,R,W,m,v,i} \quad \text{dB} \quad (\text{D.18})$$

**Limitations of the method**

In the above description a number of assumptions have been made which may limit the accuracy of the method. In addition, there are a number of reasons for regarding the above procedure as an approximate including:

- The SPB noise spectrum is captured at the maximum A-weighted level. It is likely that a particular third-octave level will not be at the maximum value as assumed in the HARMONOISE model;
- The sound field around a vehicle is not uniform so that sound levels inferred from a single receiver is unlikely to be truly representative;
- The vehicle sub-sources are represented by two point sources, a low source position for the tyre/road noise source and a higher source position for the propulsion noise source. In reality the sub-sources will radiate from a number of different locations positioned around the vehicle.

### **An example of the road surface correction for hot rolled asphalt**

As an example, speed and maximum level functions were derived from SPB measurements on hot rolled asphalt (HRA) at each third-octave band. As there was no obvious systematic change in road surface correction with speed the average value was taken. At low and high frequencies the method was not able to calculate the correction factor since the propulsion noise alone appeared to explain the measured level. As explained above this may be because of the inaccuracies of the method. In these cases the correction was set at zero.

Based on this analysis the corrections for HRA averaged over the range 250 to 2,500 Hz for light vehicles is given in Table D.2 for the speed range 40 to 120 km/h. Below 40 km/h there was insufficient SPB data to make reliable estimates.

Table D.2: Road surface correction factors for category 1 vehicles

<b>Frequency (Hz)</b>	<b>&lt;250</b>	<b>250</b>	<b>315</b>	<b>400</b>	<b>500</b>	<b>630</b>	<b>800</b>
<b>Correction</b>	0	2.32	2.80	0.65	2.71	3.05	4.25
<b>Frequency (Hz)</b>	<b>1000</b>	<b>1250</b>	<b>1600</b>	<b>2000</b>	<b>2500</b>	<b>&gt;2500</b>	
<b>Correction</b>	5.21	3.49	1.40	-0.44	-2.25	0	

A similar procedure can be applied to medium heavy and heavy vehicles except that in this case the appropriate sound power levels should be used for propulsion noise. The propulsion noise height is set at 0.75 m.

## **D.3 Selection of reference surfaces**

Calculating the road surface correction term for existing national prediction methods may require the use of a reference surface. It is recommended for this purpose the member states use their existing reference. An example of such a reference is shown in Section D.3.1.

The HARMONOISE model uses a virtual reference surface, which overcomes differences between the current references of the different member states and this should be used when calculating  $L_{road,m,v}$ .

### **D.3.1 Example of existing national (Dutch) reference surface**

For the Dutch reference surface, dense asphalt concrete is used. On this road surface type, the reference sound level was determined from measurements taken on 11 surfaces

of grading 0/16 and 0/11, and having different ages. The correction to the virtual reference surface used in HARMONOISE is not known.

By averaging the SPB measurements on the reference road type, the A-weighted sound level of the reference was obtained together with the spectral distribution. The spectra are averaged to obtain the reference spectrum. The reference is defined for passenger cars, light trucks and heavy trucks.

The maximum A-weighted pass-by sound levels for passenger cars, light and heavy trucks travelling on the reference road surface are shown in Table D.3. Also the regression coefficients  $a_m$  and  $b_m$  are shown, from which the sound level  $L_{Amax,m,v}$  is deduced using the equation

$$\text{Maximum Noise Level, } L_{Amax,m,v} = a_m + b_m \cdot \log_{10}(v) \text{ dB} \quad (\text{D.19})$$

for each vehicle category,  $m$ , and  $v$  is the corresponding vehicle speed (km/h).

The reference speeds used in the Dutch method are 80 km/h for cars and 70 km/h for both light and heavy trucks and the corresponding maximum noise levels are highlighted in bold in Table D.3.

Table D.3: Maximum pass-by noise levels for different vehicle categories travelling on the Dutch reference road surface

Vehicle Category $m$	Maximum pass-by noise levels, dB, for a range of speeds, (km/h) <sup>1</sup>										$a_m$	$b_m$
	40	50	60	70	80	90	100	110	120	130		
Cars	64.9	68.1	70.7	72.9	<b>74.8</b>	76.5	78.0	79.4	80.6	81.8	12.0	33.0
Light trucks	75.9	77.9	79.6	<b>81.0</b>	82.2	83.2	84.2	85.1	85.9	86.6	42.4	20.9
Heavy trucks	78.0	80.2	82.0	<b>83.5</b>	84.8	86.0	87.0	87.9	88.8	89.6	42.0	22.5

<sup>1</sup> Values shown in bold are the reference noise levels,  $L_{Amax,m,vref}$  for each vehicle category,  $m$ , at the appropriate reference speed of 80km/h for cars and 70 km/h for light and heavy trucks.

In Table D.4 the normalised third-octave spectra for cars and both light and heavy trucks for the reference surface are presented.

Table D.4: Normalised spectra for cars and (light and heavy) trucks for the reference surface

Frequency (Hz)	Normalised reference spectrum (dB)		Frequency (Hz)	Normalised reference spectrum (dB)	
	Cars	(Light & Heavy) Trucks		Cars	(Light & Heavy) Trucks
50	-43.7	-41.8	800	-10.9	-6.9
63	-36.4	-34.0	1000	-7.1	-7.0
80	-32.5	-30.7	1250	-6.3	-8.3
100	-37.5	-32.6	1600	-7.7	-11.0
125	-29.7	-29.9	2000	-9.5	-12.9
160	-28.2	-27.9	2500	-12.0	-14.2
200	-26.1	-25.6	3150	-14.8	-16.5
250	-24.3	-23.0	4000	-17.7	-20.0
315	-22.6	-18.9	5000	-20.8	-21.8
400	-20.9	-16.0	6300	-23.6	-24.7
500	-17.4	-13.8	8000	-26.4	-28.4
630	-14.3	-8.4	10000	-30.5	-32.2

### D.3.2 Reference surface as described by HARMONOISE

The EU 5<sup>th</sup> framework projects HARMONOISE has provided the calculation method that is intended for noise mapping purposes after the year 2011.

The reference surface in the HARMONOISE model is defined as a virtual reference surface on which the basic values of HARMONOISE are based. It is the *average of SMA 0/11 and DAC 0/11 of one year or older but not at the end of its life time*. The choice of the reference surface for the  $D_{road}$  procedure (Section D.2.2.2) should preferably match this virtual reference.

However, HARMONOISE provides a procedure to enable measurements for a reference surface on other, similar, road surface types to be used. In this way, for example, specific country characteristics on the vehicle and tyre population can be accounted for, although the DAC 0/11 and SMA 0/11 may not be available in that country. The procedure is that SPB measurements on the following road surfaces are possible:

- DAC 0/11, DAC 0/12, DAC 0/13, DAC 0/14, DAC 0/16
- SMA 0/11, SMA 0/12, SMA 0/13, SMA 0/14, SMA 0/16

Then, depending on the actual reference surface used in a particular country and in a particular situation, one may make small corrections that normalize the chosen reference surface to the HARMONOISE virtual reference surface.

## Appendix E. SILVIA documents included on the CD-ROM

The following documents have been prepared as outputs from the SILVIA project, either as internal Work Package reports or as key project deliverables, and have been used as the basis for Chapters within this Guidance Manual. These documents can be found on the CD-ROM accompanying this Manual.

### E.1 Project Deliverables

#### E.1.1 Reports

- **Bendtsen H, Haberl J, Sandberg U, Watts G and Pucher E (2005).** *Traffic management and noise reducing pavements – Recommendations on additional noise reducing measures.* SILVIA Project Report SILVIA-DTF-DRI-08-11-WP5-020205.
- **van Blokland G and Roovers M S (2005).** *Measurement methods.* SILVIA Project Report SILVIA-M+P-015-03-WP2-120905.
- **Ejsmont J A, Mioduszewski P, Gardziejczyk W, Wisiosek A, Sandberg U, Padmos C, Roovers M S, Morgan P and Anfosso-Lédée F (2004).** *Development of procedures for certifying noise testing equipment.* SILVIA Project Report SILVIA-TUG-006-10-WP2-160104.
- **Elvik R and Greibe P (2005).** *Safety aspects related to low noise road surfaces.* SILVIA Project Report SILVIA-DTF-ATKINS-001-03-WP3--091203.
- **Haberl J, Lengheim T, Pucher E, Litzka J, Bendtsen H, Watts G, Parry A, Anfosso-Lédée, Sandberg U, Lelong J, Hamet J-F, van Blokland G J, Kuijpers A, Ejsmont J and Mioduszewski P (2005).** *Integration of low-noise pavements with other noise abatement measures.* SILVIA Project Report SILVIA-TUW-052-04-WP5-220305.
- **Nilsson R, Nordlander JO and Silwa N (2005).** *Design guidelines for durable, noise reducing pavements.* SILVIA Project Report SILVIA-SKANSKA-018-01-WP4-231105.
- **Padmos C, Morgan P, Abbott P, van Blokland G, Roovers M S, Bartolomaeus W and Anfosso-Lédée F (2005).** *Classification scheme and COP method.* SILVIA Project Report SILVIA-DWW-025-014-WP2-151005.
- **Pucher E, Litzka J, Haberl J, Girard J, Ejsmont J, Lelong J, Hamet JF, Sandberg U, Bendtsen H, Watts G, Parry A, van Blokland G and Kuipers A**

(2004). *Recommendations on specifications for tyre and vehicle requirements*. SILVIA Project Report SILVIA-TUW-039-02-WP5-120304.

- **Saelensminde K and Veisten K (2005)**. *Cost-benefit analysis*. SILVIA Project Report SILVIA-TOI-004-01-WP3-030505.
- **Veisten K and Saelensminde K (2004)**. *Summary of net impacts on sustainability from a change to porous asphalt*. SILVIA Project Report SILVIA-TOI-002-06-WP3-300304.

### E.1.2 Tools

- *Cost-Benefit Analysis Tool (MS EXCEL Spreadsheet)*. SILVIA Project Output SILVIA-TOI-004-01-WP3-030505.

## E.2 Other project reports

### E.2.1 SILVIA reports

- **Andersen B, Bendtsen H and Larsen L E (2005)**. *Acoustic performance of low noise road pavements*. SILVIA Project Report SILVIA-DTF-DRI-010-02-WP4-290605.
- **Anfosso-Lédée F (2003)**. *A former LCPC experimental campaign about repeatability and reproducibility of SPB and CPB measurement methods*. SILVIA Project Report SILVIA-LCPC-002-00-WP2-170403.
- **Anfosso-Lédée F (2004)**. *The propagation filter between CPX and CPB measurements*. SILVIA Project Report SILVIA-LCPC-006-01-WP2-300404.
- **Anfosso-Lédée F, Haberl J and Watts G (2005)**. *Combination of low-noise road surfaces with road and building equipment*. SILVIA Project Report SILVIA-LCPC\_TUW-009-02-WP5-020205.
- **Bendtsen H (2004)** *Rolling resistance, fuel consumption and emissions: A literature review*. SILVIA Project Report SILVIA-DTF-ATKINS-007-02-WP3-060204.
- **Brosseaud Y and Anfosso-Lédée F (2005)**. *Review of existing low-noise pavement solutions in France*. SILVIA Project Report SILVIA-LCPC-011-01-WP4-310505.
- **Cesbron J and Anfosso-Lédée F (2005)**. *A characterization method of road stiffness for tyre/road noise*. SILVIA Project Report SILVIA-LCPC-010-01-WP2-020505.



- **Ejsmont J A Taryma S, Mioduszewski P, Wozniak R, Ronowski G, Cwikla-Duda M and Wisiorek M (2005).** *Rolling resistance results.* SILVIA Project Report SILVIA-TUG-011-02-WP4-050114.
- **James E (2003).** *A literature review on the effect of porous asphalt roads on water pollution.* SILVIA Project Report SILVIA-TRL-008-01-WP3-240703.
- **Hamet JF and Klein P (2005).** *ENR<sub>a</sub>, Expected pass-by noise level reduction from acoustic absorption of the road surface.* SILVIA Project Report SILVIA-INRETS-018-02-WP2-040505.
- **Klein P and Hamet JF (2005).** *END<sub>T</sub>, Expected pass-by noise level difference from texture level variation of the road surface.* SILVIA Project Report SILVIA-INRETS-021-01-WP2-070705.
- **Kuijpers A H W M and Schwanen W (2005).** *Development of a measurement system for mechanical impedance.* SILVIA Project Report SILVIA-M+P-013-01-WP2-230605.
- **Mioduszewski P, Gardziejczyk W and Wisiorek M (2005).** *Repeatability and reproducibility of CPX round-robin test.* SILVIA Project Report SILVIA-TUG-007-04-WP2-120505.
- **Morgan P A (2005).** *Performing static and dynamic measurements of the absorption coefficient of low-noise road surfaces using the extended surface method.* SILVIA Project Report SILVIA-TRL-007-05-WP2-010405.
- **Pucher E, Litzka J, Haberl J and Girard J (2004).** *Report on recycling of porous asphalt in comparison with dense asphalt.* SILVIA Project Report SILVIA-TUW-036-01-WP3-260204.
- **Roovers M S and Peeters H M (2004).** *CPX-SPB/CPB relation.* SILVIA Project Report SILVIA-M+P-008-00-WP2-080904.
- **Roovers M S (2005a).** *Round-robin test for measurements devices on road acoustics.* SILVIA Project Report SILVIA-M+P-009-03-WP2-230605.
- **Roovers M S (2005b).** *SPB study.* SILVIA Project Report SILVIA-M+P-011-00-WP2-230205.
- **Sandberg U, Kalman B and Nilsson R (2005).** *Design guidelines for construction and maintenance of poroelastic road surfaces.* SILVIA Project Report SILVIA-VTI-005-02-WP4-141005.
- **Sandberg U and Kalman B (2005).** *The poroelastic road surface – Results of an experiment in Stockholm.* SILVIA Project Report SILVIA-VTI-006-00-WP4-030605, (same document as [111]).
- **Sanders P (2005).** *Review of recycling and rejuvenation procedures.* SILVIA Project Report SILVIA-TRL-016-02-WP4-240605.

## E.2.2 Other project reports

- **Klein P and Hamet J-F (2004).** *Road texture and rolling noise. An envelopment procedure for tire/road contact.* Technical report LTE 0427. INRETS, France.

## E.2.3 Other documents

- *SILVIA Cost Benefit Analysis Tool – Example application: Norwegian urban ring-road, 70 km/h speed limit. CBA Model Example - Norway ring-road 70 kmh.xls*
- *SILVIA Cost Benefit Analysis Tool – Example application: Danish city street, 50 km/h speed limit. CBA Model Example - Norway city street 50 kmh.xls*
- *SILVIA Cost Benefit Analysis Tool – Example application: Danish ring-road, 70 km/h speed limit. CBA Model Example - Denmark ring-road 70kmh.xls*
- *SILVIA Cost Benefit Analysis Tool – Example application: Danish freeway, 110 km/h speed limit. CBA Model Example - Denmark freeway 110kmh.xls*





arsenal Research, Austria  
www.arsenal.ac.at



TKTI, Lithuania  
www.tkti.lt



BRRC, Belgium  
www.brrc.be



INRR, Luxembourg



CRBL, Bulgaria



RWS DWW, Netherlands  
www.minvenw.nl/rws/dww



IGH, Croatia  
www.igh.hr



NPRA, Norway  
www.vegvesen.no



CDV, Czech Republic  
www.cdv.cz



IBDiM, Poland  
www.ibdim.edu.pl



DRI, Denmark  
www.roadinstitute.dk



LNEC, Portugal  
www-ext.lnec.pt



TECER, Estonia  
www.teed.ee



CESTRIN, Romania  
www.cestrin.ro



LCPC, France  
www.lcpc.fr



IP, Serbia-Montenegro  
www.highway.co.yu



BASt, Germany  
www.bast.de



VUD, Slovakia  
www.vud.sk



KEDE, Greece



ZAG, Slovenia  
www.zag.si



KTI, Hungary  
www.kti.hu



CEDEX, Spain  
www.cedex.es



PRA, Iceland  
www.vegagerdin.is



VTI, Sweden  
www.vti.se



NRA, Ireland  
www.nra.ie



LAVOC, Switzerland  
lavoc.epfl.ch



ANAS, Italy  
www.enteanas.it



TRL, United Kingdom  
www.trl.co.uk



LAD, Latvia  
www.lad.lv



www.fehrl.org